

BR 10e · PTFE-lined centric Control and Shut-off Butterfly valve DIN- and ANSI-Version



Application

Tight-closing, centric butterfly control valve with PTFE lining for process engineering and plants with industrial requirements, especially suitable for corrosive process media:

- **Nominal size NPS2 to 16 and DN 50 to 400**
- **Nominal pressure cl150 and PN 10, PN 16**
- **Temperatures -31 °F to +392 °F (-35 °C to +200 °C)**

The valve consists of a PTFE-lined butterfly valve with a pneumatic rotary actuator or a hand-operated actuator. The valve is designed according to the modular-assembly principle and has the following features:

- Body style
 - Lug-Type or
 - Wafer-Type
- Valve body made of spheroidal graphite iron EN-JS 1049 (07043/A395) with PTFE-liner (min. 3 mm wall thickness)
- Valve disc and shaft undivided made of 1.4313 with PTFE liner (min. 3 mm wall thickness)
- All wetted parts are PTFE coated
- High kv value obtained by utilizing a disc designed to provide favourable flow
- Good control characteristic
- Trouble-free installation even in insulated lines due to the long collar on the body
- TA-Luft acc. to VDI 2440
- Material is acc. to FDA standards
- Connecting flange for actuators acc. to DIN ISO 521 1
- Face-to-face dimensions acc. to DIN EN 558, row 20
- Face-to-face dimensions acc. to API 609 Class 150
- High-quality 2-component PU coating (RAL 1019) as protection against corrosive atmosphere and corrosive formation

Versions

BR 10e butterfly valve are optionally available in the following versions:

- Butterfly valve with lever and ratchet
- Butterfly valve with manual gear
- Shut-Off Butterfly valve with pneumatic quarter-turn actuator BR 31a
- Control butterfly valve with pneumatic diaphragm multi-turn actuator BR 30a

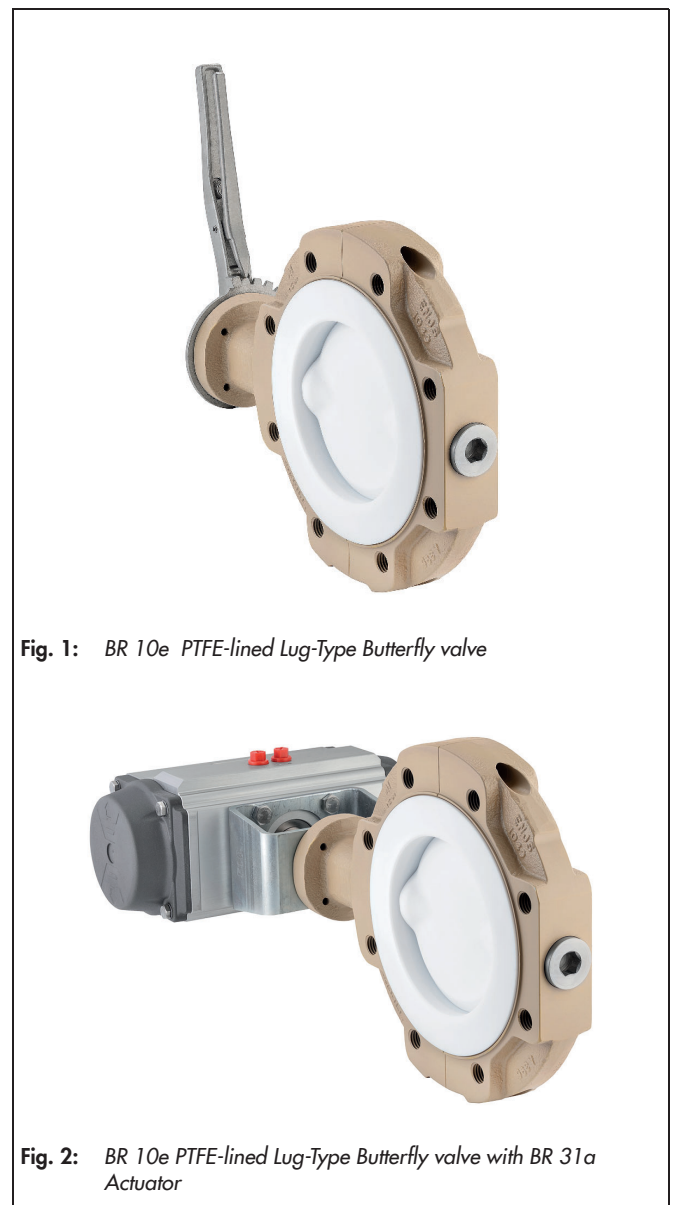

Fig. 1: BR 10e PTFE-lined Lug-Type Butterfly valve

Fig. 2: BR 10e PTFE-lined Lug-Type Butterfly valve with BR 31a Actuator

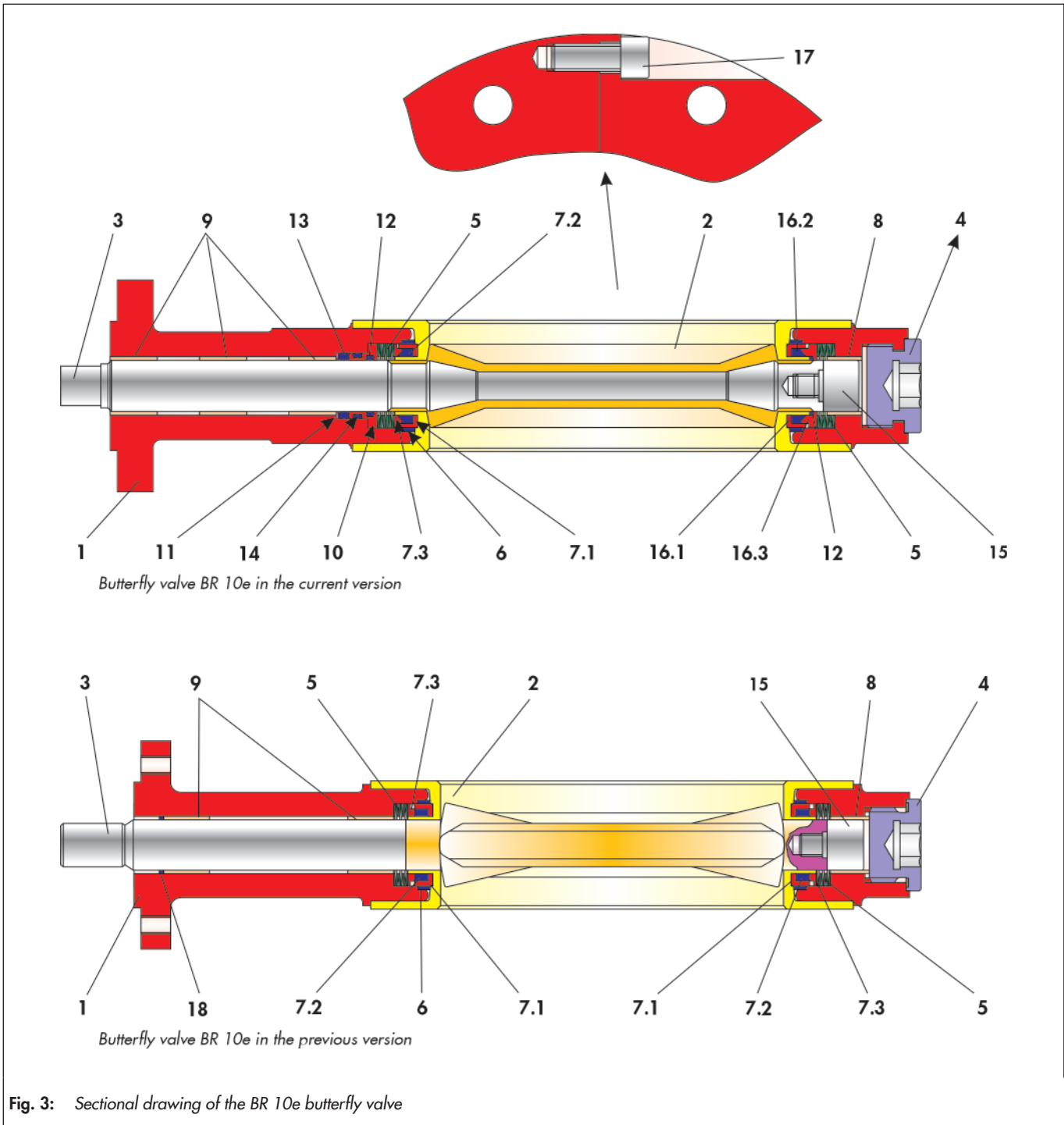

Fig. 3: Sectional drawing of the BR 10e butterfly valve

Table 1: Parts list of the BR 10e butterfly valve

Item	Description
1	Valve body
2	Liner
3	Valve disc
4	Screw plug
5	Disc spring set
6	Inlay
7	Inlay press packing
7.1	Disc

Item	Description
7.2	Packing inlay
7.3	Thrust ring
8	Bearing bush
9	Bearing bush
10	Bush
11	Disc
12	O-ring
13	O-ring

Item	Description
14	O-ring
15	Bearing screw
16	Inlay press packing
16.1	Disc
16.2	Packing inlay
16.3	Thrust ring
17	Screw
18	O-ring

Special versions

- Valve disc of special material
- 1 pcs disc/shaft of stainless steel (1.4469/A890-A995 5A)
- Brine-execution
- Lining PTFE - conductive
- Low temperature version (-46 °C) with body material A352 LCC available
- Electric rotary actuator

Principle of operation

The process medium can flow through the butterfly valve in either direction.

The position of the valve disc (3) determines the flow rate through the free area between the disc and the liner (2).

The shaft of the valve disc (3) is sealed by a packing (7 and 16) which is spring supported by disc springs (5) positioned above the packing and O-rings (12, 13 and 14).

Elastomer inserted between the valve disc (3) and the liner (2) acts as a seal.

The centric bearing design of the shaft and the valve disc designed for an optimal flow help achieve a good control characteristic and a high kv value.

Opening angles

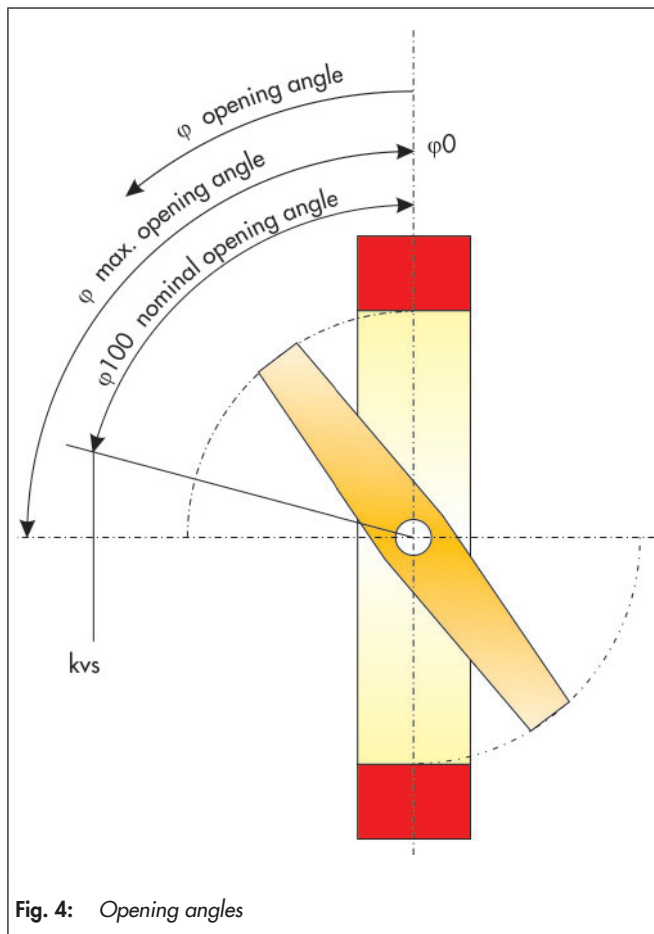

Failure position

Depending on assembly position of the pneumatic actuator, the valve has two fail-safe positions which become effective when the air pressure in the actuator is relieved or when the supply air fails:

- **Butterfly valve with fail-close actuator**

While air failure, the valve is closed. The valve opens when the signal pressure increases, acting against the force of the springs.

- **Butterfly valve with fail-open actuator**

While air failure, the valve opens. The valve closes when the signal pressure increases, acting against the force of the springs.

i Info

Before using the butterfly valve in hazardous areas, check whether this is possible acc. to ATEX 2014/34/EU by referring to the mounting and operating instructions ► EB 10e.

Optional material combinations

For best adaption to process conditions, it is possible to optimize ball valve by modification of materials (eg. body, shaft, ball and sealing).

Additional accessories

The following accessories are available (separately or in combination):

- Locking device
- Pneumatic or electric quarter-turn actuators
- Positioner
- Limit switches
- Solenoid valves
- Filter regulator
- Gauge block

Further accessories are possible on customer request.

Table 2: General technical data

	DIN	ANSI
Nominal size	DN 50 ... 400	NPS2 ... 16
Nominal pressure	PN 10 / 16	cl150
End connection	can be mounted between PN 10/16	can be mounted between cl150
Temperature range	see Pressure-Temperature diagram	
Rangeability	50 : 1	
Leakage rate	Leakage rate A acc. to DIN EN 12266-1, P12 (Class VI acc. to ANSI / FCI 70-2-2006)	
Face to face	DIN EN 558, row 20	API 609 Class 150

Table 3: Materials

	DIN	ANSI
Valve body	EN-JS 1049 / 0.7043 with PTFE-Liner	A395 with PTFE-Liner
Elastomer	Viton	
O-rings	Viton (Standard) / FFKM or Hypalon (on request)	
Disc / Shaft	1.4313 / PTFE or 1.4469	
Bearing bush	PTFE with 40% glass	
Packing	PTFE-Viton	
Disc spring set	1.8159 beschichtet	
Coating	Two-component polyurethane coat, grey beige (RAL 1019) / Special coating available on request	

Table 4: Terms for noise level calculation

z-values for noise level calculation acc. to VDMA 24422 and terms for control valve sizing acc. to DIN EN 60534.

Opening angle φ	10°	20°	30°	40°	50°	60°	70°	80°	90°
FL	0.95	0.95	0.92	0.83	0.73	0.65	0.58	0.53	0.50
xT	0.75	0.75	0.73	0.58	0.46	0.36	0.29	0.24	0.21
Z	0.35	0.30	0.25	0.20	0.17	0.14	0.12	0.11	0.10

Correction terms

With liquids $\Delta LF = 0$,

With gases and vapors $\Delta LG = 0$

Table 5: Torque and breakaway torques

DN	NPS	Perm. Torque MDmax. in Nm	Required Torque Md in Nm		
			5 bar (73 psi)	10 bar (145 psi)	16 bar (232 psi)
50	2	250	40	45	50
80	3	250	50	55	60
100	4	275	70	78	85
150	6	475	140	156	170
200	8	643	230	262	290
250	10	1026	300	337	375
300	12	1026	420	471	520
400	16	3270	910	980	1060

The breakaway torques specified are average values which were measured with air at 68°F (20°C) with the corresponding differential pressures. Operating temperature, process medium and long operating times may affect the permissible torques and breakaway torques considerably. The maximum permissible torques listed apply to the standard materials specified in Table 3.

Pressure-Temperature diagram

The area of application is determined by the pressure-temperature diagram. Process data and the process medium can affect the values in the diagram.

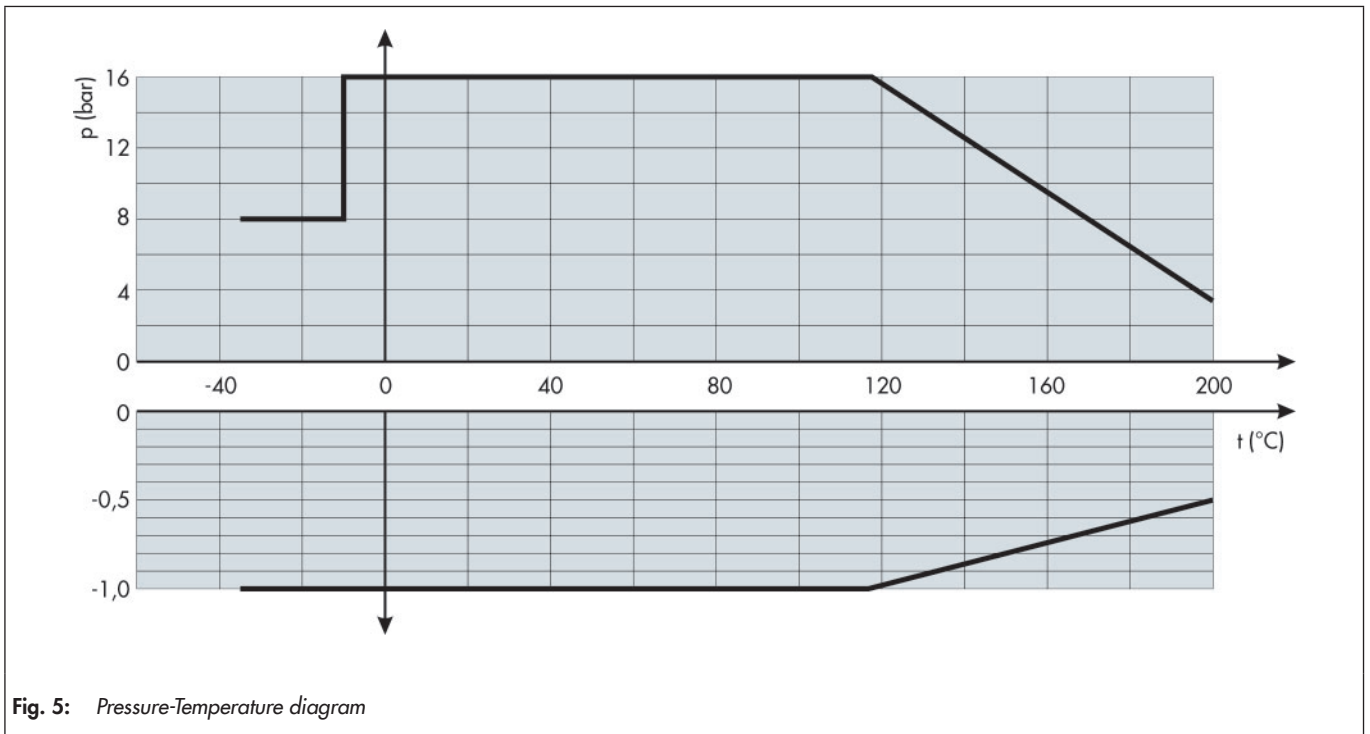
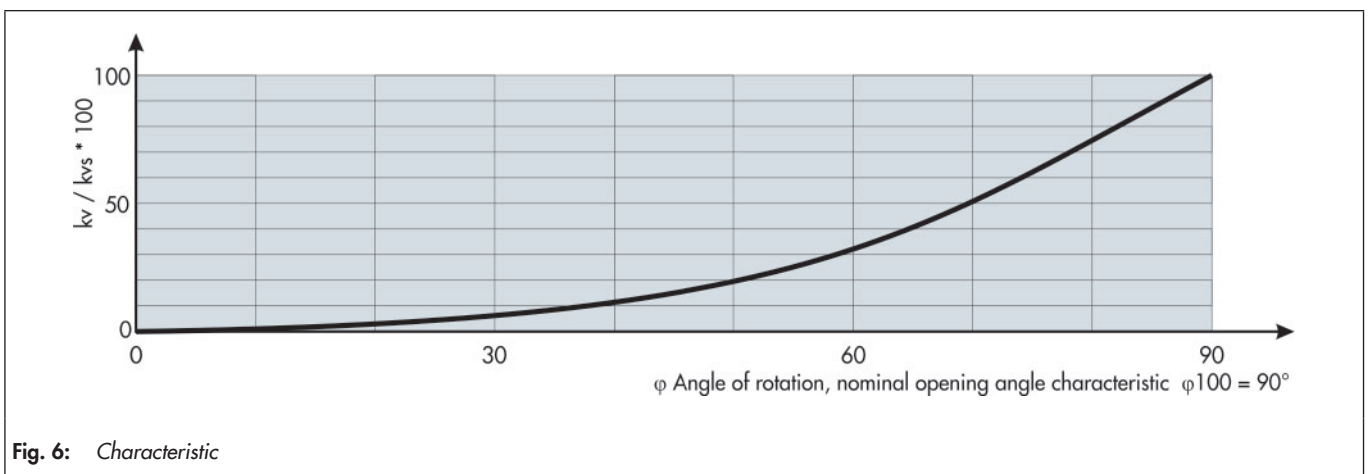

Table 6: kv values and associated opening angles

DN	NPS	φ Opening angle								
		10°	20°	30°	40°	50°	60°	70°	80°	90°
50	2	1.5	7	16	35	60	92	132	170	190
80	3	3.5	14	33	57	95	146	240	380	510
100	4	5.5	25	54	95	155	240	395	620	820
150	6	14.5	52	120	215	342	547	940	1380	1800
200	8	20.5	95	215	376	590	940	1540	2400	3200
250	10	33	154	342	607	940	1540	2310	4000	5300
300	12	49	222	504	855	1455	2310	3760	6000	8000
400	16	103	515	960	1465	2450	4280	6523	9210	11420

Characteristic



Dimensions and weights:

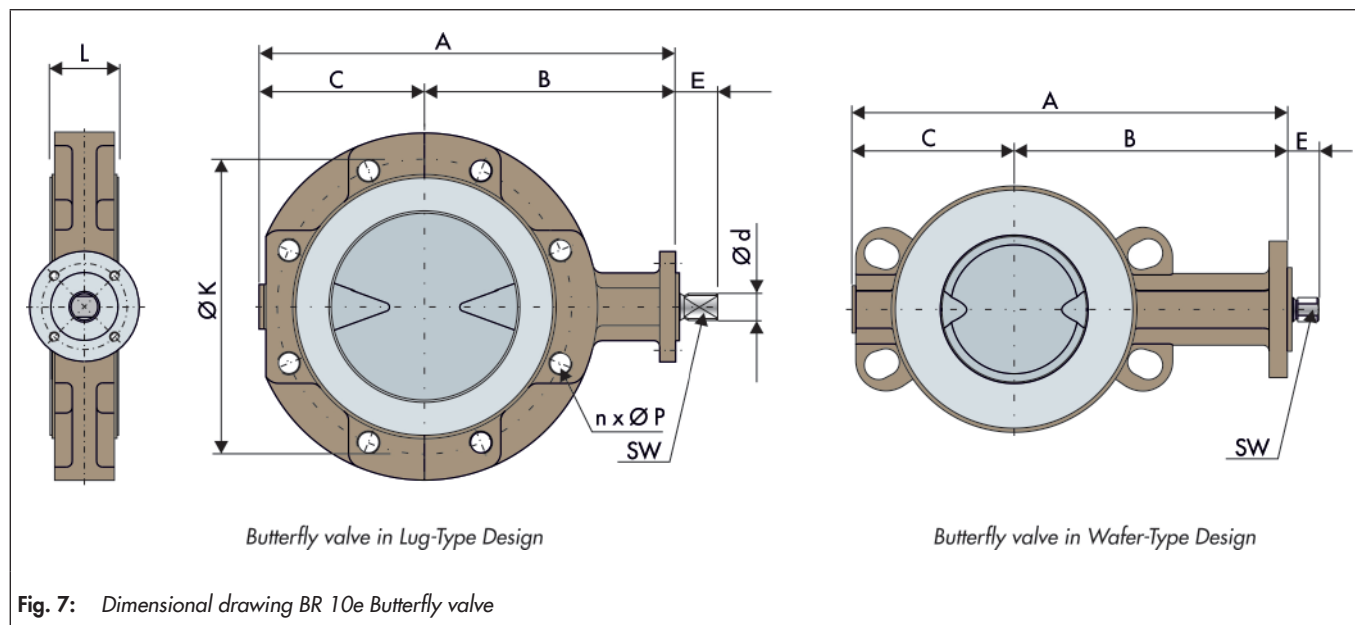

Fig. 7: Dimensional drawing BR 10e Butterfly valve

Table 7: Dimensions in mm and weights in kg

DN	50	80	100	150	200	250	300	400	
NPS	2	3	4	6	8	10	12	16	
L	row 20 (PN10/16)	43	46	52	56	60	68	78	102
	API 609 H150 (cl150)	43	46	52	56	60	68	78	102
A	212	253	289	341	403	465	505	640	
B	132	156	181	206	236	261	266	341	
C	80	97	103	135	167	204	239	299	
ØK	PN 10	125	160	180	240	295	400	515	
	PN 16	125	160	180	240	295	355	410	
	d150	120.7	152.4	190.5	241.3	298.5	362	431.8	
n x ØP	PN 10	4x M16	8x M16	8x M16	8x M20	8x M20	12x M20	12x M20	16x M24
	PN 16	4x M16	8x M16	8x M16	8x M20	12x M20	12x M24	12x M24	16x M27
	d150	4x 5/8"	4x 5/8"	8x 5/8"	8x 3/4"	8x 3/4"	12x 7/8"	12x 7/8"	16x 1 1/8"
Ød	14	16	16	24	24	28.5	28.5	42	
E	18	18	21	24	24	29	29	37	
SW	11	11	14	17	17	22	22	30	
DIN ISO Connection	F05	F05	F07	F07	F07	F10	F10	F14	
Weight ca. kg	Lug-Type	5.1	7.8	8.8	15.2	24.5	36.3	52.6	105.7
	Wafer-Type	2.5	3.8	5.7	9.3	15.5	24.5	31.3	66.9

Selecting and sizing the butterfly valve:

1. Calculate the appropriate kv value
2. Select the nominal size and the kvs value from Table 6.
3. Comparing the operation conditions in acc. to the pressure-temperature diagram
4. Select a suitable actuator
5. Select additional equipment

i Info

All relevant details regarding the version ordered, which deviate from the specified version in this technical description data, can be taken if required, from the corresponding order confirm.

Ordering text

PTFE-lined butterfly valve BR 10e
DN / NPS
PN / ANSI Class
optional special version

Hand-operated actuator or actuator (brand name):
Supply pressure: bar,
fail-safe position:

Limit switch (brand name):
Solenoid valve (brand name):
Positioner:

Others: