

APPLICATION NOTES

AB 0100 EN

Servicing SAMSON Products

Tightening Torques · Lubricants · Tools



Electric and Pneumatic Control Valves

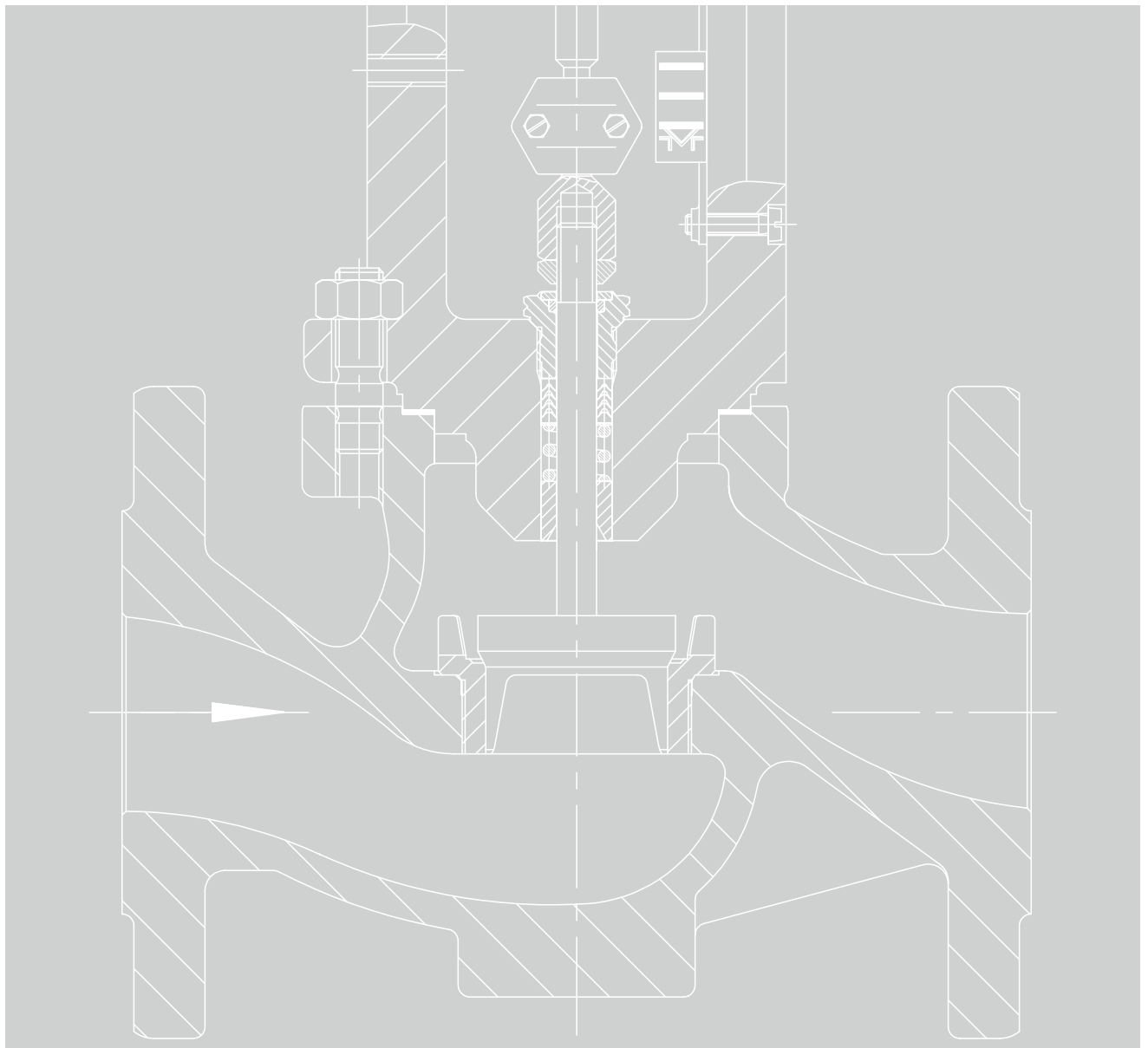

Contents

Information for All Valve Series and Types

1	Contact data of SAMSON's After-sales Service	1
2	Safety instructions and measures	1
3	Special tools for tightening torques	1
3.1	Torque wrench	1
3.2	Torque multiplier	2
3.3	Adapter	2
3.4	Pneumatic adapter	3
3.5	Hydraulic power tool.....	3
4	Width across flats	4

Series 240 Valves

1	Information on Series 240 Valves	5
1.1	Technical data	5
1.2	Types of pressure balancing	5
1.3	Parts	6
2	Tightening torques	7
2.1	Tightening torques to install the seat	7
2.2	Tightening torques for connection of body and bonnet/flange	8
2.3	Tightening torques for plug stem connection in versions with insulating section or bellows seal	8
2.4	Tightening torques for screw plug at test connection	8
2.5	Tightening torques for nuts (bellows seal)	8
2.6	Tightening torques for connection of bonnet/flange with insulating section or bellows seal.....	8
2.7	Tightening torques for threaded bushing	8
2.8	Tightening torques for stem connector nut and lock nut.....	9
2.9	Tightening torques for stem connector clamps	9
3	Lubricant	10
3.1	Recommended lubricant	10
3.2	Lubricant for adjustable packings	10
3.3	Lubricant sorted by parts and versions	11
4	Tools	12
4.1	Pliers for assembly and disassembly	12
4.2	Packing extractor	12
4.3	Tool for high-temperature packings.....	12

Type 3241 Valve

1	Information on Type 3241 Valve	13
1.1	Technical data	13
1.2	Note on different seat wrenches for Type 3241 (DN 250/NPS 10)	13
1.3	Parts	15
2	Tools	15
2.1	Tools for standard version	15
2.1.1	Seat wrenches	15
2.1.2	Packing tools	16
2.2	Tools for version with insulating section or bellows seal	17

2.3	Tools for version with pressure balancing	18
2.4	Tools for PSA valves	18
2.5	Tools for valves with AC trims.....	19
2.6	Lifting equipment	20

Type 3244 Valve

1	Information on Type 3244 Valve	21
1.1	Technical data	21
1.2	Parts	21
2	Tightening torques.....	21
2.1	Tightening torques for screws to mount the plug in diverting valves	21
2.2	Other tightening torques.....	21
3	Tools.....	22
3.1	Tools for standard version	22
3.1.1	Seat wrenches	22
3.1.2	Packing tools	23
3.2	Tools for version with insulating section or bellows seal	23
3.3	Tools for mixing valves with insulating section or bellows seal	24
3.4	Tools for PSA valves	24

Type 3248 and Type 3246 Valves

1	Information on Type 3248 and Type 3246 Valves	25
1.1	Technical data for Type 3248.....	25
1.2	Note on special versions of Type 3248	25
1.3	Technical data for Type 3246.....	26
1.4	Note on versions of Type 3246	26
1.5	Note on the use in air separation units (Type 3246 and Type 3248).....	27
1.6	Parts	27
2	Tightening torques.....	30
2.1	Tightening torques for Type 3248 (DN 15 to 150/NPS ½ to 6)	30
2.1.1	Tightening torques to install the seat	30
2.1.2	Tightening torques for nuts on body and bellows seal.....	30
2.1.3	Tightening torques for bolts on flange	30
2.1.4	Tightening torques for plug stem connection	30
2.1.5	Tightening torques for spacer stem	31
2.1.6	Tightening torques for nuts on guide bushing (bellows).....	31
2.1.7	Tightening torques for screw plug at test connection	31
2.1.8	Tightening torques for nuts (bellows seal)	31
2.1.9	Tightening torques for nuts on bellows seal and bonnet/flange	31
2.1.10	Tightening torques for threaded bushing	32
2.1.11	Tightening torques for stem connector nut and lock nut.....	32
2.2	Tightening torques for Type 3248 (DN 10/NPS ½, micro-flow valve).....	32
2.3	Tightening torques for Type 3248 in DN 25 to 150, aluminum angle valve (Linde version).....	33
2.3.1	Tightening torques to install the seat	33
2.3.2	Tightening torques for nuts on body and bellows seal.....	33
2.3.3	Tightening torques for plug stem connection	33
2.3.4	Tightening torques for spacer stem	33
2.3.5	Tightening torques for nuts on guide bushing	33
2.3.6	Tightening torques for screw plug at test connection	34
2.3.7	Tightening torques for nuts (bellows seal)	34
2.3.8	Tightening torques for nuts on bellows seal and bonnet/flange	34

2.3.9	Tightening torques for threaded bushing	34
2.3.10	Tightening torques for stem connector nut and lock nut.....	34
3	Tools.....	35
3.1	Tool sets	35
3.2	Extensions	35
3.2.1	Extensions for the standard version.....	36
3.2.2	Extensions for Linde version	36
3.3	Further tools for standard version	37
3.4	Further tools for Linde and Messer versions	37
3.5	Additional clamping elements	38

Type 3249 Valve

1	Information on Type 3249 Valve	39
1.1	Technical data	39
1.2	Note on Type 3249.....	39
1.3	Note on actuators	39
1.4	Parts	40
2	Tightening torques.....	41
2.1	Tightening torques for Type 3249 with Type 3271 or Type 3277 Actuator	41
2.1.1	Tightening torques for connection of plug and plug stem	41
2.1.2	Tightening torques for connection of body and valve bonnet (special version)	41
2.1.3	Tightening torques for connection of actuator stem and plug stem	41
3	Lubricant.....	42
3.1	Recommended lubricant	42
3.2	Lubricant sorted by parts and versions.....	42
4	Tools.....	42

Series 250 and 280 Valves

1	Information on Series 250 and 280 Valves	43
1.1	Technical data of Series 250 Valves.....	43
1.2	Technical data of Series 280 Valves.....	43
1.3	Types of pressure balancing.....	43
1.4	Note on specifications	43
1.5	Parts	44
2	Tightening torques.....	45
2.1	Tightening torques to install the seat	45
2.2	Tightening torques for connection of body and bonnet	46
2.2.1	Metal body gasket · All body materials.....	46
2.2.2	Body gasket: serrated gasket · All body materials except 2.4360/B164 N04400	48
2.2.3	Body gasket: serrated gasket · Body materials 2.4360/B164 N04400 only.....	49
2.2.4	Body gasket: serrated gasket · All body materials · Bolts with Xylan® coating.....	51
2.3	Tightening torques for connection of bellows seal and bellows seal bonnet	52
2.3.1	All body materials.....	52
2.3.2	Special version with large plug stem	53
3	Lubricant.....	54
3.1	Recommended lubricant	54
3.2	Lubricant for adjustable packings	54
3.3	Lubricant sorted by parts and versions.....	55

4	Tools	56
4.1	Tools for assembly and disassembly.....	56
4.2	Lifting equipment	56

Type 3251 and Type 3256 Valves

1	Information on Type 3251 and Type 3256 Valves	59
1.1	Technical data for Type 3251	59
1.2	Technical data for Type 3256.....	59
1.3	Parts	59
2	Tools	60
2.1	Tools for standard version	60
2.1.1	Seat wrenches	60
2.1.2	Tools for guide bushing	61
2.2	Tools for version with insulating section or bellows seal	62
2.2.1	Tools for guide bushing	62
2.3	Tools for version with pressure balancing	63
2.4	Tools for PSA valves	64
2.4.1	Tools for guide bushing	64
2.5	Tools for valves with AC trims.....	64
2.5.1	Seat wrenches for AC trims.....	64
2.5.2	Socket for AC trims	65

Type 3253 Valve

1	Information on Type 3253 Valve	67
1.1	Technical data	67
1.2	Parts	67
2	Tightening torques	70
2.1	Tightening torques for nut at the plug stem end in version with standard bonnet or insulating section	70
2.2	Tightening torques for nut at the plug stem end in version with bellows seal	70
2.3	Tightening torques for seat holder in version with bellows seal	70
2.4	Other tightening torques.....	70
3	Tools	70
3.1	Seat wrenches	70
3.1.1	Seat wrenches for single-piece body.....	70
3.1.2	Seat wrenches for multi-piece body	71
3.1.3	Additional tools	71

Type 3254 Valve

1	Information on Type 3254 Valve	73
1.1	Technical data for Type 3254.....	73
1.2	Parts	73
2	Tools	74
2.1	Tools for standard version	74
2.1.1	Seat wrenches	74
2.2	Tools for version with pressure balancing	76
2.3	Tools for valves with AC trims.....	76
2.3.1	Seat wrenches for AC trims.....	76

Type 3259 Valve

1	Information on Type 3259 Valve	79
1.1	Technical data	79
1.2	Parts	79
2	Tightening torques	80
2.1	Tightening torques to install the seat	80
2.2	Tightening torques for connection of body and intermediate piece	80
2.3	Tightening torques for connection of threaded flange and bellows seal	80
3	Tools	81
3.1	Seat wrenches	81

Type 3281 and Type 3286 Steam Conditioning Valves

1	Information on Type 3281 and Type 3286 Valves	83
1.1	Technical data for Type 3281	83
1.2	Technical data for Type 3286	83
1.3	Parts	83
2	Tools	84
2.1	Seat wrenches	84

Series 290 Valves

Type 3291 and Type 3296 Valves

1	Information on Series 290 Valves	87
1.1	Technical data	87
1.2	Parts	87
2	Tightening torques	90
2.1	Tightening torques for connection of body and bonnet/insulating section	90
2.2	Tightening torques for connection of bellows seal and bellows seal bonnet	90
3	Lubricant	91
3.1	Recommended lubricant	91
3.2	Lubricant sorted by parts and versions	91
4	Tools	92
4.1	Standard tools	92
4.2	Packing tools	92

Series V2001

Type 3321 Valve

1	Information on Type 3321 Valve	93
1.1	Technical data	93
1.2	Parts	94
2	Tightening torques	95
2.1	Tightening torques to install the seat	95
2.2	Tightening torques for connection of body and bonnet	95
2.3	Tightening torques for threaded bushing	96
2.4	Tightening torques for central nuts	96

3	Lubricant	96
3.1	Recommended lubricant	96
3.2	Lubricant sorted by parts and versions	96
4	Tools	97
4.1	Seat wrenches	97
4.2	Packing extractor	97

Type 3321CT Valve (Clean Tech)

1	Information on Type 3321CT Valve	99
1.1	Technical data	99
1.2	Parts	100
2	Tightening torques	101
2.1	Tightening torques to install the seat	101
2.2	Tightening torques for connection of body and bonnet	101
2.3	Tightening torques for connection of plug stem and actuator stems	101
2.4	Tightening torques for connection of bonnet and Type 3379 Actuator.....	101
3	Lubricant	102
3.1	Recommended lubricant	102
3.2	Lubricant sorted by parts	102
4	Tools	103
4.1	Seat wrenches	103
4.2	Packing extractor	103

Type 3323 Three-way Valve

1	Information on Type 3323 Valve	105
1.1	Technical data	105
1.2	Parts	105
2	Tightening torques	108
2.1	Tightening torques to install the seat	108
2.1.1	Top seat	108
2.1.2	Bottom seat.....	108
2.2	Tightening torques for connection of body and bonnet	109
2.3	Tightening torques for threaded bushing	109
2.4	Tightening torques for the hex nut at the plug stem end	109
2.5	Tightening torques for central nuts	109
3	Lubricant	110
3.1	Recommended lubricant	110
3.2	Lubricant sorted by parts and versions	110
4	Tools	111
4.1	Seat wrenches	111
4.2	Assembly tools.....	112

Type 3349 Valve

1	Information on Type 3349 Valve	113
1.1	Technical data	113
1.2	Note on Type 3349.....	113

1.3	Note on actuators	113
1.4	Parts	114
2	Tightening torques.....	115
2.1	Tightening torques for Type 3349 with Type 3271 or Type 3277 Actuator	115
2.1.1	Tightening torques for connection of plug and plug stem	115
2.1.2	Tightening torques for connection of body and valve bonnet.....	115
2.2	Tightening torques for Type 3349 with Type 3379 Actuator	115
2.2.1	Tightening torques for connection of plug and plug stem	115
2.2.2	Tightening torques for connection of body and valve bonnet.....	116
2.2.3	Tightening torques for connection of actuator stem and plug stem	116
3	Lubricant.....	116
3.1	Recommended lubricant	116
3.2	Lubricant sorted by parts and versions.....	116
4	Tools.....	117

Valves Not Assigned to a Valve Series

Type 3310 Segmented Ball Valve, edition 2020

1	Information on Type 3310 Valve	119
1.1	Technical data	119
1.2	Note on Type 3310.....	119
1.3	Note on actuators	119
1.4	Parts	120
2	Tightening torques.....	120
2.1	Tightening torques for connection of valve and pipeline	120
2.1.1	ANSI version	121
2.1.2	DIN version	121
2.2	Tightening torques for retaining screws (85) on the segmented ball (07)	121
2.3	Tightening torques for the screws (60 or 65/75) on packing gland (15).....	121
3	Lubricant.....	121
3.1	Recommended lubricant (standard version)	121
4	Tools.....	122
4.1	Assembly tools.....	122
4.2	Tools for disassembly.....	122

Type 3510 Micro-flow Valve

1	Information on Type 3510 Valve	123
1.1	Technical data	123
1.2	Note on replacing the trim	123
1.3	Parts	124
2	Tightening torques.....	125
2.1	Tightening torques to install the seat	125
2.2	Tightening torques for threaded bushing	125
2.3	Tightening torques for intermediate piece.....	125
2.4	Tightening torques for bottom slotted nut.....	125
2.5	Tightening torques for top slotted nut (ring nut).....	125

2.6	Tightening torques for hex nuts on the tip of the plug stem	125
2.7	Tightening torques for bellows	125
2.8	Tightening torques for bellows seal/insulating section on the body	126
3	Lubricant	127
3.1	Recommended lubricant	127
3.2	Lubricant sorted by parts	127
4	Tools	128
4.1	Tool sets	128

Actuators

Type 2780 Pneumatic Actuator

1	Information on Type 2780 Valve	129
1.1	Technical data	129
1.2	Note on actuators with preloaded springs	129
1.3	Parts	130
2	Tightening torques	131
3	Lubricant	131
4	Tools	131

Types 3271 and 3277 Pneumatic Actuators

1	Information on Type 3271 and Type 3277 Actuators	133
1.1	Technical data for Type 3271	133
1.2	Technical data for Type 3277	133
1.3	Note on actuators with preloaded springs	133
1.4	Parts	134
2	Tightening torques	135
2.1	Tightening torques for nuts to connect the top and bottom diaphragm cases	135
2.2	Tightening torques for nuts to connect the top and bottom diaphragm cases when the actuator springs are compressed 135	
2.3	Tightening torques for ring nut	135
2.4	Tightening torques for collar nut	136
2.5	Tightening torques for retaining nut	136
2.6	Tightening torques for nut on compressor	136
2.7	Tightening torques for hose clamp	136
2.8	Tightening torques for rod of anti-rotation fixture	137
2.9	Tightening torques for stem connector clamps	137
3	Lubricant	138
3.1	Recommended lubricant	138
3.2	Lubricant sorted by parts and versions	138
3.3	Sealant	139
4	Tools	139
4.1	Type 3271 and Type 3277, 60 to 120 cm ² actuator areas	139
4.2	Type 3271 and Type 3277, 175 cm ² actuator area	139
4.3	Type 3271 and Type 3277, 240 cm ² actuator area	140
4.4	Type 3271 and Type 3277, 350 and 355 cm ² actuator areas	140
4.5	Type 3271 and Type 3277, 700 and 750 cm ² actuator areas	141

4.6	Type 3271, 1000 cm ² actuator area.....	142
4.7	Type 3271, 1400 cm ² actuator area.....	143
4.8	Type 3271, 2800 and 2 x 2800 cm ² actuator areas.....	144

Types 3371 and 3372 Pneumatic Actuators

1	Information on Type 3371 and Type 3372 Actuators.....	145
1.1	Technical data for Type 3371.....	145
1.2	Technical data for Type 3372.....	145
1.3	Note on versions of Type 3372.....	145
1.4	Note on actuators with preloaded springs.....	146
1.5	Parts.....	146
2	Tightening torques.....	148
2.1	Tightening torques for nuts to connect the top and bottom diaphragm cases.....	148
2.2	Tightening torques for screws on rods.....	148
2.3	Tightening torques for collar nut.....	148
2.4	Tightening torques for stem connector clamps.....	148
3	Lubricant.....	149
3.1	Recommended lubricant.....	149
3.2	Lubricant sorted by parts and versions.....	149
4	Tools.....	150
4.1	Type 3371 and Type 3372, 120 cm ² actuator area.....	150
4.2	Type 3371 and Type 3372, 350 cm ² actuator area.....	150

Type 3275 Pneumatic Piston Actuator

1	Information on Type 3275 Valve.....	153
1.1	Technical data.....	153
1.2	Parts.....	154
2	Tightening torques.....	155
2.1	Tightening torques for tie rods.....	155
3	Lubricant.....	155
4	Tools.....	155

Type 3275A Pneumatic Piston Actuator

1	Information on Type 3275A.....	157
1.1	Technical data.....	157
1.2	Parts.....	158
2	Tightening torques.....	159
2.1	Tightening torques for tie rods.....	159
3	Lubricant.....	159
4	Tools.....	159

Type 3571 Pneumatic Actuator

1	Information on Type 3571 Valve.....	161
1.1	Technical data.....	161
1.2	Note on actuators with preloaded springs.....	161
1.3	Parts.....	161

2	Tightening torques.....	164
2.1	Tightening torques for nuts to connect the top and bottom diaphragm cases.....	164
2.2	Tightening torques for ring nut	164
2.3	Tightening torques for collar nut	164
2.4	Tightening torques for nut on compressor.....	164
2.5	Tightening torques for hose clamp	165
2.6	Tightening torques for stem connector clamps.....	165
3	Lubricant.....	166
3.1	Recommended lubricant	166
3.2	Lubricant sorted by parts and versions	166
4	Tools.....	167
4.1	Type 3571, 27 in ² or 175 cm ² actuator area.....	167
4.2	Type 3571, 54 in ² or 350 cm ² actuator area.....	167
4.3	Type 3571, 116 in ² or 750 cm ² actuator area.....	168



1 Contact data of SAMSON's After-sales Service

If you have any questions concerning this document or on how to handle SAMSON valves and tools correctly, you can contact us as follows:

- Send an e-mail to SAMSON's After-sales Service (aftersaleservice@samsongroup.com)
- Call the after-sales service at your nearest SAMSON subsidiary or office. All addresses are available at www.samsongroup.com.

2 Safety instructions and measures

⚠ WARNING

Damage to health after contact with hazardous substances.

Certain lubricants (e.g. 8150-4008) are classified as hazardous substances. These substances have a special label and a material safety data sheet (MSDS) issued by the manufacturer.

- Make sure that an MSDS is available for any hazardous substance used. If necessary, contact the manufacturer to obtain an MSDS.
- Inform operating personnel about the hazardous substances and their correct handling.







3 Special tools for tightening torques

Special tools are required to assemble and remove some parts. Use adjustable torque wrenches with a stop signal or that indicate the torque being applied to achieve the right tightening torques.

Valves in large valve sizes often require tightening torques that can only be achieved through additional torque multiplication by using a torque multiplier or hydraulic power tool.

3.1 Torque wrench



Torque wrenches are available from SAMSON.

Size/Nm	Tool	Connections		Material no.	Image
2 to 10 Nm	Torque wrench with scale	1/4"	■	9932-3811	
	1/4" extension			9932-3228	
	1/4" socket			9932-3302	
10 to 120 Nm	Torque wrench	1/2"	■	9932-3812	
60 to 320 Nm	Torque wrench	1/2"	■	9932-3814	
100 to 550 Nm	Torque wrench	3/4"	■	9932-2237	
5 to 60 Nm	Interchangeable head torque wrench	9x12 mm	□	9932-2269	
20 to 120 Nm	Interchangeable head torque wrench	14x18 mm	□	9932-2268	
60 to 320 Nm	Interchangeable head torque wrench	14x18 mm	□	9932-2238	

Special tools for tightening torques

3.2 Torque multiplier



Gear-driven wrenches are available from SAMSON.

Valve size	Tool	Connections	Material no.	Image	
Series 240: DN 32 to 150/ NPS 1¼ to 6 Series 250: Up to DN 100/NPS 4	Torque multiplier SX30: – Transmission ratio 1:12.5 – Max. 3000 Nm – Accessories Spare shear pin	Input	9932-3808		
		½"			<input type="checkbox"/>
		Output			
		1"			
Series 250: DN 125 and 150	Torque multiplier KWN8000 – Transmission ratio 1:40 – Max. 8000 Nm Torque multiplier BOLTMAX MX80 – Transmission ratio 1:49 – Max. 8000 Nm	Input	9932-3802		
		¾"			<input type="checkbox"/>
		Output			
			1½"		
		Spare shear pin for KWN8000 (labeled "140") Spare shear pin for BOLTMAX MX80 (labeled "11K")	–	9932-3222	–
	Additional support for torque multiplier KWN8000		9932-3809	–	

i Note

Both the torque multipliers KWN8000 and BOLTMAX MX80 have the same material number. However, they have different gear ratios and spare shear pins. Therefore, always check which torque multiplier you are using.



3.3 Adapter

Designation	Connections		Material no.	Image
	<input type="checkbox"/>	<input checked="" type="checkbox"/>		
Adapter	1	1½	9532-0001	
Adapter	¾	½	9532-0011	
Adapter	¾	1	9932-2236	
Adapter	½	1	9932-2506	
Adapter	1½	1	9932-2291	
Adapter	½	¾	9932-3237	

3.4 Pneumatic adapter

Designation	Connection	Material no.	Image
Pneumatic adapter (short)	G 1/8	1280-4015	
	G 1/4	1280-4017	
	G 3/8	1280-4019	
	G 1/2	1280-4021	
	G 3/4	1280-4023	
	G 1	1280-4025	
Pneumatic adapter (standard)	G 1/8	1280-4014	
	G 1/4	1280-4016	
	G 3/8	1280-4018 1280-4038	
	G 1/2	1280-4020	
	G 3/4	1280-4022 1280-4039	
	G 1	1280-4024	

3.5 Hydraulic power tool

Valve size		Tool	Material no.	Image
DN	NPS			
200 to 500	8 to 20	Hydraulic power tool	1280-1010	 

Width across flats

Components:

- Hydraulic pump with continuously adjustable output pressure (0 to 800 bar) and adapted output pressure gauge (scale in bar and Nm)
- Transport-proof, lockable hydraulic tank mounted in a frame
- Accessories

Special features:

- Power supply 230 V, 50/60 Hz
- Ratchet head capacity: 5000 Nm
- Maximum torque of torque wrench: 5000 Nm

4 Width across flats

DIN	
Thread	Width across flats (SW) in mm
M4	7
M5	8
M5 to 6	9
M6	10
M7	11
M8	13 (14)
M10	16 (17)
M12	18 (19)
M14	21 (22)
M16	24
M18	27
M20	30
M22	32 (34)
M24	36
M27	41
M30	46
M33	50
M36	55
M39	60
M42	65
M45	70
M48	75
M52	80
M56	85
M60	90

ANSI	
Thread	Width across flats (SW) in inches (hex nut)
1/4"-20UNC	7/16
5/8"-11UNC	5/16
3/4"-10UNC	1 1/8
7/8"-9UNC	1 5/16
1"-8UNC	1 1/2
1 1/8"-7UNC	1 11/16
1 1/4"-7UNC	1 7/8
1 3/8"-6UNC	2 3/16
1 1/2"-6UNC	2 1/4
Thread	Width across flats (SW) in inches (heavy hex nut)
1/4"-20UNC	1/2
5/16"-18UNC	9/16
3/8"-16UNC	11/16
7/16"-14UNC	3/4
1/2"-13UNC	7/8
9/16"-12UNC	5/16
5/8"-11UNC	1 1/16
3/4"-10UNC	1 1/4
7/8"-9UNC	1 7/16
1"-8UNC	1 5/8
1 1/8"-7UNC	1 9/16
1 1/4"-7UNC	2
1 3/8"-6UNC	2 3/16
1 1/2"-6UNC	2 3/8
1 5/8"-6UNC	2 9/16
1 3/4"-5UNC	2 3/4
2"-4.5UNC	3 1/8
2 1/4"-4,5UNC	3 1/2
2 1/2"-4UNC	3 7/8
2 3/4"-4UNC	4 1/4



1 Information on Series 240 Valves

1.1 Technical data

		Series 240
Valve size	DIN	DN 15 to 300
	ANSI	NPS ½ to 12
Pressure rating	DIN	Up to PN 40
	ANSI	Up to Class 300

1.2 Types of pressure balancing

SAMSON valves have different types of pressure balancing. The parts subject to wear and spare parts for the various types of pressure balancing are not interchangeable. Therefore, it is important to always specify or check the pressure balancing used when ordering spare parts, for repairs and after-sales inquiries. The configuration ID or the SAMSON order number (including position within the order) is necessary in this case.

1.3 Parts

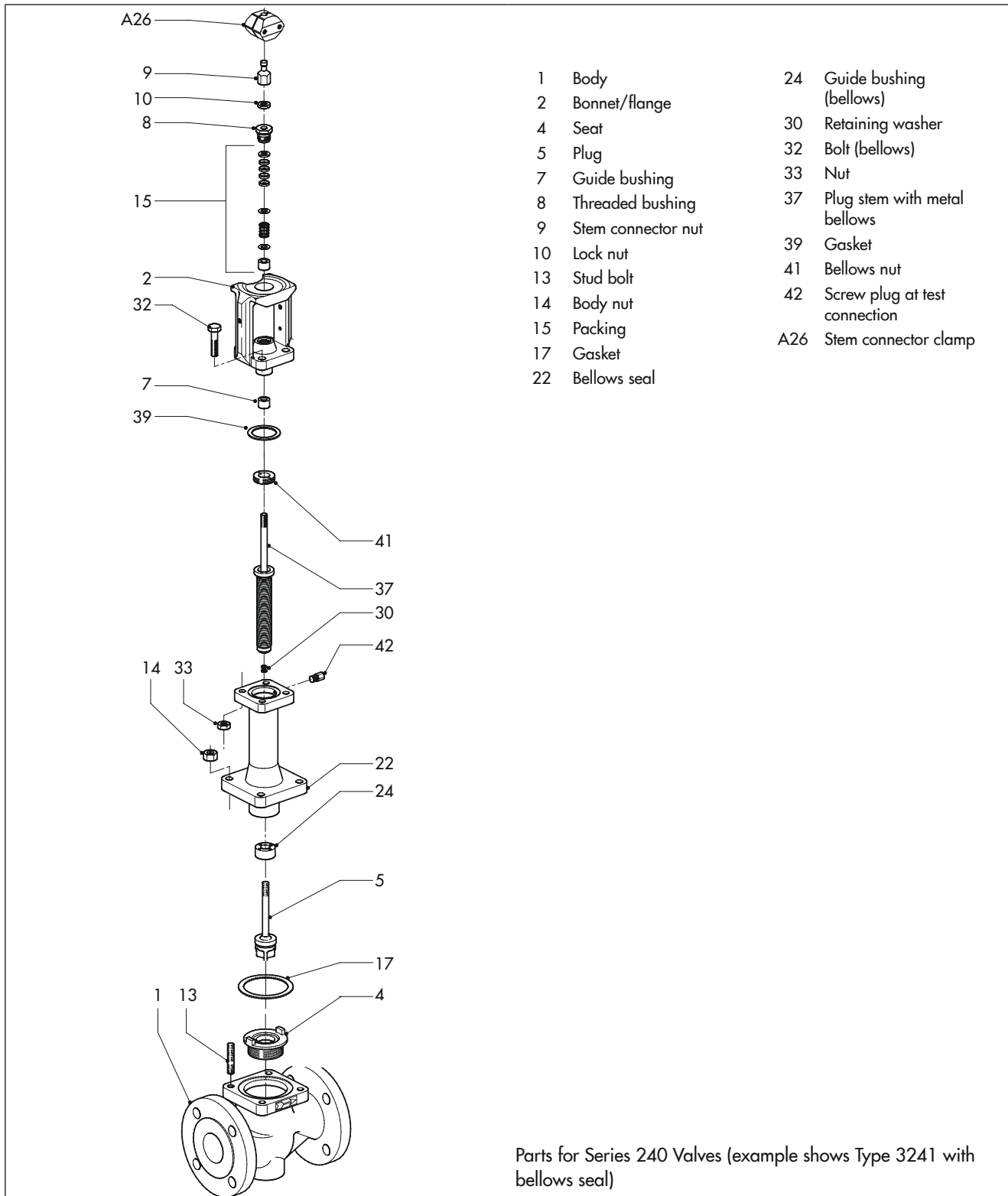

2 Tightening torques

Note concerning the following specifications

- All tightening torques specified in Nm
- Tightening torque tolerance: $\pm 10\%$
- The tightening torques are based on a friction coefficient of 0.06 with a lubricated seat thread and facing.
- After long operating times or long periods or use at temperatures above 250 °C, the breakaway torque may be twice as high as the tightening torque.
- Certain valves (e.g. Type 3248) have their own tightening torques. Refer to the documentation for specific valve models.

2.1 Tightening torques to install the seat

Tightening torques in Nm · Seat (4)

Valve size			Seats made of 1.4006, 1.4462 and 2.4610		Seats made of 2.4360, 2.4856, 2.4068 and 1.4876		Seats made of all other materials	
DN	NPS	Thread	Without torque multiplier	With torque multiplier ¹⁾	Without torque multiplier	With torque multiplier ¹⁾	Without torque multiplier	With torque multiplier ¹⁾
15 to 25	½ to 1	M32x1.5	170	– ²⁾	130	– ²⁾	160	– ²⁾
32 to 50	1½ to 2	M58x1.5	500	40	380	30	480	38
65 to 80	2½ to 3	M90x1.5	1050	84	800	64	900	72
100	4	M110x1.5	1550	124	1150	92	1250	100
125	5	M125x1.5	1750	140	1300	104	1400	112
150	6	M152x1.5	2600	208	2000	160	2300	184
DN	NPS	Thread	Without hydraulic power tool	With hydraulic power tool ³⁾	Without hydraulic power tool	With hydraulic power tool ³⁾	Without hydraulic power tool	With hydraulic power tool ³⁾
200	8	M230x3	5000	650	3750	490	4500	585
250	10	M285x3	7500	810	5650	610	6750	730
300	12	M350x4	13000	1210	9800	915	11700	1090



¹⁾ Torque multiplier with gear ratio 1:12.5

²⁾ Only use a torque wrench to tighten the seat; do not use an additional torque multiplier.

³⁾ The following multiplication factors apply when using the hydraulic power tool: DN 200: 7.7, DN 250: 9.25, DN 300: 10.75

Special tools

The following tools can be used to install and remove the seat:

Valve size		Tool	Material no.	Image
DN	NPS			
Up to 200	Up to 8	Torque multiplier SX30, gear ratio 1:12.5, max. 3000 Nm	9932-3808	
200 to 500	8 to 20	Hydraulic power tool	1280-1010	

Tightening torques

2.2 Tightening torques for connection of body and bonnet/flange

Valve size		Thread of stud bolt Body/bonnet	No. of bolts	Tightening torque for body nut (14) in Nm
DN	NPS			
15 to 25	½ to 1	M10/¾" – 16 UNC	4	30
32 to 50	1½ to 2	M12 / ½" – 13 UNC	4	50
65 to 80	2½ to 3	M16/¾" – 11 UNC	4	100
100	4	M20 / ¾" – 10 UNC	4	150
125	5	M16	8	120
150	6	M20/1" – 8 UNC	8	160
200	8	M27/1" – 8 UNC	8	230
250	10	M24 / 7/8" – 9 UNC	16	170
300	12	M27/1" – 8 UNC	16	250

2.3 Tightening torques for plug stem connection in versions with insulating section or bellows seal

Valve size		Tightening torque for plug/plug stem (5) in Nm
DN	NPS	
15 to 80	½ to 3	50
100 to 150	4 to 6	140

2.4 Tightening torques for screw plug at test connection

Valve size		Tightening torque for screw plug (42) in Nm
DN	NPS	
15 to 80	½ to 3	30
100 to 150	4 to 6	30

2.5 Tightening torques for nuts (bellows seal)

Valve size		Tightening torque for nut (bellows seal) (41) in Nm
DN	NPS	
15 to 80	½ to 3	160
100 to 150	4 to 6	200

2.6 Tightening torques for connection of bonnet/flange with insulating section or bellows seal

Valve size		Thread of bolt (32)	No. of bolts	Tightening torque for nut (33) in Nm
DN	NPS			
15 to 80	½ to 3	M10/¾" – 16 UNC	4	30
100 to 150	4 to 6	M20/1" – 8 UNC	4	160
200 to 300	8 to 12	M27/1" – 8 UNC	8	230

2.7 Tightening torques for threaded bushing

Valve size		Tightening torque for threaded bushing (8) [Nm]
DN	NPS	
15 to 80	½ to 3	50
100 to 150	4 to 6	80



2.8 Tightening torques for stem connector nut and lock nut

Valve size		Connecting thread of plug stem (5)	Tightening torque for stem connector nut (9) in Nm
DN	NPS		
15 to 80	½ to 3	M10x1	50
100 to 150	4 to 6	M16x1.5 ¹⁾	120
200 and larger	8 and larger	M36x1.5	300

¹⁾ For DN 125 and 150 only

Special tools

The following tools are required for the tightening torques:

Valve size		Tool	Material no.	Image
DN	NPS			
15 to 80	½ to 3	Torque wrench	9932-2269	
100 and larger	4 and larger	Torque wrench	9932-2238	
15 to 80	½ to 3	Crowfoot wrench	9932-2281	
100 to 150	4 to 6	Crowfoot wrench	9532-0012	
200 and larger	8 and larger	Crowfoot wrench	1280-3188	
15 to 80	½ to 3	Open-end wrench	9932-1217	
100 to 150	4 to 6	Open-end wrench	9932-1225	
200 and larger	8 and larger	Open-end wrench	9932-3110	



2.9 Tightening torques for stem connector clamps

The following tightening torques apply for connecting the actuator and plug stems:

Actuator area in cm ²	Connecting diameter in mm	Thread size	Tightening torque for stem connector clamps (A26) in Nm
80 to 240	10	M5	5
350 to 700	16	M6	9
1400	22	M12	75
2800	40	M16	145

Special tools

The following tools are required for the tightening torques:

Actuator area in cm ²	Tool	Material no.	Image
80 to 240 350 to 700	Torque wrench	9932-3812	
1400 2800	Torque wrench	9932-3814	
1400	Hex socket	9932-3324	
2800	Hex socket	9932-3328	

3 Lubricant

⚠ WARNING

Damage to health after contact with hazardous substances.

Certain lubricants (e.g. 8150-4008) are classified as hazardous substances. These substances have a special label and a material safety data sheet (MSDS) issued by the manufacturer.

→ Make sure that an MSDS is available for any hazardous substance used. If necessary, contact the manufacturer to obtain an MSDS.

→ Inform operating personnel about the hazardous substances and their correct handling.

3.1 Recommended lubricant

Application	Quantity [g]	Temperature range in °C	Color	Material no. of lubricant
Valves for oxygen service (free of oil and grease)	60	-60 to +250	White	8150-0116
Pneumatic devices (O-rings, guide bearings)	-	-40 to +260	White/transparent	8150-0100
Seat thread, stud bolts, spring compression	250	-180 to +1200	Gray	8150-4008
Plug stem seal	10	-200 to +220	White	8150-4000
	60			8150-4007
	650			8150-0073

3.2 Lubricant for adjustable packings

For valve materials EN-GJL-250 (EN-JL 1040), EN-GJS-400-18-LT (EN-JL 1049), 1.0619, 1.0402, 1.4571, 1.4581 and 1.4408

Packing form	Material no. of lubricant	Packing item number		
		DN 15 to 50 NPS ½ to 2	DN 65 to 80 NPS 2½ to 3	DN 100 to 150 NPS 4 to 6
A	8150-0111	1120-1078	1120-1100	1120-1079
B		1120-1080	1120-1101	1120-1081
C		1120-1082	1120-1102	1120-1083
W		1120-1090	1120-1103	1120-1091
H	Do not use any lubricant.	1120-1096	1120-1104	1120-1097
I		1120-1098	1120-1105	1120-1099

3.3 Lubricant sorted by parts and versions

Application	Seat	Stud bolt	Plug	Plug stem with metal bellows
Number within drawing (see section 1.3)	4	13	5	37
Series 240	8150-4008	8150-4008	8150-4000/ 8150-4007/ 8150-0073	8150-4008
Version for gas (DIN EN 161)	8150-4008	8150-4008	8150-4000/ 8150-4007/ 8150-0073	8150-4008
Version for oxygen service (cold box)	8150-0116	8150-0116	8150-0116	8150-0116
Application	Retaining washer	Bellows nut	Bolt (bellows seal)	Packing
Number within drawing (see section 1.3)	30	41	32	15
Series 240	8150-4000/ 8150-4007/ 8150-0073	8150-4008	8150-4008	8150-4000/ 8150-4007/ 8150-0073
Version for gas (DIN EN 161)	8150-4000/ 8150-4007/ 8150-0073	8150-4008	8150-4008	8150-4000/ 8150-4007/ 8150-0073
Version for oxygen service (cold box)	8150-0116	8150-0116	8150-0116	8150-0116

4 Tools



4.1 Pliers for assembly and disassembly

Plug stem diameter in mm	Tool	Material no.	Image
10 and 16	Pliers to hold parabolic plugs stationary	9129-1995	

4.2 Packing extractor

Valve size		Tool	Material no.	Image
DN	NPS			
15 to 40	½ to 1½	Packing extractor	1280-3037	
50 to 500	2 to 20	Packing extractor	1280-3035	
200 to 500	8 to 20	Packing extractor to pull out spacers out of the packing chamber	1280-3036	

4.3 Tool for high-temperature packings

Valve size		Tool	Material no.	Image
DN	NPS			
15 to 80	½ to 3	Tool (modified threaded bushing), 10 mm plug stem diameter	1280-2005	
100 to 150	4 to 6	Tool (modified threaded bushing), 16 mm plug stem diameter	1280-2006	
200 to 500	8 to 20	Tool (modified threaded bushing), 40 mm plug stem diameter	1280-2009	
15 to 80	½ to 3	Socket wrench with 24 width across flats (modified threaded bushing), 10 mm plug stem diameter	1280-2010	
100	4	Socket wrench with 30 width across flats (modified threaded bushing), 16 mm plug stem diameter, 700 cm² actuator area	1280-2011	
100 to 150	4 to 6	Socket wrench with 30 width across flats (modified threaded bushing), 10 mm plug stem diameter, 1400 cm² actuator area	1280-2012	



1 Information on Type 3241 Valve

1.1 Technical data

		Type 3241
Image		
Valve size	DIN	DN 15 to 300
	ANSI	NPS ½ to 12
Associated product documentation	Data sheet	▶ T 8015 (DIN) and ▶ T 8012 (ANSI)
	Mounting and operating instructions	▶ EB 8015 (DIN) and ▶ EB 8012 (ANSI)

1.2 Note on different seat wrenches for Type 3241 (DN 250/NPS 10)

Until July 2003, the same body was used for Type 3241 Valves and self-operated regulators in sizes DN 250/NPS 10, regardless of the body material used.

After July 2003, a new body was used for Type 3241 Valves in DN 250/NPS 10. As a result, a different seat wrench is required for the new body (see table). This does not apply to self-operated regulators, which still use the original bodies. Other seat/plug trims are used for the new body of Type 3241 Valves.

Information on Type 3241 Valve

		Body of Type 3241 · DN 250/NPS 10	
		Original body (until 2003)	New body (2003 onwards)
Dimensions	Seat thread	M230x3 (same seat thread as for DN 200/NPS 8)	M285x3 (standard seat thread for Series 250 Valves)
	Inside dimension from body facing to seat thread	221 mm	341 mm
External body marking (model number ¹⁾)		8294	8994 8995
Order number for seat wrench		1280-1000	1280-1101
Drawing		<p> $\text{Ø}260,0405 \pm 0,0405$ $(\text{Ø}260 \text{ H}8)$ $221 \pm 0,2$ </p>	<p> $\text{Ø}320,0445 \pm 0,0445$ $(\text{Ø}320 \text{ H}8)$ $341 \pm 0,2$ </p>
Drawing no.		0101-3588	0103-4113

¹⁾ The model number is located on the body in the last row of the inscription field together with body marking. The number is cast at the foundry.





1.3 Parts

Parts of the valve assembly are listed in the Parts section for Series 240 Valves.

2 Tools





2.1 Tools for standard version

2.1.1 Seat wrenches

Valve size		Pressure rating	Material no.	Image
DN	NPS			
15 to 25	1	–	0440-0065	
32 to 50	2	–	9110-2464	
65 to 80	3	–	9110-2467	
100	4	–	9110-2471	
125	5	–	9110-4075	
150	6	–	9110-4076	
200	8	10 to 40	1280-1000	
250	10	10 to 40	1280-1000/1280-1101 Read note in section 1.2.	
300	12	10 to 40	1280-1200	





Special tools

The following tools are additionally required to install and remove the seat:





Valve size		Tool	Material no.	Image
DN	NPS			
32 to 150	1¼ to 6	Torque multiplier SX30, gear ratio 1:12.5, max. 3000 Nm	9932-3808	
32 to 50	1¼ to 2	Torque wrench	9932-3812	
80 to 150	3 to 6	Torque wrench	9932-3814	
200 to 500	8 to 20	Hydraulic power tool	1280-1010	

Tools

2.1.2 Packing tools

Valve size		Tool	Material no.	Image
DN	NPS			
15 to 80	½ to 3	Mandrel (for adjustable packing)	1280-3061	
15 to 80	½ to 3	Caulking tool	1280-3062	
15 to 80	½ to 3	Caulking tool for guide bushing	1280-6144	
15 to 80	½ to 3	Mandrel	1280-3202	
100 to 150	4 to 6	Mandrel (for adjustable packing)	1280-3063	
100 to 150	4 to 6	Caulking tool	1280-3064	
15 to 80	½ to 3	Punch for guide bushing	1280-3081	
100 to 150	4 to 6	Punch for guide bushing	1280-3087	
50 to 500	2 to 20	Packing extractor	1280-3035	
200 to 500	8 to 20	Packing extractor to pull out spacers out of the packing chamber	1280-3036	
200 and larger	8 and larger	Packing tool (40 mm diameter)	1280-3041	
200 and larger	8 and larger	Hook wrench to loosen and tighten the packing nut	1280-3000	

2.2 Tools for version with insulating section or bellows seal

Valve size		Tool	Material no.	Image
DN	NPS			
15 to 80	½ to 3	Socket wrench for bellows/plug unit	1280-3018	
15 to 80	½ to 3	Wrench for bellows nut ¹⁾	1280-4002	
100 to 150	4 to 6	Socket wrench for bellows (width across flats 19)	1280-3019 ²⁾	
100 to 150	4 to 6	Wrench for bellows nut ¹⁾	1280-4005	
100 to 150	4 to 6	Socket wrench for bellows (width across flats 17)	1280-3097 ²⁾	

¹⁾ Wrenches for the bellows nut are only required for versions with bellows seal.



²⁾ The bellows used in Type 3241 Valves in DN 100 to 150/NPS 4 to 6 have been changed. The assembly wrench (material no. 1280-3019) is used for the old bellows/plug unit (material no. 1190-1838). The assembly wrench (material no. 1280-3097) is used for the new bellows/plug unit (material no. 1990-6885).

2.3 Tools for version with pressure balancing

Special wrench fittings and torque wrenches are required for Type 3241 Valves with pressure balancing with ring nut to install the ring nut. No special tools are required for valve versions with clamping rings.





i Note

Contact SAMSON's After-sales Service to find out which version is used in the valve (ring nut or clamping ring).

Valve size		Seat bore	Wrench fitting		Ring nut	Torque wrench	
DN	NPS		Material no.	Image	Material no.	Material no.	Image
80	3	80	1280-6043		0250-1702	9932-2268	
100	4						
125	5						
150	6						
200	8	150	1280-6045		0250-1791	9932-2268	
250	10						
300	12						



2.4 Tools for PSA valves

Special mandrels are required to install guide bushings and wiper rings in PSA valves (Type 3241, Type 3243 and Type 3244):

Valve size		Tool	Material no.	Image
DN	NPS			
15 to 80	½ to 3	Mandrel to install guide bushings	1280-3025	
100 to 150	4 to 6		1280-3022	
15 to 80	½ to 3	Mandrel to install wiper rings	1280-3023	
100 to 150	4 to 6		1280-3020	





2.5 Tools for valves with AC trims

Seat wrenches for AC-1 and AC-2 trims



Valve size		Material no.	Image
DN	NPS		
50	2	9110-2464	
80	3	9110-2467	
100	4	9110-2471	
150	6	9110-4076	
200	8	1280-1005	
250	10	1280-1101	
300	12	1280-1200	

Special tools

The following tools are additionally required to install and remove the seat:

Valve size		Tool	Material no.	Image
DN	NPS			
32 to 150	1¼ to 6	Torque multiplier SX30, gear ratio 1:12.5, max. 3000 Nm	9932-3808	
32 to 50	1¼ to 2	Torque wrench	9932-3812	
80 to 150	3 to 6	Torque wrench	9932-3814	
200 to 500	8 to 20	Hydraulic power tool	1280-1010	

2.6 Lifting equipment

Valve size		Tool	Material no.	Image
DN	NPS			
200 and larger	8 and larger	Ring nut for plug stem with \varnothing 40 mm with M36x1.5 connecting thread	1280-3093	
200 and larger	8 and larger	Sling (2500 kg working load limit)	1280-3034	

1 Information on Type 3244 Valve

1.1 Technical data

		Type 3244
Image		
Valve size	DIN	DN 15 to 150
	ANSI	NPS ½ to 6
Style		Three-way valve (mixing or diverting valve)
Associated product documentation	Data sheet	▶ T 8026
	Mounting and operating instructions	▶ EB 8026

1.2 Parts

Parts of the valve assembly are listed in the Parts section for Series 240 Valves.

2 Tightening torques

2.1 Tightening torques for screws to mount the plug in diverting valves

Valve size		Seat bore (Ø) in mm	Thread type	Tightening torque for bolt in Nm
DN	NPS			
32 to 50	1½ to 2	31	M8	20
40 to 50	1½ to 2	38	M6	12
50 to 80	2 to 3	48	M6	12
65 to 80	2½ to 3	63	M8	20
100	4	80	M8	25
125	–	90	M10	35
150	6	100	M10	40

2.2 Other tightening torques

Further tightening torques are listed in the section on tightening torques for Series 240 Valves.

3 Tools



3.1 Tools for standard version

3.1.1 Seat wrenches



Valve size		Material no.	Image
DN	NPS		
15 to 25	1	1280-0112	
32 to 50	2	1280-0209	
65 to 80	3	1280-0305	
100	4	1280-0405	
125	5	1280-0505	
150	6	1280-0605	

Special tools





The following tools are additionally required to install and remove the seat:

Valve size		Tool	Material no.	Image
DN	NPS			
32 to 150	1¼ to 6	Torque multiplier SX30, gear ratio 1:12.5, max. 3000 Nm	9932-3808	
32 to 50	1¼ to 2	Torque wrench	9932-3812	
80 to 150	3 to 6	Torque wrench	9932-3814	

3.1.2 Packing tools

Valve size		Tool	Material no.	Image
DN	NPS			
15 to 80	½ to 3	Mandrel (for adjustable packing)	1280-3061	
15 to 80	½ to 3	Caulking tool	1280-3062	
100 to 150	4 to 6	Mandrel (for adjustable packing)	1280-3063	
100 to 150	4 to 6	Caulking tool	1280-3064	
15 to 80	½ to 3	Punch for guide bushing	1280-3081	
100 to 150	4 to 6	Punch for guide bushing	1280-3087	

3.2 Tools for version with insulating section or bellows seal

Valve size		Tool	Material no.	Image
DN	NPS			
15 to 80	½ to 3	Socket wrench for bellows/plug unit	1280-3018	
15 to 80	½ to 3	Wrench for bellows nut ¹⁾	1280-4002	
100 to 150	4 to 6	Socket wrench for bellows (width across flats 19)	1280-3019 ²⁾	
100 to 150	4 to 6	Wrench for bellows nut ¹⁾	1280-4005	
100 to 150	4 to 6	Socket wrench for bellows (width across flats 17)	1280-3097 ²⁾	

¹⁾ Wrenches for the bellows nut are only required for versions with bellows seal.





²⁾ The bellows used in Type 3244 Valves in DN 100 to 150/NPS 4 to 6 have been changed. The assembly wrench (material no. 1280-3019) is used for the old bellows/plug unit (material no. 1190-1838). The assembly wrench (material no. 1280-3097) is used for the new bellows/plug unit (material no. 1990-6885).

3.3 Tools for mixing valves with insulating section or bellows seal

Valve size		Tool	Material no.	Image
DN	NPS			
15 to 50	½ to 2	Tool to install bellows	1280-4003	
65 to 150	2½ to 6			

3.4 Tools for PSA valves

Special mandrels are required to install guide bushings and wiper rings in PSA valves (Type 3241, Type 3243 and Type 3244):

Valve size		Tool	Material no.	Image
DN	NPS			
15 to 80	½ to 3	Mandrel to install guide bushings	1280-3025	
100 to 150	4 to 6		1280-3022	
15 to 80	½ to 3	Mandrel to install wiper rings	1280-3023	
100 to 150	4 to 6		1280-3020	



1 Information on Type 3248 and Type 3246 Valves

1.1 Technical data for Type 3248

		Type 3248
Image		
Valve size	DIN	DN 15 to 150 ¹⁾
	ANSI	NPS ½ to 6
Style		Globe or angle valve Top-entry design
Associated product documentation	Data sheet	<ul style="list-style-type: none"> ▶ T 8093 ▶ T 8093-1
	Mounting and operating instructions	▶ EB 8093
	Spare parts list	▶ EL 8093

¹⁾ Additional versions: cryogenic valve as micro-flow version in DN 10 (Linde), aluminum angle-style valve body in DN 200 (Linde, Messer) · Tools only on request

1.2 Note on special versions of Type 3248

i Note

The Type 3248 Valve is available in various special versions that differ from the standard version, e.g. in valve size, pressure rating and materials used. These special versions were originally manufactured according to the customer specifications. As a result, the special versions are listed along with the name of the customer in this document, even in cases where these originally special versions have become standard.

1.3 Technical data for Type 3246

		Type 3246
Image		
Valve size	DIN	DN 15 to 300
	ANSI	NPS ½ to 12
Style		Globe or three-way valve (mixing valve) Non-top-entry design
Associated product documentation	Data sheet	▶ T 8046-1 ▶ T 8046-2 ▶ T 8046-3
	Mounting and operating instructions	▶ EB 8046
	Spare parts list	▶ EL 8046

1.4 Note on versions of Type 3246

i Note

The Type 3246 is based on the Type 3241, Type 3251 or Type 3244 Valve, depending on the valve style and pressure rating. The required tools vary accordingly. Therefore, it is important to always specify or check the version used when ordering spare parts, for repairs and after-sales inquiries. The configuration ID or the SAMSON order number (including position within the order) is necessary in this case.

Design of Type 3246

All versions of the Type 3246 Valve contain the following components:

- Long insulating section
- Circulation inhibitor, consisting of:
 - White PTFE-silk cords from adjustable packing
 - Threaded bushing 2.4360 (Monel) or 2.0402 (brass)
 - Grub screw (hex socket) to secure the threaded bushing
 - Packing spring or brass sleeve (the latter requires more packing rings)

A top-entry design is not used for these valves.

Since September 2007, the overall heights have changed and various cover plates for air separation units (ASU) and hydrogen/carbon monoxide (HyCO) plants are available for Type 3246 Valves.

Documentation and tools for Type 3246

Type 3246 – Version	Based on valve	Associated documentation	Associated tools, tightening torques and lubricant
Globe valve, Class 150 to 300	Type 3241 Valve with welding ends	▶ EB 8046 ▶ T 8046-1	▶ AB 0100, Type 3241 ▶ AB 0100, Series 240
Globe valve, Class 600 to 900	Type 3251 Valve with welding ends	▶ EB 8046 ▶ T 8046-2	▶ AB 0100, Type 3251 ▶ AB 0100, Series 250
Three-way valve, Class 150 to 300	Type 3244 Valve with flanges	▶ EB 8046 ▶ T 8046-3	▶ AB 0100, Type 3244 ▶ AB 0100, Series 240

Spare parts for Type 3246

Spare parts for Type 3246 differing from those required for Types 3241, 3244 and 3251 Valves (basis version):

Type 3246 – Spare parts					
Valve size		Pressure rating		Plug	Packing
DN	NPS	PN	Class		
15 to 50	½ to 2	16 to 40	150 to 300	Plug of Type 3241 for DN 65 to 80/NPS 2½ to 3; longer plug stem (135 mm)	Packing of Type 3241 for Class 150 to 300
15 to 40	½ to 1½	100 to 160	600 to 900	Plug with 16 mm plug stem diameter	Packing depending on plug stem diameter same as Series 250 (assignment of valve sizes differs)
50 to 100	2 to 4	100 to 160	600 to 900	Plug with 25 mm plug stem diameter	Packing depending on plug stem diameter same as Series 250 (assignment of valve sizes differs)
150	6	100 to 160	600 to 900	Plug with 40 mm plug stem diameter	Packing depending on plug stem diameter same as Series 250 (assignment of valve sizes differs)

1.5 Note on the use in air separation units (Type 3246 and Type 3248)

⚠ WARNING

Risk of injury due to incorrect handling of oxygen.

Type 3248 and Type 3246 Valves are frequently installed in air separation units used to produce oxygen. Precautions must be taken to prevent a possible fast reaction of oxygen, which can lead to combustion and explosions.

➔ Maintenance staff must attend a training at SAMSON lasting several days before they are allowed to perform any maintenance work on valves installed in air separation plants.

1.6 Parts

Parts of the assembly of a Type 3248 Valve are shown on the next page as an example.

Parts of the assembly of Series 240 or 250 Valves apply to the Type 3246 Valve depending on the version (see section 1.4).

Legend for the exploded diagrams on the next pages

1	Body	15	Packing	37	Plug stem with metal bellows
2	Bonnet/flange	17	Body gasket	39	Gasket
3	Yoke	22	Bellows seal	41	Bellows nut
4	Seat	24	Guide bushing (bellows)	42	Screw plug at test connection
5	Plug	27	Flange	71	Spacer stem
7	Guide bushing	28	Clamping ring	92	Castellated nut
8	Threaded bushing (packing nut)	30	Retaining washer		
9	Stem connector nut	32	Bolt (bellows)		
10	Lock nut	33	Nut		
13	Stud bolt	34	Screw		
14	Body nut	35	Lock nut for guide bushing (24)		

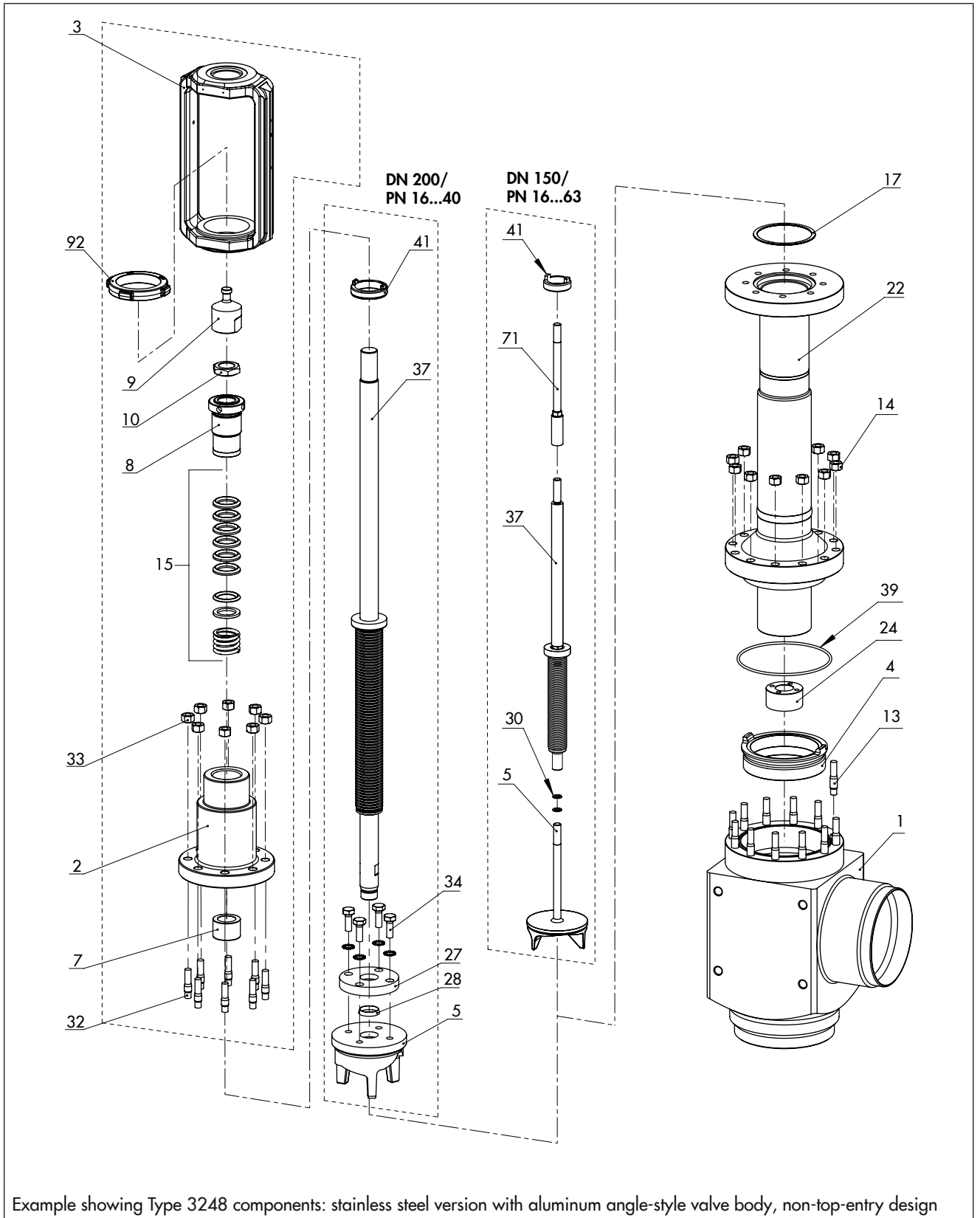

2 Tightening torques

2.1 Tightening torques for Type 3248 (DN 15 to 150/NPS ½ to 6)

Drawing no.: 1010-3928

i Note

See section 2.3 for tightening torques for versions with aluminum angle valve.

2.1.1 Tightening torques to install the seat

Tightening torques in Nm · Seat (4)

Valve size		Seats made of 1.4404		Seats made of 2.4610, 2.4819, 2.4375		Aluminum valve body	
DN	NPS	Torque multiplier					
		Without	With ¹⁾	Without	With ¹⁾	Without	With ¹⁾
15 to 25	½ to 1	160	– ²⁾	170	– ²⁾	100	– ²⁾
40 to 50	1½ to 2	540	27	560	28	300	15
65 to 80	2½ to 3	1020	51	1200	60	600	30
100	4	1420	71	1780	89	1000	50
150	6	2620	131	2980	149	1560	78

¹⁾ Total gear ratio 1:20 with torque multiplier (1990-5139) and gear (1990-5125), included in the basic tool kit (1280-3047)

²⁾ Only use a torque wrench to tighten the seat; do not use an additional torque multiplier.

2.1.2 Tightening torques for nuts on body and bellows seal

(only for version with aluminum valve body)

Valve size		Tightening torque for body nut (14) in Nm
DN	NPS	
15 to 25	½ to 1	30
40 to 50	1½ to 2	40
65 to 80	2½ to 3	60
100	4	100
150	6	120

2.1.3 Tightening torques for bolts on flange

Valve size		Tightening torque for bolt (34) on flange (27) in Nm
DN	NPS	
15 to 150	½ to 6	8

2.1.4 Tightening torques for plug stem connection

Valve size		Tightening torque for plug/plug stem (5) in Nm
DN	NPS	
15 to 80	½ to 3	50
100 to 150	4 to 6	140

2.1.5 Tightening torques for spacer stem

Valve size		Tightening torque for spacer stem (71) in Nm
DN	NPS	
15 to 80	½ to 3	30
100 to 150	4 to 6	40

2.1.6 Tightening torques for nuts on guide bushing (bellows)

Thread	Tightening torque for nut (35) on guide bushing (24) in Nm
M16x1.5	65
M22x1.5	150
M24x1.5	160
M35x1.5	200

2.1.7 Tightening torques for screw plug at test connection

Valve size		Tightening torque for screw plug (42) in Nm
DN	NPS	
15 to 150	½ to 6	25

2.1.8 Tightening torques for nuts (bellows seal)

Valve size		Pressure rating		Tightening torque for nut (bellows seal) (41) in Nm	
DN	NPS	PN	Class	Without torque multiplier	With torque multiplier ¹⁾
15 to 25	½ to 1	16 to 40	150 to 300	200	– ²⁾
		63 to 100	600	200	– ²⁾
40 to 50	1½ to 2	16 to 40	150 to 300	1140	57
		63 to 100	600	1140	57
65 to 80	2½ to 3	16 to 40	150 to 300	2980	149
		63 to 100	600	2980	149
100	4	16 to 40	150 to 300	3660	183
		63 to 100	600	5000	250
150	6	16 to 40	150 to 300	4380	219
		63 to 100	600	5000	250

¹⁾ Total gear ratio 1:20 with torque multiplier (1990-5139) and gear (1990-5125), included in the basic tool kit (1280-3047)

²⁾ Only use a torque wrench to tighten the bellows nut; do not use an additional torque multiplier.

2.1.9 Tightening torques for nuts on bellows seal and bonnet/flange

Valve size		Pressure rating		Tightening torque for nut (33) in Nm
DN	NPS	PN	Class	
15 to 25	½ to 1	16 to 40	150 to 300	40
		63 to 100	600	50
40 to 50	1½ to 2	16 to 40	150 to 300	80
		63 to 100	600	80
65 to 80	2½ to 3	16 to 40	150 to 300	150
		63 to 100	600	110
100	4	16 to 40	150 to 300	130
		63 to 100	600	150

Tightening torques

150	6	16 to 40	150 to 300	130
		63 to 100	600	190

2.1.10 Tightening torques for threaded bushing

Valve size		Pressure rating		Tightening torque for threaded bushing (8) [Nm]
DN	NPS	PN	Class	
15 to 25	½ to 1	16 to 40	150 to 300	50
		63 to 100	600	60
40 to 50	1½ to 2	16 to 40	150 to 300	50
		63 to 100	600	80
65 to 80	2½ to 3	16 to 40	150 to 300	80
		63 to 100	600	80
100	4	16 to 40	150 to 300	80
		63 to 100	600	80
150	6	16 to 40	150 to 300	80
		63 to 100	600	220

2.1.11 Tightening torques for stem connector nut and lock nut

Valve size		Pressure rating		Tightening torque for stem connector nut (9) and lock nut (10) in Nm
DN	NPS	PN	Class	
15 to 25	½ to 1	16 to 40	150 to 300	50
		63 to 100	600	70
40 to 50	1½ to 2	16 to 40	150 to 300	50
		63 to 100	600	120
65 to 80	2½ to 3	16 to 40	150 to 300	120
		63 to 100	600	120
100	4	16 to 40	150 to 300	120
		63 to 100	600	120
150	6	16 to 40	150 to 300	120
		63 to 100	600	160

2.2 Tightening torques for Type 3248 (DN 10/NPS ½, micro-flow valve)

Special version for Linde as micro-flow valve for temperatures down to -270 °C and Air Liquide for temperatures down to -196 °C

Drawing no.: 1040-0323

Component	Number within drawing (see section 1.6)	Tightening torque in Nm
Seat	4	20
Nuts for pillars	14	30
Spacer stem	71	20
Bellows nut	41	120
Test connection	42	25
Lock nut	10	8

2.3 Tightening torques for Type 3248 in DN 25 to 150, aluminum angle valve (Linde version)

The tightening torques are based on aluminum angle valves in DN 25 to 150 and PN 16 to 63 (Linde specification, drawing no. 1010-4200).

2.3.1 Tightening torques to install the seat

Valve size DN	Tightening torque for seat (4) in Nm	
	Without torque multiplier	With torque multiplier ¹⁾
25	100	– ²⁾
40 to 50	300	15
80	600	30
100	1000	50
150	1560	78

¹⁾ Total gear ratio 1:20 with torque multiplier (1990-5139) and gear (1990-5125), included in the basic tool kit (1280-3047)

²⁾ Only use a torque wrench to tighten the seat; do not use an additional torque multiplier.

2.3.2 Tightening torques for nuts on body and bellows seal

Valve size DN	Tightening torque for body nut (14) in Nm
25	30
40 to 50	70
80	70
100	150
150	170

2.3.3 Tightening torques for plug stem connection

Valve size DN	Tightening torque for plug/plug stem (5) in Nm
25 to 80	50
100 to 150	140

2.3.4 Tightening torques for spacer stem

Valve size DN	Tightening torque for spacer stem (71) in Nm
25 to 80	30
100 to 150	40

2.3.5 Tightening torques for nuts on guide bushing

Valve size DN	Tightening torque for nuts (35) on guide bushing (24) in Nm
25 to 80	65
100 to 150	150

Tightening torques

2.3.6 Tightening torques for screw plug at test connection

Valve size DN	Tightening torque for screw plug (42) in Nm
25 to 150	25

2.3.7 Tightening torques for nuts (bellows seal)

Valve size DN	Tightening torque for nut (bellows seal) (41) in Nm	
	Without torque multiplier	With torque multiplier ¹⁾
25	200	– ²⁾
40 to 50	1140	57
80	2300	115
100	3660	183
150	920	46

¹⁾ Total gear ratio 1:20 with torque multiplier (1990-5139) and gear (1990-5125), included in the basic tool kit (1280-3047)

²⁾ Only use a torque wrench to tighten the bellows nut; do not use an additional torque multiplier.

2.3.8 Tightening torques for nuts on bellows seal and bonnet/flange

Valve size DN	Tightening torque for nut (33) in Nm
25	30
40 to 150	70

2.3.9 Tightening torques for threaded bushing

Valve size DN	Tightening torque for threaded bushing (8) [Nm]
25	60
40 to 150	80



2.3.10 Tightening torques for stem connector nut and lock nut

Valve size DN	Tightening torque for stem connector nut (9) and lock nut (10) in Nm
25	70
40 to 150	120

3 Tools

3.1 Tool sets

Extensive sets of tools are available for Type 3248 Valves:

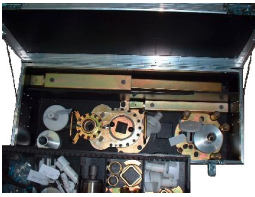
Valve size		Tool	Material no.	Image
DN	NPS			
10 to 15	½	Set of tools for micro-flow version ¹⁾	1280-3189	
15 to 25	½ to 1	Tool kit	1280-3073	
15 to 150	1 to 6	Basic tool kit	1280-3047	

¹⁾ For example, for helium liquefaction at Linde Kryotechnik AG, Switzerland

i Note

Due to continuous development of the Type 3248 Valve and the numerous special versions that are available, further tools are required in addition to the basic tool kit (1280-3047). These tools are not part of the basic tool kit and must be ordered separately.

i Note

The basic tool kit (1280-3047) includes a torque multiplier for tightening using the gear (1990-5125). This torque multiplier is currently listed under the material number 1990-5139 and has a gear ratio of 1:20 (as of 2015). Earlier versions of the basic tool kit included a torque multiplier listed under material number 1990-5126, which had a gear ratio of 1:18.5. Before assembly, check which torque multiplier you are using and which gear ratio applies as a result.

3.2 Extensions

An extension may be required to mount or remove the seat of the Type 3248 Valve depending on the version. The use of an extension depends on the following factors:

- Valve size
- Pressure rating
- Globe or angle valve
- Material (aluminum or stainless steel)
- Dimension H5 from the seat facing in the body to the top of the flange (see ‚Dimensional drawings‘)

Dimensional drawings

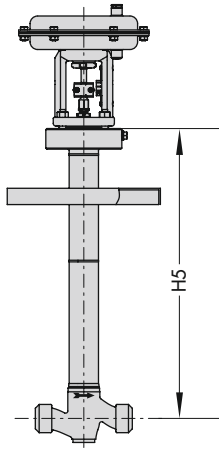

Globe valve with stainless steel body

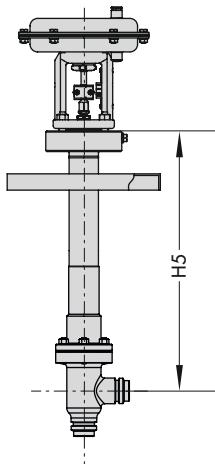

Angle valve with aluminum body

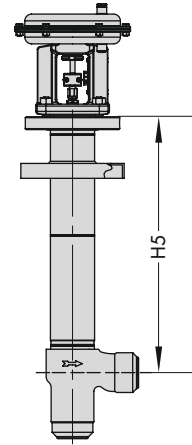

Angle valve with stainless steel body

3.2.1 Extensions for the standard version

Valve sizes DN 15 to 150 (NPS 1/2 to 6), pressure rating PN 16 to 100 (Class 150 to 600), versions with globe valve, angle valves with aluminum body or angle valves with stainless steel body, version for Air Products (HyCO)

Valve size		Material number for tool kit	Extension	Material number for extension	Image
DN	NPS				
15 to 25	1/2 to 1	1280-3047	Without extension	-	-
32 to 50	1 1/4 to 2	1280-3047	Extension for H5 higher than 665 mm	1280-3054	
65 to 80	2 1/2 to 3	1280-3047	Extension for H5 higher than 665 mm	1280-3055	
100	4	1280-3047	Extension for H5 higher than 840 mm ¹⁾	1280-3055	
150	6	1280-3047	Extension for H5 higher than 840 mm	1280-3055	



¹⁾ A supporting flange (material no. 1890-8370) is additionally required for PN 63 to 100

3.2.2 Extensions for Linde version

Version as angle valve with aluminum body

Valve size DN	Material number for tool kit	Extension	Material number for extension	Image
25	1280-3047	Without extension	-	-
40 to 80	1280-3047	With extension	1280-3054	See Table 'Extensions for the standard version'
100	1280-3047	With extension	1280-3055	
150	1280-3047	Without extension	-	-

3.3 Further tools for standard version

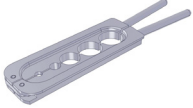



Valve size		Tool	Material no.	Image
DN	NPS			
100	4	Supporting flange for PN 63 to 100/ Class 600	1890-8370	
15 to 150	½ to 6	Anti-rotation fixture for split plug stem (with 17 and 24 mm socket wrench); only required for disassembly of bellows without anti-rotation fixture (year of manufacture 2000)	1280-3031	
15 to 150	½ to 6	Pliers for assembly and disassembly of parabolic plugs with 10 mm plug stem diameter	1280-3192	

Special tools

The following tools are additionally required for installation or removal:

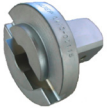
Valve size		Tool	Material no.	Image
DN	NPS			
150	6	Torque wrench	9932-3814	

3.4 Further tools for Linde and Messer versions

Valve size DN	Tool	Material no.	Image
80	Special socket for bellows nut	0440-0211	
100	Supporting flange	1890-8370	
150	Tool (Linde) for non-top-entry version, including: Supporting flange/adaptor plate Special socket for bellows nut	1280-0616 1890-8369 0440-0192	
150	Special socket for bellows nut (individual part)	0440-0278	

Tools

Special tools

The following tools are additionally required for installation or removal:

Valve size DN	Tool	Material no.	Image
150	Torque wrench	9932-3814	

3.5 Additional clamping elements

The additional clamping elements are required for AC-trims with special seat bores.

Seat bore	Tool	Material no.	Image
16 mm	Clamping element	0320-2473	
18 mm	Clamping element	0320-2477	
22 mm	Clamping element	0320-2478	
50 mm	Clamping element	0320-2479	

1 Information on Type 3249 Valve

1.1 Technical data

		Type 3249
Image		
Valve size (standard)	DIN	DN 15 to 100
	ANSI	NPS ½ to 4
Associated product documentation	Data sheet	▶ T 8048
	Mounting and operating instructions	▶ EB 8048

1.2 Note on Type 3249

The Type 3249 Angle Valve is designed for aseptic applications in the food and pharmaceutical industries according to DIN or ANSI standards. Special standards and regulators apply in these industries, which are essential for the correct and safe handling of products. Contact SAMSON's After-sales Service department if you have any questions.

1.3 Note on actuators

The Type 3249 Angle Valve can be combined with the Type 3271 and Type 3277 Pneumatic Actuators.

- Tightening torques, lubricants and tools for the Type 3271 and Type 3277 Pneumatic Actuators are listed in the section on Type 3271 and Type 3277 Actuators in this document.

1.4 Parts

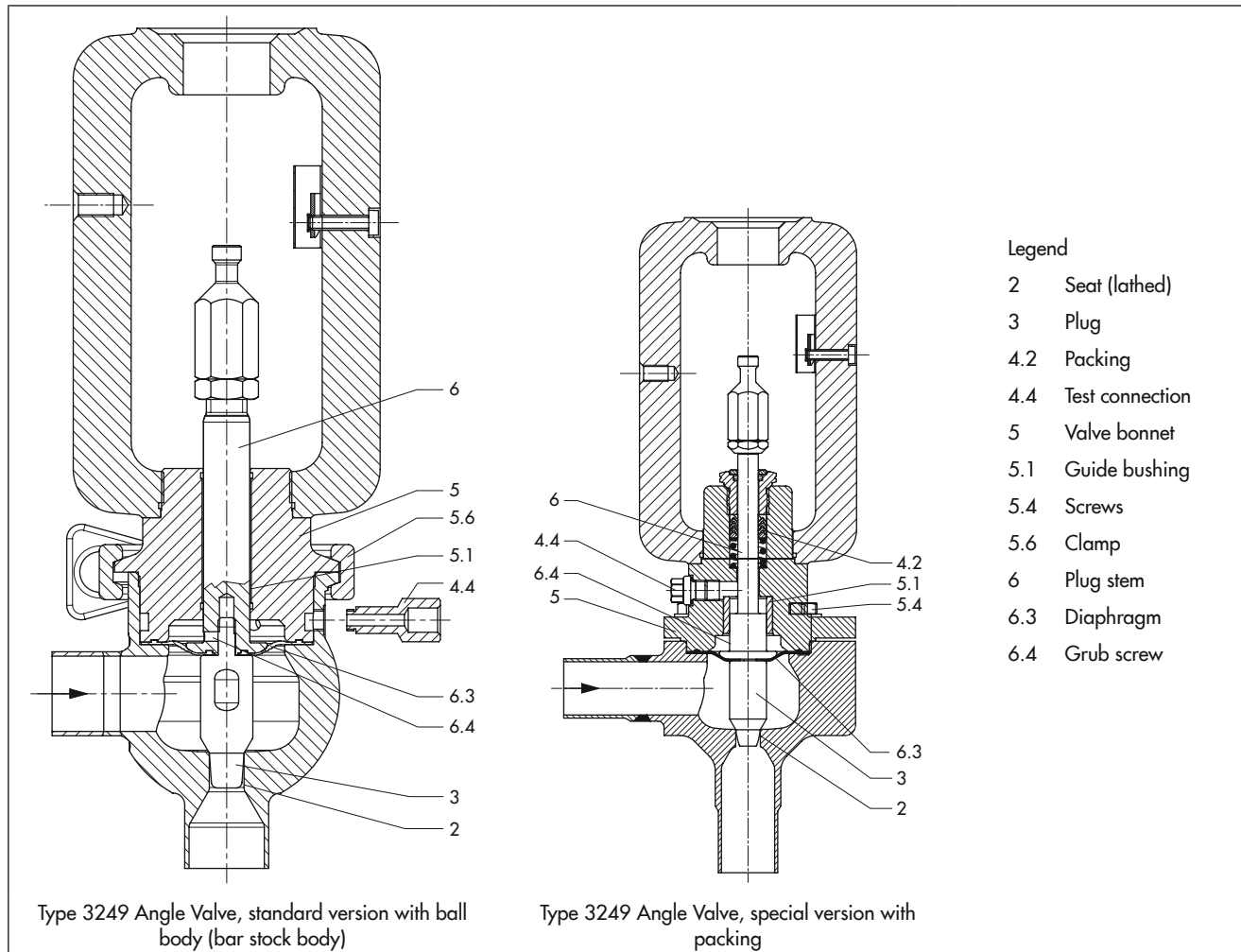

2 Tightening torques

2.1 Tightening torques for Type 3249 with Type 3271 or Type 3277 Actuator

i Note

Tightening torques for the Type 3271 and Type 3277 Pneumatic Actuators are listed in the section on Type 3271 and Type 3277 Actuators in this document.

2.1.1 Tightening torques for connection of plug and plug stem

Valve size		Tightening torque for plug (3) and plug stem (6) in Nm
DN	NPS	
15 to 25	½ to 1	10
32 to 100	1¼ to 4	70

2.1.2 Tightening torques for connection of body and valve bonnet (special version)

Valve size		Tightening torque for bolt in Nm
DN	NPS	
15 to 25	½ to 1	16
32 to 65	1¼ to 2½	40
80 and 100	3 and 4	135

2.1.3 Tightening torques for connection of actuator stem and plug stem

Valve size		Tightening torque for actuator stem and plug stem in Nm
DN	NPS	
15 to 50	½ to 2	4

3 Lubricant

⚠ WARNING

Damage to health after contact with hazardous substances.

Certain lubricants (e.g. 8150-4008) are classified as hazardous substances. These substances have a special label and a material safety data sheet (MSDS) issued by the manufacturer.

→ Make sure that an MSDS is available for any hazardous substance used. If necessary, contact the manufacturer to obtain an MSDS.

→ Inform operating personnel about the hazardous substances and their correct handling.

3.1 Recommended lubricant

Application	Temperature range in °C	Color	Material no. of lubricant
Valves for food processing	-50 to +150	White	8150-9002

3.2 Lubricant sorted by parts and versions

Application	Plug, thread	Plug stem, thread	Grub screw	Guide bushing
Number within drawing (see section 1.4)	3	6	6.4	5.1
Material no. of lubricant	8150-9002	8150-9002	8150-9002	8150-9002
Application	Packing	Flange/valve bonnet	Screw, thread	
Number within drawing (see section 1.4)	4.2	5	5.4	
Material no. of lubricant	8150-9002	8150-9002	8150-9002	

4 Tools

Valve size		Tool	Connections		Material no.	Image
DN	NPS					
15 to 25	½ to 1	Set of tools consisting of clamping rings to clamp the plug stem in a vise	-	-	1281-0035	
32 to 50	1¼ to 2					



1 Information on Series 250 and 280 Valves

1.1 Technical data of Series 250 Valves

		Series 250 Globe valves, three-way valves and angle valves
Valve size	DIN	DN 15 to 500
	ANSI	NPS ½ to 24
Pressure rating	DIN	Up to PN 400
	ANSI	Up to Class 2500

1.2 Technical data of Series 280 Valves

		Series 280 Steam conditioning valves
Valve size	DIN	DN 50 to 500
	ANSI	NPS 2 to 20
Pressure rating	DIN	Up to PN 160
	ANSI	Up to Class 900

1.3 Types of pressure balancing

SAMSON valves have different types of pressure balancing. The parts subject to wear and spare parts for the various types of pressure balancing are not interchangeable. Therefore, it is important to always specify or check the pressure balancing used when ordering spare parts, for repairs and after-sales inquiries. The configuration ID or the SAMSON order number (including position within the order) is necessary in this case.

1.4 Note on specifications

The construction of Series 280 Steam Conditioning Valves is based on that of Series 250 Valves. Therefore, the specifications apply to both Series 250 and Series 280, if not explicitly specified.

1.5 Parts

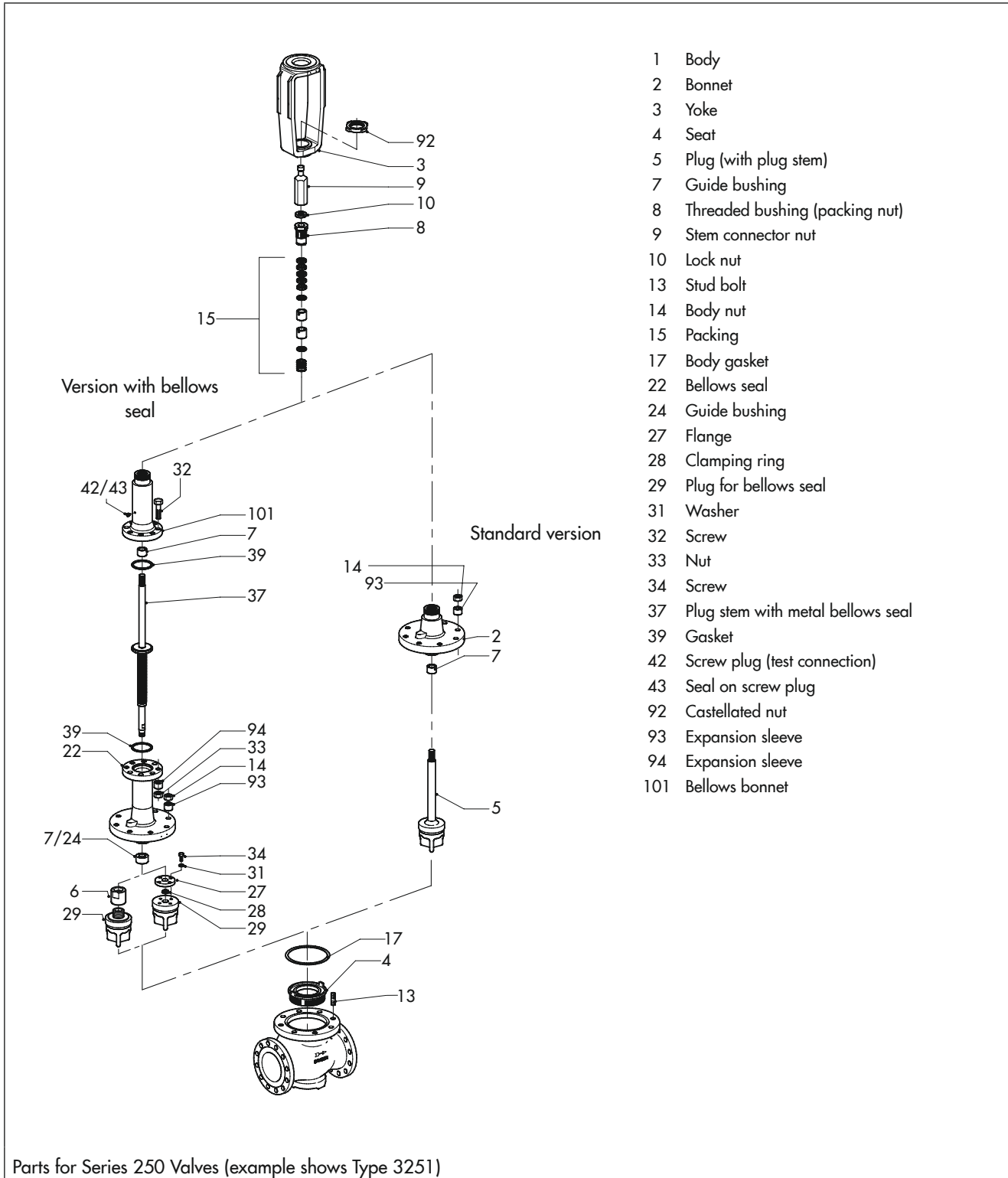

- 1 Body
- 2 Bonnet
- 3 Yoke
- 4 Seat
- 5 Plug (with plug stem)
- 7 Guide bushing
- 8 Threaded bushing (packing nut)
- 9 Stem connector nut
- 10 Lock nut
- 13 Stud bolt
- 14 Body nut
- 15 Packing
- 17 Body gasket
- 22 Bellows seal
- 24 Guide bushing
- 27 Flange
- 28 Clamping ring
- 29 Plug for bellows seal
- 31 Washer
- 32 Screw
- 33 Nut
- 34 Screw
- 37 Plug stem with metal bellows seal
- 39 Gasket
- 42 Screw plug (test connection)
- 43 Seal on screw plug
- 92 Castellated nut
- 93 Expansion sleeve
- 94 Expansion sleeve
- 101 Bellows bonnet

i Note

Other assemblies of Series 250 and 280 Valves are listed at ► www.samsongroup.com > Product documentation.

2 Tightening torques

Note concerning the following specifications

- All tightening torques specified in Nm
- Tightening torque tolerance: $\pm 10\%$
- The tightening torques are based on a friction coefficient of 0.06 with a lubricated seat thread and facing.
- After long operating times or long periods or use at temperatures above 250 °C, the breakaway torque may be twice as high as the tightening torque.
- Certain valve models (e.g. Type 3259) have their own tightening torques. Refer to the documentation for specific valve models.
- See next page for special tools available

2.1 Tightening torques to install the seat

Tightening torques in Nm · Seat (4)

Valve size		Seats made of 1.4006, 1.4462 and 2.4610		Seats made of 2.4360, 2.4856 and 1.4876		Seats made of all other materials	
DN	NPS	Without torque multiplier	With torque multiplier	Without torque multiplier	With torque multiplier	Without torque multiplier	With torque multiplier
15 to 25	½ to 1	180	– ¹⁾	140	– ¹⁾	160	– ¹⁾
32 to 40	1¼ to 1½	450	36 ²⁾	340	28 ²⁾	400	32 ²⁾
50	2	550	44 ²⁾	410	33 ²⁾	500	40 ²⁾
65 to 80	2½ to 3	1300	104 ²⁾	980	79 ²⁾	1170	94 ²⁾
100	4	1800	144 ²⁾	1350	108 ²⁾	1620	130 ²⁾
125	5	2800	70 ³⁾	2100	53 ³⁾	2520	63 ³⁾
150	6	4000	100 ³⁾	3000	75 ³⁾	3600	90 ³⁾
200	8	5000	125 ³⁾	3750	94 ³⁾	4500	113 ³⁾
DN	NPS	Without hydraulic power tool	With hydraulic power tool ⁴⁾	Without hydraulic power tool	With hydraulic power tool ⁴⁾	Without hydraulic power tool	With hydraulic power tool ⁴⁾
200	8	5000	650	3750	487	4500	585
250	10	7500	810	5650	611	6750	730
300	12	13000	1210	9800	912	11700	1088
400	16	17000	1232	12800	928	15300	1109
500	20	19000	1033	14250	775	17200	935

¹⁾ Only use a torque wrench to tighten the seat; do not use an additional torque multiplier.

²⁾ Torque multiplier with gear ratio 1:12.5 (e.g. SX30)



³⁾ Torque multiplier with gear ratio 1:40 (e.g. KWN 8000)

⁴⁾ The following multiplication factors apply when using the hydraulic power tool: DN 200: 7.7, DN 250: 9.25, DN 300: 10.75, DN 400: 13.8, DN 500: 18.4

Tightening torques

Special tools

The following tools can be used to install and remove the seat:

Valve size		Tool	Material no.	Image
DN	NPS			
125 and 150	5 and 6	Torque multiplier KWN 8000, gear ratio 1:40, max. 8000 Nm	9932-3802	
Up to 200	Up to 8	Torque multiplier SX30, gear ratio 1:12.5, max. 3000 Nm	9932-3808	
200 and larger	8 and larger	Hydraulic power tool	1280-1010	

2.2 Tightening torques for connection of body and bonnet

2.2.1 Metal body gasket · All body materials

PN	DN	Thread	No. of bolts	Tightening torque in Nm	Class	NPS	UNC thread	Quantity	Tightening torque in Nm			
40	15	M12	4	32	300	1/2	See Class 600					
	20	M12	4	32		3/4						
	25	M12	4	32		1						
	32	M12	4	44		–						
	40	M12	4	44		1 1/2						
	50	M16	4	92		2						
	65	M16	6	106		–						
	80	M16	6	106		3						
	100	M16	6	102		4						
	125	M20	6	196		–						
	150	M20	8	162		6						
	200	M27	8	470		8				1"-8	8	456
	250	M24	16	338		10				7/8"-9	16	322
	300	M27	16	464		12				1"-8	16	450
	400	M36	16	1048		16	1 3/8"-6	16	1034			
	500	M36	20	1032		20			–			

PN	DN	Thread	No. of bolts	Tightening torque in Nm	Class	NPS	UNC thread	Quantity	Tightening torque in Nm	
-	-	-	-	-	600	1/2	5/8"-11	4	60	
						3/4	5/8"-11	4	60	
						1	5/8"-11	4	60	
						1 1/2	5/8"-11	5	68	
						2	3/4"-10	6	112	
						3	3/4"-10	8	118	
						4	3/4"-10	12	90	
						6	1"-8	14	178	
						8	1 1/2"-6	8	998	
						10	1 1/2"-6	12	1074	
						12	1 3/4"-5	16	1164	
						16	1 3/4"-5	16	1974	
160	15	M16	4	80	900	1/2	See Class 1500			
	25	M16	4	80		1				
	32	M16	5	94		-				
	40	M16	5	94		1 1/2				
	50	M20	6	156		2				
	65	M20	8	168		-				
	80	M20	8	168		3	3/4"-10	8	158	
	100	M20	12	128		4	3/4"-10	12	122	
	125	M24	12	234		-	-			
	150	M24	14	220		6	1"-8	14	236	
	200	M39	8	1364		8	1 1/2"-6	8	1332	
	250	M39	12	1466		10	1 1/2"-6	12	1432	
	300	M39	16	1348		12	1 3/4"-5	16	1554	
	250 to 320	15	M20	4		164	1500	1/2	3/4"-10	4
25		M20	4	164	1	3/4"-10		4	154	
40		M20	8	118	1 1/2	3/4"-10		8	112	
50		M27	6	336	2	1 1/8"-7		6	354	
80		M27	8	360	3	1 1/8"-7		8	380	
100		M27	10	330	4	1 1/8"-7		10	350	
150		M33	12	570	6	1 1/4"-7		12	546	
200		-			8	1 3/4"-5		12	1702	
250					10	2"-4.5		12	3112	
300					16	2"-4.5		16	2866	
400	-				1/2	3/4"-10	4	178		
25				M20	4	188	1	3/4"-10	4	178
40				M20	8	136	1 1/2	3/4"-10	8	128
50				M27	6	388	2	1 1/8"-7	6	410
80				M27	10	332	3	1 1/8"-7	10	350
100				M30	10	428	4	1 1/4"-7	10	446
150				M45	10	1080	6	1 3/4"-5	10	1076
200				-			8	2 1/4"-4.5	8	3716
250							M48	16	2556	10

Tightening torques

2.2.2 Body gasket: serrated gasket - All body materials except 2.4360/B164 N04400

PN	DN	Thread	Quantity	Tightening torque in Nm	Class	NPS	UNC thread	Quantity	Tightening torque in Nm
40	15	M12	4	20	300	1/2	See Class 600		
	20	M12	4	20		3/4			
	25	M12	4	20		1			
	32/ 40	M12	4	20		1 1/2			
	50	M16	4	54		2			
	65	M16	6	54		-			
	80	M16	6	54		3			
	100	M16	6	70		4			
	125	M20	6	146		-			
	150	M20	8	130		6			
	200	M27	8	296		8	1"-8	8	350
	250	M24	16	202		10	7/8"-9	16	238
	300	M27	16	332		12	1"-8	16	392
	400	M36	16	722		16	1 3/8"-6	16	896
	500	M36	20	798		20	1 3/8"-6	20	1006
63 to 100	See PN 160				600	1/2	5/8"-11	4	30
						3/4	5/8"-11	4	30
						1	5/8"-11	4	30
						1 1/2	5/8"-11	5	46
						2	3/4"-10	6	82
						3	3/4"-10	8	116
						4	3/4"-10	12	100
						6	1"-8	14	222
						8	1 1/2"-6	8	1004
						10	1 1/2"-6	12	1030
						12	1 3/4"-5	16	1338
				16	1 3/4"-5	16	2218		
				20	2 1/4"-4.5	20	3080		
160	15	M16	4	62	900	1/2	See Class 1500		
	25	M16	4	62		1			
	32	M16	5	72		-			
	40	M16	5	72		1 1/2			
	50	M20	6	132		2			
	65	M20	8	186		-			
	80	M20	8	186		3	3/4"-10	8	170
	100	M20	12	160		4	3/4"-10	12	148
	125	M24	12	314		-	-	-	-
	150	M24	14	322		6	1"-8	14	326
	200	M39	8	1570		8	1 1/2"-6	8	1484
	250	M39	12	1616		10	1 1/2"-6	12	1526
	300	M39	16	1778		12	1 3/4"-5	16	1980
	400					16	2 1/4"-4.5	16	3480
	500					20	2 1/4"-4.5	20	4620

PN	DN	Thread	Quantity	Tightening torque in Nm	Class	NPS	UNC thread	Quantity	Tightening torque in Nm
250 to 320	15	M20	4	116	1500	½	¾"-10	4	88
	25	M20	4	116		1	¾"-10	4	88
	40	M20	8	110		1½	¾"-10	8	86
	50	M27	6	334		2	1½"-7	6	284
	80	M27	8	480		3	1½"-7	8	410
	100	M27	10	498		4	1½"-7	10	424
	150	M33	12	998		6	1¼"-7	12	746
	200	M45	8	3130		8	2"-4.5	10	2426
	250	-				10	2"-4.5	12	3068
	300					12	2¼"-4.5	16	3702
400	16				2¾"-4	16	7456		
400	15	M20	4	144	2500	½	¾"-10	4	146
	25	M20	4	144		1	¾"-10	4	146
	40	M20	8	138		1½	¾"-10	8	142
	50	M27	6	416		2	1½"-7	6	470
	80	M27	10	480		3	1½"-7	10	530
	100	M30	10	694		4	1¼"-7	10	742
	150	M45	10	2038		6	1¾"-5	10	2032
	200	-				8	2½"-4	8	6090
	250	M48	16	3464		10	2½"-4	12	6216
	300	-				12	2¾"-4	16	7452

2.2.3 Body gasket: serrated gasket · Body materials 2.4360/B164 N04400 only

PN	DN	Thread	Quantity	Tightening torque in Nm	Class	NPS	UNC thread	Quantity	Tightening torque in Nm
40	15	M12	4	16	300	½	See Class 600		
	20	M12	4	16		¾			
	25	M12	4	16		1			
	32/40	M12	4	16		1½			
	50	M16	4	40		2			
	65	M16	6	40		-			
	80	M16	6	40		3			
	100	M16	6	52		4			
	125	M20	6	110		-			
	150	M20	8	98		6			
	200	M27	8	222		8	1"-8	8	262
	250	M24	16	152		10	7/8"-9	16	178
	300	M27	16	250		12	1"-8	16	294
	400	M36	16	542		16	1¾"-6	16	672
	500	M36	20	598		20	1¾"-6	20	754

Tightening torques

PN	DN	Thread	Quantity	Tightening torque in Nm	Class	NPS	UNC thread	Quantity	Tightening torque in Nm
63 to 100	See PN 160				600	1/2	5/8"-11	4	22
						3/4	5/8"-11	4	22
						1	5/8"-11	4	22
						1 1/2	5/8"-11	5	34
						2	3/4"-10	6	62
						3	3/4"-10	8	88
						4	3/4"-10	12	76
						6	1"-8	14	166
	200	M39	8	698		8	1 1/2"-6	8	754
	250	M39	12	712		10	1 1/2"-6	12	772
300	M39	16	790	12	1 3/4"-5	16	1004		
400	M45	16	1426	16	1 3/4"-5	16	1664		
500	-			20	2 1/4"-4.5	20	2310		
160	15	M16	4	46	900	1/2	See Class 1500		
	25	M16	4	46		1			
	32	M16	5	54		-			
	40	M16	5	54		1 1/2			
	50	M20	6	100		2			
	65	M20	8	140		-			
	80	M20	8	140		3			
	100	M20	12	120		4	3/4"-10	12	111
	125	M24	12	236		-	-		
	150	M24	14	242		6	1"-8	14	244
	200	M39	8	1178		8	1 1/2"-6	8	1113
	250	M39	12	1212		10	1 1/2"-6	12	1144
	300	M39	16	1332		12	1 3/4"-5	16	1486
	400	-				16	2 1/4"-4.5	16	2610
	500	-				20	2 1/4"-4.5	20	3466
	250 to 320	15	M20	4		88	1500	1/2	3/4"-10
25		M20	4	88	1	3/4"-10		4	66
40		M20	8	82	1 1/2	3/4"-10		8	64
50		M27	6	250	2	1 1/8"-7		6	214
80		M27	8	360	3	1 1/8"-7		8	308
100		M27	10	374	4	1 1/8"-7		10	318
150		M33	12	748	6	1 1/4"-7		12	560
200		M45	8	2348	8	2"-4.5		10	1820
250		-			10	2"-4.5		12	2300
300		-			12	2 1/4"-4.5		16	2776
400	-			16	2 3/4"-4	16	5592		
400	15	M20	4	108	2500	1/2	3/4"-10	4	110
	25	M20	4	108		1	3/4"-10	4	110
	40	M20	8	104		1 1/2	3/4"-10	8	106
	50	M27	6	312		2	1 1/8"-7	6	352
	80	M27	10	360		3	1 1/8"-7	10	398
	100	M30	10	520		4	1 1/4"-7	10	556
	150	M45	10	1528		6	1 3/4"-5	10	1524
	200	-				8	2 1/2"-4	8	4568
	250	M48	16	2598		10	2 1/2"-4	12	4662
	300	-				12	2 3/4"-4	16	5590

2.2.4 Body gasket: serrated gasket · All body materials · Bolts with Xylan® coating

PN	DN	Thread	Quantity	Tightening torque in Nm	Class	NPS	UNC thread	Quantity	Tightening torque in Nm				
40	15	M12	4	16	300	½	See Class 600						
	20	M12	4	16		¾							
	25	M12	4	16		1							
	32/ 40	M12	4	16		1½							
	50	M16	4	44		2							
	65	M16	6	44		–							
	80	M16	6	44		3							
	100	M16	6	56		4							
	125	M20	6	118		–							
	150	M20	8	104		6							
	200	M27	8	238		8				1"-8	8	280	
	250	M24	16	162		10				7/8"-9	16	192	
	300	M27	16	266		12				1"-8	16	314	
	400	M36	16	578		16				1¾"-6	16	718	
500	M36	20	640	20	1¾"-6	20	806						
63 to 100	See PN 160				600	½	5/8"-11	4	24				
						¾	5/8"-11	4	24				
						1	5/8"-11	4	24				
						1½	5/8"-11	5	38				
						2	¾"-10	6	66				
						3	¾"-10	8	94				
						4	¾"-10	12	80				
						6	1"-8	14	178				
						8	1½"-6	8	804				
						10	1½"-6	12	824				
				200	M39	8	744	12	1¾"-5	16	1072		
				250	M39	12	760	16	1¾"-5	16	1776		
				300	M39	16	844	20	2¼"-4.5	20	2464		
				400	M45	16	1520						
				500	–								
160	15	M16	4	50	900	½	See Class 1500						
	25	M16	4	50		1							
	32	M16	5	58		–							
	40	M16	5	58		1½							
	50	M20	6	106		2							
	65	M20	8	150		–							
	80	M20	8	150		3				¾"-10	8	136	
	100	M20	12	128		4				¾"-10	12	120	
	125	M24	12	252		–							
	150	M24	14	258		6				1"-8	14	262	
	200	M39	8	1256		8				1½"-6	8	1188	
	250	M39	12	1294		10				1½"-6	12	1222	
	300	M39	16	1424		12				1¾"-5	16	1584	
	400					16				2¼"-4.5	16	2784	
500					20	2¼"-4.5	20	3696					

Tightening torques

PN	DN	Thread	Quantity	Tightening torque in Nm	Class	NPS	UNC thread	Quantity	Tightening torque in Nm
250 to 320	15	M20	4	94	1500	1/2	3/4"-10	4	72
	25	M20	4	94		1	3/4"-10	4	72
	40	M20	8	88		1 1/2	3/4"-10	8	70
	50	M27	6	268		2	1 1/8"-7	6	228
	80	M27	8	384		3	1 1/8"-7	8	328
	100	M27	10	400		4	1 1/8"-7	10	340
	150	M33	12	800		6	1 1/4"-7	12	598
	200	M45	8	2504		8	2"-4.5	10	1942
	250	-				10	2"-4.5	12	2456
	300					12	2 1/4"-4.5	16	2962
400	16				2 3/4"-4	16	5966		
400	15	M20	4	116	2500	1/2	3/4"-10	4	118
	25	M20	4	116		1	3/4"-10	4	118
	40	M20	8	112		1 1/2	3/4"-10	8	114
	50	M27	6	334		2	1 1/8"-7	6	376
	80	M27	10	384		3	1 1/8"-7	10	424
	100	M30	10	556		4	1 1/4"-7	10	594
	150	M45	10	1632		6	1 3/4"-5	10	1626
	200	-				8	2 1/2"-4	8	4872
	250	M48	16	2772		10	2 1/2"-4	12	4974
	300	-				16	2 3/4"-4	16	5962

2.3 Tightening torques for connection of bellows seal and bellows seal bonnet

2.3.1 All body materials

PN	DN	Thread	Quantity	Tightening torque in Nm	Class	NPS	UNC thread	Quantity	Tightening torque in Nm
16 to 40	15 to 40	M16	4	40	150 to 300	1/2 to 1 1/2	5/8"-11	4	42
	50 to 100	M16	6	38		2 to 4	5/8"-11	6	40
	125	M20	6	72		5	3/4"-10	6	70
	150					6			
	200	M27	8	110		8	1"-8	8	108
	250					10			
	300					12			
	400					16			
	500					20			
63 to 160	15 to 40	M16	4	80	600 to 900	1/2 to 1 1/2	5/8"-11	4	80
	50 to 100	M16	6	78		2 to 4	5/8"-11	6	76
	125	M20	6	142		5	3/4"-10	6	136
	150					6			
	200	M27	8	222		8	1"-8	8	212
	250					10			
	300					12			
	400					16			
500	-			20					

PN	DN	Thread	Quantity	Tightening torque in Nm	Class	NPS	UNC thread	Quantity	Tightening torque in Nm
250	15 to 40	M20	4	164	1500	½ to 1½	¾"-10	4	154
	50 to 80	M20	6	156		2 to 3	¾"-10	6	148
320 to 400	15 to 40	M20	4	188	2500	½ to 1½	¾"-10	4	178
	50 to 80	M20	8	136		2 to 3	¾"-10	8	128

2.3.2 Special version with large plug stem

PN	DN	d _{Kst} in mm	Thread	Quantity	Tightening torque in Nm	Class	NPS	d _{Kst} in mm	UNC thread	Quantity	Tightening torque in Nm
160	25	16	16	4	62	600	½	16	⅝"-11	4	30
	-						1½	16	⅝"-11	5	46
							2	25	¾"-10	6	82
							3	25	¾"-10	8	116
							4	25	¾"-10	12	100
							6	40	1"-8	14	222
250	-					1500	4	25	1⅝"-7	10	424
320 to 400	-					2500	2	25	¾"-10	8	100
	80	25	20	6	120		3	25	1⅝"-7	6	180

3 Lubricant

⚠ WARNING

Damage to health after contact with hazardous substances.

Certain lubricants (e.g. 8150-4008) are classified as hazardous substances. These substances have a special label and a material safety data sheet (MSDS) issued by the manufacturer.

→ Make sure that an MSDS is available for any hazardous substance used. If necessary, contact the manufacturer to obtain an MSDS.

→ Inform operating personnel about the hazardous substances and their correct handling.

3.1 Recommended lubricant

Application	Quantity [g]	Temperature range in °C	Color	Material no. of lubricant
Valves for oxygen service (free of oil and grease)	60	-60 to +250	White	8150-0116
Pneumatic devices (O-rings, guide bearings)	-	-40 to +260	White/transparent	8150-0100
Seat thread, stud bolts, spring compression	100	-180 to +1200	Gray	8150-4010
	250			8150-4008
Plug stem seal	10	-200 to +220	White	8150-4000
	60			8150-4007
	650			8150-0073

3.2 Lubricant for adjustable packings

For valve materials EN-GJL-250 (EN-JL 1040), EN-GJS-400-18-LT (EN-JL 1049), 1.0619, 1.0402, 1.4571 and 1.4581

Packing form	Material no. of lubricant	Packing number					
		DN 15 to 40 NPS ½ to 1½	DN 50 to 100 NPS 2 to 4	DN 125 to 150 NPS 5 to 6	DN 200 NPS 8	DN 250 NPS 10	DN 300 to 400 NPS 12 to 16
A	8150-0111	1120-1957	1120-1958	1120-1959	1120-1955	1120-1956	1120-1956
B		1120-1962	1120-1963	1120-1964	1120-1965 ¹⁾	1120-1966	1120-1966
Standard		1120-1952	1120-1953	1120-1954	1120-1955	1120-1956	1120-1956
H	Do not use any lubricant.	1120-1972	1120-1973	1120-1974	1120-1975	1120-1976	1120-1976

¹⁾ No V-ring packing

3.3 Lubricant sorted by parts and versions

Application	Seat	Plug	Stud bolt	Packing
Number within drawing (see section 1.5)	4	5	13	15
Series 250	8150-4008	8150-4000/ 8150-4007/ 8150-0073	8150-4008	8150-4000/ 8150-4007/ 8150-0073
Version for gas (DIN EN 161)	8150-4008	8150-4000/ 8150-4007/ 8150-0073	8150-4008	8150-4000/ 8150-4007/ 8150-0073
Version for oxygen service (cold box)	8150-0116	8150-0116	8150-0116	8150-0116
Application	Bolt (bellows seal)	Plug stem with metal bellows		
Number within drawing (see section 1.5)	32	37		
Series 250	8150-4008	8150-4008		
Version for gas (DIN EN 161)	8150-4008	8150-4008		
Version for oxygen service (cold box)	8150-0116	8150-0116		

4 Tools

4.1 Tools for assembly and disassembly

Packing tool

Valve size		Tool	Material no.	Image
DN	NPS			
15 to 40	½ to 1½	Packing tool (12 mm plug stem diameter)	1280-3039	
50 to 100	2 to 4	Packing tool (16 mm plug stem diameter)	1280-3038	
125 to 150	5 to 6	Packing tool (25 mm plug stem diameter)	1280-3040	
200 and larger	8 and larger	Packing tool (40 mm plug stem diameter)	1280-3041	

Packing extractor

Valve size		Tool	Material no.	Image
DN	NPS			
15 to 40	½ to 1½	Packing extractor	1280-3037	
50 to 500	2 to 20	Packing extractor	1280-3035	
200 to 500	8 to 20	Packing extractor to pull out spacers out of the packing chamber	1280-3036	

Hook wrench for threaded bushing



Valve size		Tool	Material no.	Image
DN	NPS			
200 and larger	8 and larger	Hook wrench to loosen and tighten the threaded bushing (packing nut)	1280-3000	

Tool for high-temperature packings

Valve size		Tool	Material no.	Image
DN	NPS			
15 to 40	½ to 1½	Tool (modified threaded bushing), 12 mm plug stem diameter	1280-2007	
50 to 100	2 to 4	Tool (modified threaded bushing), 16 mm plug stem diameter	1280-2006	
125 to 150	5 to 6	Tool (modified threaded bushing), 25 mm plug stem diameter	1280-2008	
200 to 500	8 to 20	Tool (modified threaded bushing), 40 mm plug stem diameter	1280-2009	

4.2 Lifting equipment

Valve size		Tool	Material no.	Image
DN	NPS			

15 to 40	½ to 1½	Sling for bonnet (200 kg working load limit)	1280-3032	
50 to 100	2 to 4	Sling for bonnet (200 kg working load limit)	1280-3033	
125 to 400	5 to 16	Sling for bonnet (2500 kg working load limit)	1280-3034	
200 and larger	8 and larger	Ring nut to lift large plug with 40 mm plug stem diameter Connecting thread: M36x1.5	1280-3093	

1 Information on Type 3251 and Type 3256 Valves

1.1 Technical data for Type 3251

		Type 3251
Image		
Valve size	DIN	DN 15 to 500
	ANSI	NPS ½ to 20
Associated product documentation	Data sheet	▶ T 8051 (DIN) and ▶ T 8052 (ANSI)
	Mounting and operating instructions	▶ EB 8051 (DIN) and ▶ EB 8052 (ANSI)

1.2 Technical data for Type 3256

		Type 3256
Image		
Valve size	DIN	DN 15 to 500
	ANSI	NPS ½ to 20
Associated product documentation	Data sheet	▶ T 8065 (DIN) and ▶ T 8066 (ANSI)
	Mounting and operating instructions	▶ EB 8065 (DIN) and ▶ EB 8066 (ANSI)

1.3 Parts

Parts of the valve assembly are listed in the Parts section for Series 250 Valves.

2 Tools

2.1 Tools for standard version





2.1.1 Seat wrenches

Valve size		Pressure rating	Material no.	Photo/tool
DN	NPS			
15 to 25	½ to 1	–	0440-0065	
32 to 40	1¼ to 1½	–	1280-0110	
50	2	–	1280-0211	
65 to 80	2½ to 3	–	1280-0311	
100	4	–	1280-0411	
125	5	–	1280-3159	
150 ¹⁾	6	–	1280-3157	
200	8	PN 16 to 160 Class 150 to 900	1280-1000	
250	10	PN 16 to 160 Class 150 to 900	1280-1101	
300	12	PN 16 to 160 Class 150 to 900	1280-1200	
300	12	PN 250 to 400 Class 1500 to 2500	1280-1201	
350 to 400	14 to 16	PN 16 to 160	1280-1300	
400	16	PN 250 Class 1500	1280-1305	
500	20	PN 10 to 160	1280-1400	

¹⁾ Special socket for AC-1, AC-2, AC-3 and AC-5 trims for seat wrench (1280-3157). See section 2.5.2.

Special tools

The following tools are additionally required to install and remove the seat:

Valve size		Tool	Material no.	Image
DN	NPS			
32 to 150	1¼ to 6	Torque multiplier SX30, gear ratio 1:12.5, max. 3000 Nm	9932-3808	
125 and 150	6	Torque multiplier KWN8000 – Transmission ratio 1:40 – Max. 8000 Nm Torque multiplier BOLTMAX MX80 – Transmission ratio 1:49 – Max. 8000 Nm	9932-3802	
32 to 50	1¼ to 2	Torque wrench	9932-3812	
80 to 150	3 to 6	Torque wrench	9932-3814	
200 to 500	8 to 20	Hydraulic power tool	1280-1010	

i Note

Both the torque multipliers KWN8000 and BOLTMAX MX80 have the same material number. However, they have different gear ratios and spare shear pins. Therefore, always check which torque multiplier you are using.

2.1.2 Tools for guide bushing



Special tools are required to mount or remove guide bushings in standard valves:

Disassembly tool

Valve size		Tool	Material no.	Image
DN	NPS			
15 to 500	½ to 20	Disassembly tool	1280-4013	–

Tools

Assembly tools

Valve size		Tool	Material no.	Image
DN	NPS			
15 to 40	½ to 1½	Assembly tool	1280-0608	
50 to 100	2 to 4	Assembly tool	1280-3063	
125 to 150	6	Assembly tool	1280-0612	
200 to 500	8 to 20	Assembly tool	1280-3102	
200 to 500 ¹⁾	8 to 20 ¹⁾	Assembly tool	1280-3103	

Caulking tools

Valve size		Tool	Material no.	Image
DN	NPS			
15 to 40	½ to 1½	Caulking tool	1280-0609	
50 to 100	2 to 4	Caulking tool	1280-3064	
125 to 150	6	Caulking tool	1280-3146	

2.2 Tools for version with insulating section or bellows seal



2.2.1 Tools for guide bushing

Special tools are required to mount or remove guide bushings in valves with insulating section or bellows seal:

Disassembly tool

Valve size		Tool	Material no.	Image
DN	NPS			
15 to 500	½ to 20	Disassembly tool	1280-4013	–

Assembly tools for version with insulating section

Valve size		Tool	Material no.	Image
DN	NPS			
15 to 40	½ to 1½	Assembly tool	1280-0608	
50 to 100	2 to 4	Assembly tool	1280-3063	
125 to 150	6	Assembly tool	1280-0612	
200 to 500	8 to 20	Assembly tool	1280-3102	
200 to 500 ¹⁾	8 to 20 ¹⁾	Assembly tool	1280-3103	

Caulking tools for version with insulating section

Valve size		Tool	Material no.	Image
DN	NPS			
15 to 40	½ to 1½	Caulking tool	1280-0609	
50 to 100	2 to 4	Caulking tool	1280-3064	
125 to 150	6	Caulking tool	1280-3146	

Assembly tools for version with bellows seal

Valve size		Tool	Material no.	Image
DN	NPS			
125 to 150	6	Assembly tool	1280-3104	-
125 to 150	6	Assembly tool	1280-3106	
200 to 500	8 to 20	Assembly tool	1280-3105	
200 to 500 ¹⁾	8 to 20 ¹⁾	Assembly tool	1280-3107	

Caulking tools for version with bellows seal



Valve size		Tool	Material no.	Image
DN	NPS			
15 to 40	½ to 1½	Caulking tool	1280-3092	-
50 to 100	2 to 4	Caulking tool	1280-3090	

2.3 Tools for version with pressure balancing

Special wrench fittings and torque wrenches are required for Type 3251 Valves with pressure balancing with ring nut to install the ring nut. No special tools are required for valve versions with clamping rings.

i Note

Contact SAMSON's After-sales Service to find out which version is used in the valve (ring nut or clamping ring).

Valve size			Wrench fitting		Ring nut	Torque wrench	
DN	NPS	Seat bore	Material no.	Image	Material no.	Material no.	Image
80	3	80	1280-6043		0250-1702	9932-2268	
100	4						
150	6	100	1280-6044		0250-1704		
200	8	125	1280-6046		0250-1715		
250	10						
300	12						
150 to 400	6 to 16	150	1280-6045		0250-1791		
200 to 300	8 to 12	150	1280-2145	0250-2145			

Tools

2.4 Tools for PSA valves

The Type 3256 Angle Valve is not available as a PSA valve.

2.4.1 Tools for guide bushing

Special tools are required to mount or remove guide bushings in PSA valves:

Disassembly tool

Valve size		Tool	Material no.	Image
DN	NPS			
15 to 500	½ to 20	Disassembly tool	1280-4013	–

Assembly tools

Valve size		Tool	Material no.	Image
DN	NPS			
15 to 40	½ to 1½	Assembly tool	1280-3153	–
125 to 150	6	Assembly tool	1280-3152	





2.5 Tools for valves with AC trims

2.5.1 Seat wrenches for AC trims

Valve size		AC trim	Material no.	Image
DN	NPS			
25	1	AC-3, AC-5	0440-0065	
32 to 40	1½	AC-3, AC-5	1280-0110	
50	2	AC-1, AC-2, AC-3, AC-5	1280-0211	
80	3	AC-1, AC-2, AC-3, AC-5	1280-0311	
100	4	AC-1, AC-2	0410-3028	
100	4	AC-3, AC-5	1280-0411	
150	6	AC-1, AC-2, AC-3, AC-5	1280-3154	–
200	8	AC-1, AC-2	1280-1005 1280-1010	

Special tools

The following tools are additionally required to install and remove the seat with AC trims:

Valve size		Tool	Material no.	Image
DN	NPS			
Up to 100	Up to 4	Torque multiplier SX30, gear ratio 1:12.5, max. 3000 Nm	9932-3808	
125 and 150	6	Torque multiplier KWN8000 – Transmission ratio 1:40 – Max. 8000 Nm Torque multiplier BOLTMAX MX80 – Transmission ratio 1:49 – Max. 8000 Nm	9932-3802	
32 to 50	1¼ to 2	Torque wrench	9932-3812	
80 to 150	3 to 6	Torque wrench	9932-3814	
200 to 500	8 to 20	Hydraulic power tool	1280-1010	

i Note

Both the torque multipliers KWN8000 and BOLTMAX MX80 have the same material number. However, they have different gear ratios and spare shear pins. Therefore, always check which torque multiplier you are using.

2.5.2 Socket for AC trims

Valve size		Tool	Material no.	Image
DN	NPS			
100	4	Socket for AC-1 and AC-2 trims for seat wrench (0410-3028)	0440-0069	
150	6	Special socket for AC-1, AC-2, AC-3 and AC-5 trims for seat wrench (1280-3157)	0440-0259	–

1 Information on Type 3253 Valve

1.1 Technical data

		Type 3253
Image		
Valve size	DIN	DN 15 to 500
	ANSI	NPS ½ to 20
Style		Three-way valve
Associated product documentation	Data sheet	▶ T 8055 (DIN) ▶ T 8056 (ANSI)
	Mounting and operating instructions	▶ EB 8055 (DIN) ▶ EB 8056 (ANSI)

1.2 Parts

Parts of the valve assembly are shown on the next page.

1 Body	37 Plug stem with metal bellows	83 Hanger
2 Bonnet	39 Gasket	84 Travel indicator scale
3 Yoke	40 Nut	85 Screw
4 Seat	60 Yoke assembly with anti-rotation fixture	91 Protective cap
5 Plug	60.1 Anti-rotation fixture	92 Castellated nut
7 Guide bushing	60.2 Holder	93 Expansion sleeve
8 Threaded bushing (packing nut)	60.10 Bushing	117 Expansion sleeve
9 Stem connector nut	60.11 Bushing	224 Snap ring
10 Lock nut	60.12 Hex screw	225 Nut
11 Spring	60.13 Hex screw	230 Ring (anti-rotation fixture)
12 Washer	60.14 Washer	231 Seat holder
13 Stud bolt	60.15 Threaded pin	
14 Body nut	60.16 Ball bearings (anti-rotation fixture)	
15 Packing	60.17 Sliding washer	
16 V-ring packing	73 Stud bolt	
17 Body gasket	75 Sleeve	
19 Bushing	76 Sleeve	
20 Seat body	80 Nameplate	
21 Insulating section	81 Grooved pin	
36 Plug stem	82 Screw	

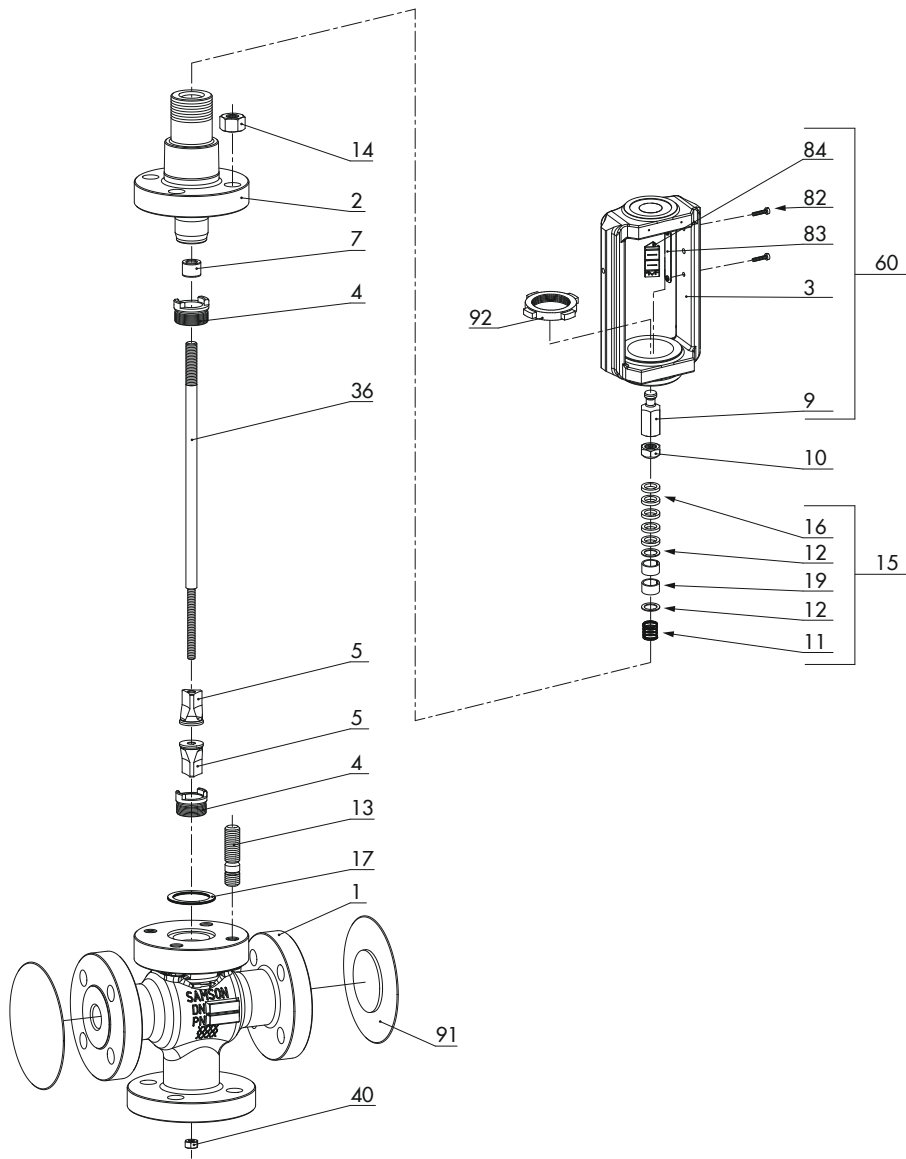

Single-piece body up to DN 40

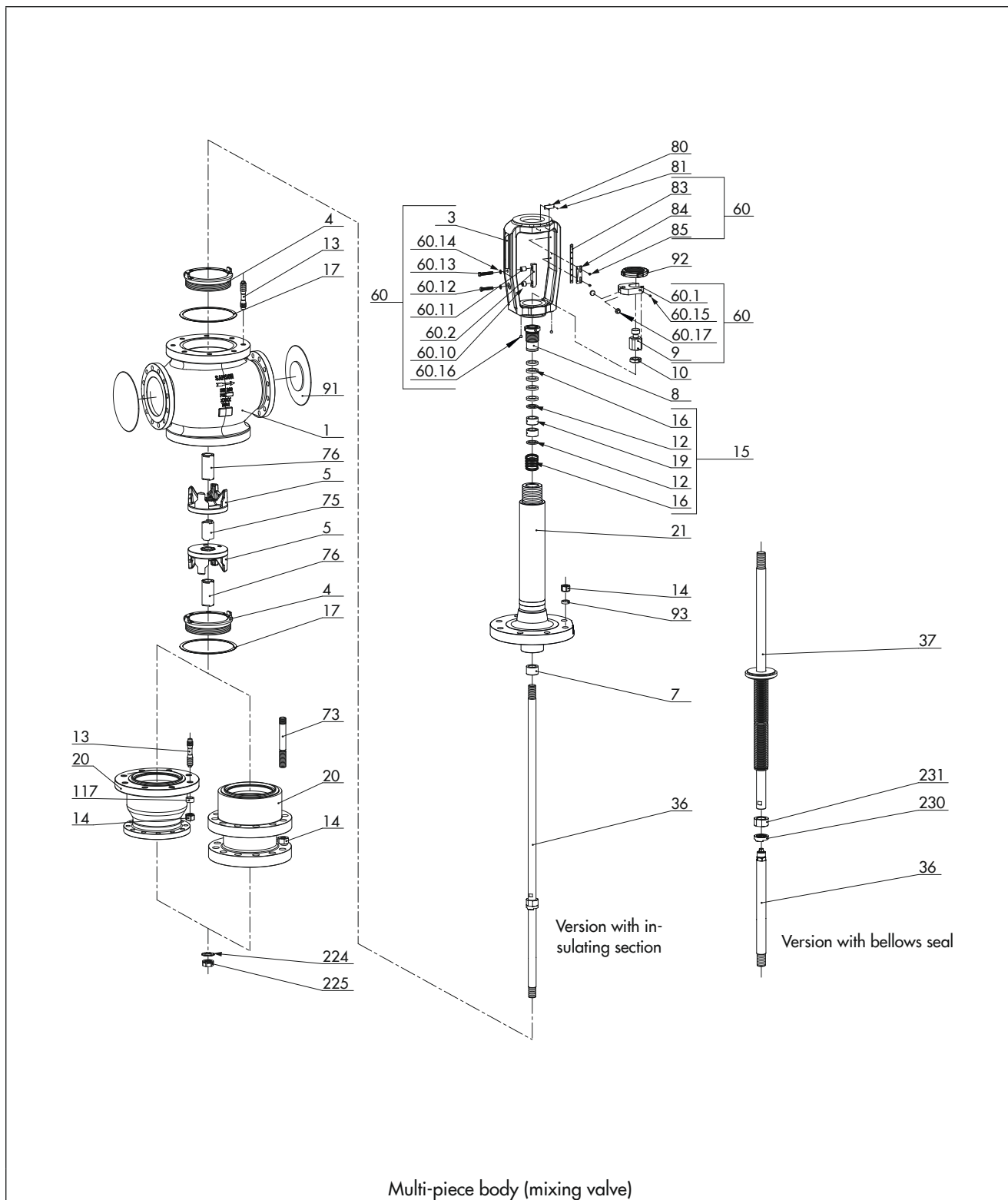

2 Tightening torques

2.1 Tightening torques for nut at the plug stem end in version with standard bonnet or insulating section

Valve size		Tightening torque for nut (225) in Nm
DN	NPS	
80	3	60
150	6	300
200 to 400	8 to 16	450

2.2 Tightening torques for nut at the plug stem end in version with bellows seal

Valve size		Tightening torque for nut (225) in Nm
DN	NPS	
80	3	60
150	6	300
200 to 400	8 to 16	450

2.3 Tightening torques for seat holder in version with bellows seal

Valve size		Tightening torque for nut (231) in Nm
DN	NPS	
80	3	120
150	6	300
200 to 400	8 to 16	450



2.4 Other tightening torques

Further tightening torques are listed in the section on tightening torques for Series 250 and 280 Valves.

3 Tools

3.1 Seat wrenches

3.1.1 Seat wrenches for single-piece body

Valve size		Pressure rating	Material no.	Image
DN	NPS			
15 to 25	½ to 1	–	1280-0112	
32 to 40	1¼ to 1½	–	1280-0110	
50	2	–	1280-0211	
65 to 80	2½ to 3	–	1280-0311	
100	4	–	1280-0411	
200	8	PN 63 to 160	1280-1003	
		PN 250 to 400	1280-1008	
250	10	PN 63 to 160	1280-1105	
		PN 250 to 400	1280-1107	
300	12	PN 63 to 160	1280-1203	
		PN 250 to 400	1280-1206	
400	16	PN 250 to 320	1280-1304	

3.1.2 Seat wrenches for multi-piece body

Valve size		Pressure rating	Material number of seat wrench for top seat	Material number of seat wrench for bottom seat
DN	NPS			
50	2	–	1280-0211	
65 to 80	2½ to 3	–	1280-0311	
100	4	–	1280-0411	
150	6	–	1280-3158	
200	8	PN 10 to 40	1280-1000	1280-1002
		PN 63 to 160	1280-1000	1280-1004
250 ¹⁾	10 ¹⁾	PN 63 to 160	1280-1100	1280-1103
250 ²⁾	10 ²⁾	PN 10 to 160	1280-1101	1280-1103
250	10	PN 63 to 160	1280-1101	1280-1105
–	10	Class 300	1280-1101	1280-1106
300	12	PN 10 to 160	1280-1200	1280-1205
400	16	PN 10 to 160	1280-1300	1280-1303
500	20	PN 10 to 40	1280-1400	1280-1401





¹⁾ Valves until October 1996

²⁾ Valves from October 1996



3.1.3 Additional tools

The following tools are additionally required to install and remove the seat:

Valve size		Tool	Material no.	Image
DN	NPS			
32 to 150	1¼ to 6	Torque multiplier SX30, gear ratio 1:12.5, max. 3000 Nm	9932-3808	
125 and 150	6	Torque multiplier KWN8000 – Transmission ratio 1:40 – Max. 8000 Nm Torque multiplier BOLTMAX MX80 – Transmission ratio 1:49 – Max. 8000 Nm	9932-3802	
32 to 50	1¼ to 2	Torque wrench	9932-3812	
80 to 150	3 to 6	Torque wrench	9932-3814	

Tools

Valve size		Tool	Material no.	Image
DN	NPS			
200 to 500	8 to 20	Hydraulic power tool	1280-1010	

i Note

Both the torque multipliers KWN8000 and BOLTMAX MX80 have the same material number. However, they have different gear ratios and spare shear pins. Therefore, always check which torque multiplier you are using.



1 Information on Type 3254 Valve

1.1 Technical data for Type 3254

		Type 3254
Image		
Valve size	DIN	DN 80 to 500
	ANSI	NPS 3 to 20
Associated product documentation	Data sheet	▶ T 8060 (DIN) and ▶ T 8061 (ANSI)
	Mounting and operating instructions	▶ EB 8060 (DIN) and ▶ EB 8061 (ANSI)

1.2 Parts

Parts of the valve assembly are listed in the Parts section for Series 250 Valves.

2 Tools





2.1 Tools for standard version

2.1.1 Seat wrenches

Valve size		Pressure rating	Material no.	Image
DN	NPS			
15 to 25	½ to 1	–	0440-0065	
32 to 40	1¼ to 1½	–	1280-0110	
50	2	–	1280-0211	
65 to 80	2½ to 3	–	1280-0311	
100	4	–	1280-0411	
125	5	–	1280-3159	
150	6	–	1280-3157	
200	8	PN 10 to 160 Class 150 to 900	1280-1000	
200	8	PN 250 to 400 Class 1500 to 2500	1280-1001	
250	10	PN 10 to 40 Class 150 to 300	1280-1100	
250	10	PN 10 to 160 Class 150 to 900	1280-1101	
250	10	PN 250 to 400 Class 1500 to 2500	1280-1102	
300	12	PN 10 to 160 Class 150 to 900	1280-1200	
300	12	PN 250 to 400 Class 1500 to 2500	1280-1201	
400	16	PN 10 to 160 Class 150 to 900	1280-1300	
400	16	PN 250 Class 1500	1280-1305	
500	20	PN 10 to 160 Class 150 to 900	1280-1400	

Special tools

The following tools are additionally required to install and remove the seat:

Valve size		Tool	Material no.	Image
DN	NPS			
32 to 150	1¼ to 6	Torque multiplier SX30, gear ratio 1:12.5, max. 3000 Nm	9932-3808	
125 and 150	6	Torque multiplier KWN8000 – Transmission ratio 1:40 – Max. 8000 Nm Torque multiplier BOLTMAX MX80 – Transmission ratio 1:49 – Max. 8000 Nm	9932-3802	
32 to 50	1¼ to 2	Torque wrench	9932-3812	
80 to 150	3 to 6	Torque wrench	9932-3814	
200 to 500	8 to 20	Hydraulic power tool	1280-1010	

i Note



Both the torque multipliers KWN8000 and BOLTMAX MX80 have the same material number. However, they have different gear ratios and spare shear pins. Therefore, always check which torque multiplier you are using.

2.2 Tools for version with pressure balancing

Special wrench fittings and torque wrenches are required for Type 3254 Valves with pressure balancing with ring nut to install the ring nut. No special tools are required for valve versions with clamping rings.





i Note

Contact SAMSON's After-sales Service to find out which version is used in the valve (ring nut or clamping ring).

Valve size		Seat bore	Wrench fitting		Ring nut	Torque wrench	
DN	NPS		Material no.	Image	Material no.	Material no.	Image
80	3	80	1280-6043		0250-1702	9932-2268	
100	4						
150	6	100	1280-6044		0250-1704		
200	8	125	1280-6046		0250-1715		
250	10						
300	12						
150 to 400	6 to 16	150	1280-6045		0250-1797		
200 to 300	8 to 12	150	1280-6047	0250-2145			

2.3 Tools for valves with AC trims





2.3.1 Seat wrenches for AC trims

Valve size		AC trim	Material no.	Image
DN	NPS			
25	1	AC-3, AC-5	0440-0065	
32 to 40	1½	AC-3, AC-5	1280-0110	
50	2	AC-1, AC-2, AC-3, AC-5	1280-0211	
80	3	AC-1, AC-2, AC-3, AC-5	1280-0311	
100	4	AC-1, AC-2	0440-0069 0410-3028	
100	4	AC-3, AC-5	1280-0411	

Valve size		AC trim	Material no.	Image
DN	NPS			
150	6	AC-1, AC-2, AC-3, AC-5	1280-3157 0440-0259	–
200	8	AC-1, AC-2	1280-1005	

Special tools

The following tools are additionally required to install and remove the seat with AC trims:

Valve size		Tool	Material no.	Image
DN	NPS			
Up to 100	Up to 4	Torque multiplier SX30, gear ratio 1:12.5, max. 3000 Nm	9932-3808	
125 and 150	6	Torque multiplier KWN8000 – Transmission ratio 1:40 – Max. 8000 Nm Torque multiplier BOLTMAX MX80 – Transmission ratio 1:49 – Max. 8000 Nm	9932-3802	
32 to 50	1¼ to 2	Torque wrench	9932-3812	
80 to 150	3 to 6	Torque wrench	9932-3814	
200 to 500	8 to 20	Hydraulic power tool	1280-1010	

i Note

Both the torque multipliers KWN8000 and BOLTMAX MX80 have the same material number. However, they have different gear ratios and spare shear pins. Therefore, always check which torque multiplier you are using.



1 Information on Type 3259 Valve

1.1 Technical data

		Type 3259
Image		
Valve size	DIN	DN 16, 24, 30, 45, 58, 70, 90
Associated product documentation	Data sheet	▶ T 8059
	Mounting and operating instructions	▶ EB 8059

1.2 Parts

Parts of the assembly of Series 250 Valves apply to Type 3259 Valves.

2 Tightening torques

2.1 Tightening torques to install the seat

PN	Valve size	Seat thread	Tightening torque in Nm
325	16, 24 and 30	M36x1.5	340
	45 and 58	M58x1.5	1200
	70 and 90	M100x2	3000

2.2 Tightening torques for connection of body and intermediate piece

i Note

The specified tightening torques for the connection of body and insulating section (21) or body and bellows seal (22) apply to the version with insulating section or bellows seal.

Material: K2/1.7218				
PN	DN	UNC thread	Quantity	Tightening torque for body nut (14) in Nm
325	16, 24 and 30	7/8"-9	6	150
	45 and 58	1 1/8"-7	6	300
	70 and 90	1 1/2"-6	8	900

2.3 Tightening torques for connection of threaded flange and bellows seal

Material: K2/1.7218				
PN	DN	UNC thread	Quantity	Tightening torque for nut (33) in Nm
325	16 to 58	7/8"-9	6	70
	70 and 90	1 1/4"-7	6	240





3 Tools

3.1 Seat wrenches

Valve size DN	Tool	Material no.	Image
16, 24 and 30	Seat wrench	1280-0004	
45 and 58	Seat wrench (consisting of pin, socket, extension and flange)	1280-0003	
70 and 90	Seat wrench (consisting of pin, socket, extension and flange)	1280-0002	

Special tools

The following tools are additionally required to install and remove the seat:

Valve size		Tool	Material no.	Image
DN	NPS			
32 to 150	1¼ to 6	Torque multiplier SX30, gear ratio 1:12.5, max. 3000 Nm	9932-3808	
32 to 50	1¼ to 2	Torque wrench	9932-3812	
80 to 150	3 to 6	Torque wrench	9932-3814	
200 to 500	8 to 20	Hydraulic power tool	1280-1010	

1 Information on Type 3281 and Type 3286 Valves

1.1 Technical data for Type 3281

		Type 3281
Image		
Form		Globe valve
Valve size	DIN	DN 50 to 300
	ANSI	NPS 1 to 12
Associated product documentation	Data sheet	▶ T 8251 (DIN) and ▶ T 8252 (ANSI)
	Mounting and operating instructions	▶ EB 8251 (DIN) and ▶ EB 8252 (ANSI)

1.2 Technical data for Type 3286







		Type 3286
Image		
Form		Angle valve
Valve size	DIN	DN 50 to 300
	ANSI	NPS 1 to 12
Associated product documentation	Data sheet	▶ T 8256 (DIN) and ▶ T 8257 (ANSI)
	Mounting and operating instructions	▶ EB 8256 (DIN) and ▶ EB 8257 (ANSI)

1.3 Parts

The Type 3281 and Type 3286 Steam Conditioning Valves are almost identical to a Type 3251 Globe Valve or Type 3256 Angle Valve fitted with a flow divider ST 3. Parts of the valve assembly are listed in the Parts section for Series 250 Valves.





2 Tools

2.1 Seat wrenches

Valve size		Pressure rating	Material no.	Image
DN	NPS			
15 to 25	½ to 1	–	0440-0065	
32 to 40	1¼ to 1½	–	1280-0110	
50	2	–	1280-0211	
65 to 80	2½ to 3	–	1280-0311	
100	4	–	1280-0411	
125	5	–	1280-3159	
150	6	–	1280-3157	
125 to 150	6	–	1280-3154	
200	8	PN 16 to 160 Class 150 to 900	1280-1000	
250	10	PN 16 to 160 Class 150 to 900	1280-1101	
300	12	PN 16 to 160 Class 150 to 900	1280-1200	

Special tools

The following tools are additionally required to install and remove the seat:

Valve size		Tool	Material no.	Image
DN	NPS			
32 to 150	1¼ to 6	Torque multiplier SX30, gear ratio 1:12.5, max. 3000 Nm	9932-3808	
125 and 150	6	Torque multiplier KWN8000 – Transmission ratio 1:40 – Max. 8000 Nm Torque multiplier BOLTMAX MX80 – Transmission ratio 1:49 – Max. 8000 Nm	9932-3802	
32 to 50	1¼ to 2	Torque wrench	9932-3812	
80 to 150	3 to 6	Torque wrench	9932-3814	
200 to 300	8 to 12	Hydraulic power tool	1280-1010	

i Note

Both the torque multipliers KWN8000 and BOLTMAX MX80 have the same material number. However, they have different gear ratios and spare shear pins. Therefore, always check which torque multiplier you are using.



1 Information on Series 290 Valves

1.1 Technical data

		Series 290
Valve size	DIN	–
	ANSI	NPS ½ to 8
Pressure rating	DIN	–
	ANSI	Class 150 to 900
Models		Type 3291 (globe valve)
		Type 3296 (angle valve)
Features		Clamped-in seat

1.2 Parts

Parts of the valve assembly are shown on the next page.

Legend for exploded diagram

1	Body	39	Gasket (bonnet)
2	Bonnet	42	Screw plug (test connection)
3	Yoke	43	Seal
4	Seat	44	Ring (pressure balancing)
5	Plug (with plug stem)	45	Gasket (pressure balancing)
6	Nut	46	Gasket (pressure balancing)
7	Guide bushing	47	Support (pressure balancing)
8	Threaded bushing (packing nut)	48	Hex screw (pressure balancing)
9	Stem connector nut	49	Hex screw (pressure balancing)
10	Lock nut	50	Washer (pressure balancing)
11	Spring	51	Guide ring (several guides only for version with graphite seal)
12	Washer	52	Ring (pressure balancing)
13	Stud bolt	53	Retaining ring (pressure balancing)
14	Body nut	60	Yoke assembly
15	Packing	80	Nameplate
16	V-ring packing	81	Grooved pin
17	Body gasket	82	Screw
19	Bushing	83	Hanger
21	Insulating section	84	Travel indicator scale
22	Bellows seal	85	Screw
24	Guide bushing	91	Protective cap
26	Label	92	Castellated nut
27	Flange	101	Bellows bonnet
28	Clamping ring	102	Snap ring
29	Plug for version with bellows seal	124	Seat retainer
31	Washer	125	Spacer ring
32	Screw	126	Seat retainer gasket
33	Nut	127	Seat bridge gasket
34	Screw		
37	Plug stem with metal bellows		

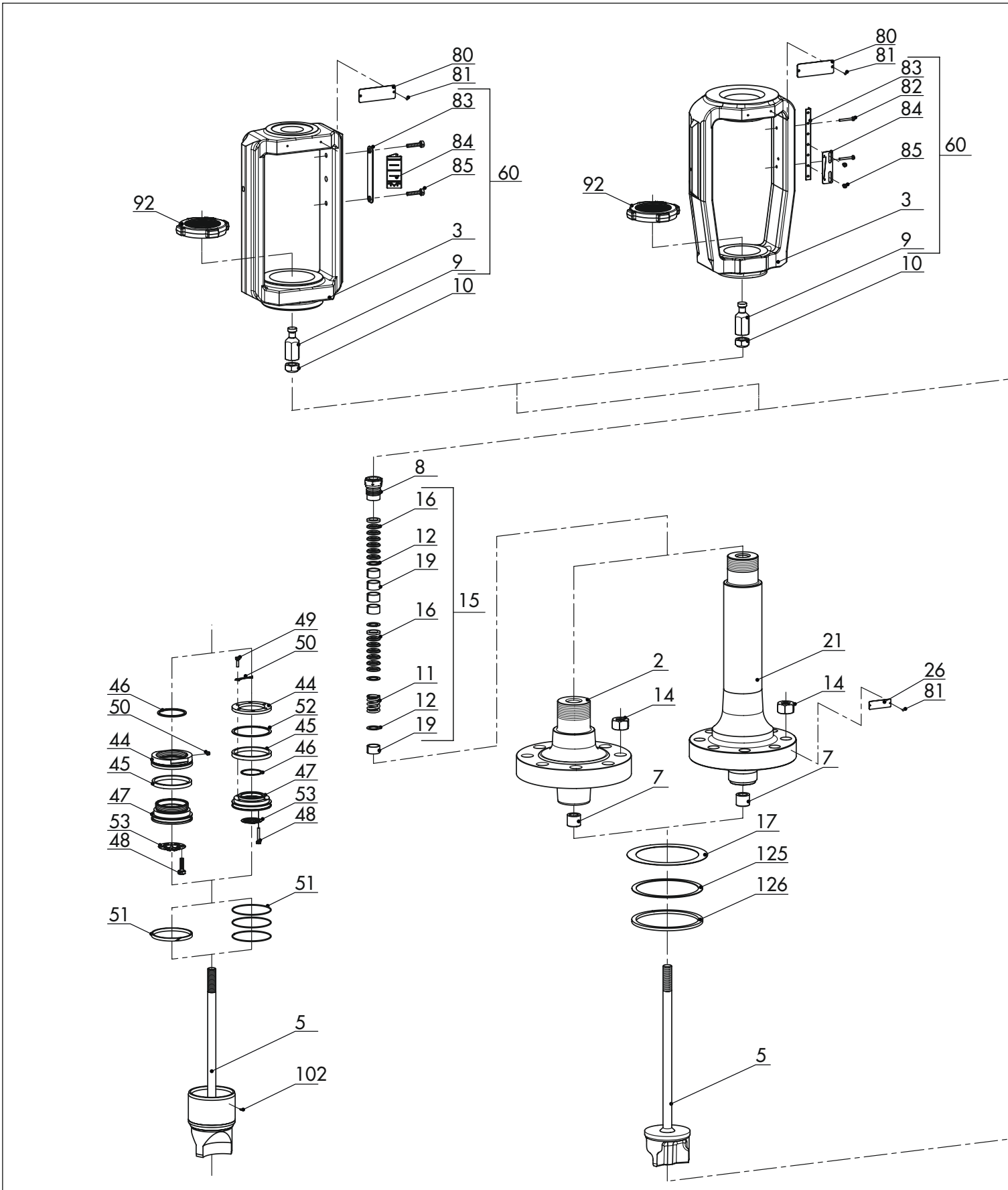

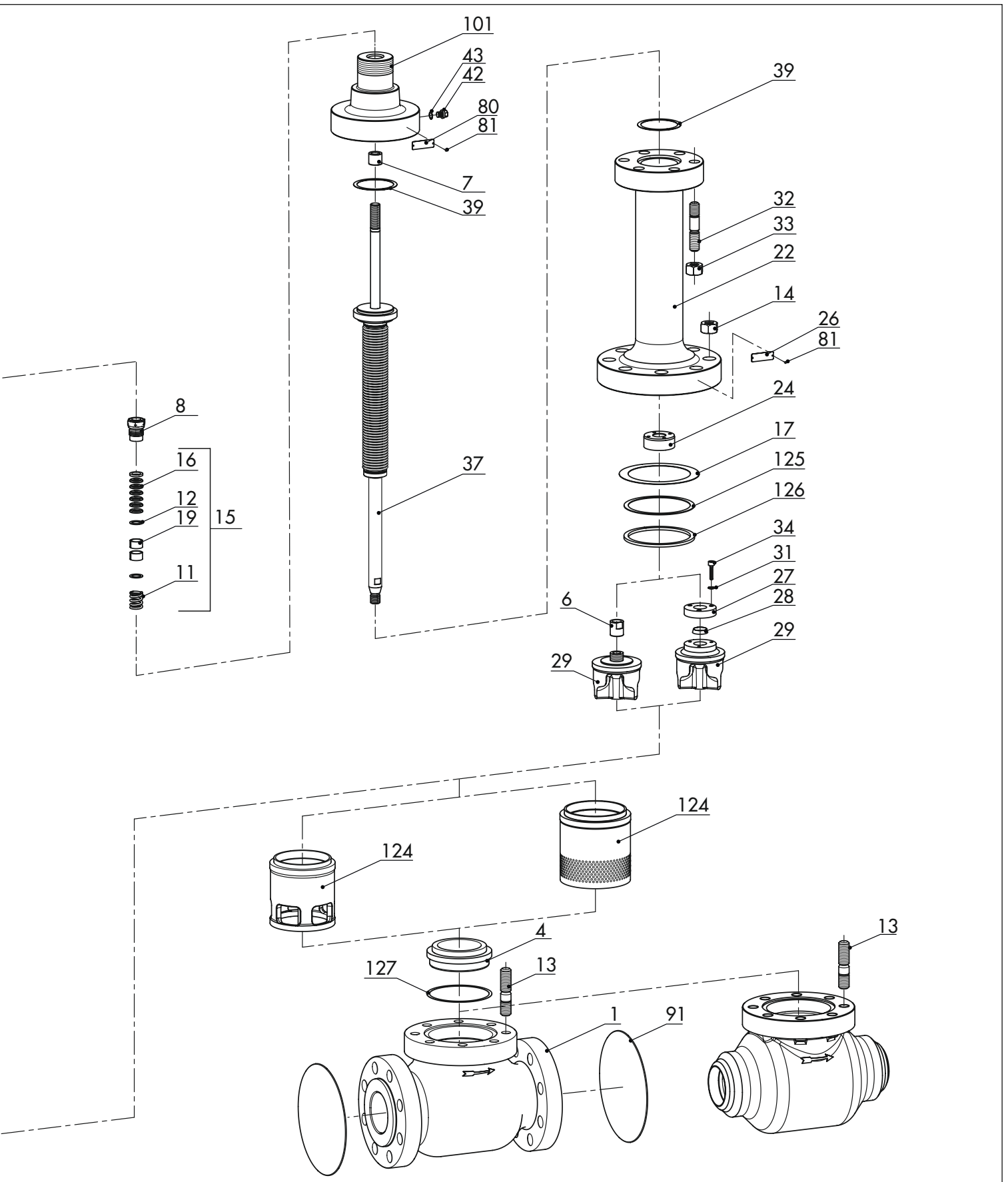

2 Tightening torques

2.1 Tightening torques for connection of body and bonnet/insulating section

NPS	Class	UNC thread	No. of bolts	Tightening torque for body nut (14) in Nm
½ to 1	150	½"-13	4	30
1½		-		
2		⅝"-11	4	70
3		⅝"-11	6	70
4		⅝"-11	6	70
6		-		
8		-		
½ to 1	300 to 600	⅝"-11	4	60
1½		⅝"-11	5	70
2		¾"-10	6	100
3		¾"-10	8	140
4		¾"-10	12	130
6		1"-8	14	280
8		1½"-6	8	1200
½ to 1	900	¾"-10	4	70
1½		¾"-10	8	70
2		1⅛"-7	6	200
3		¾"-10	12	140
4		⅞"-9	12	240
6		1"-8	16	400
8		1½"-6	12	2000

2.2 Tightening torques for connection of bellows seal and bellows seal bonnet

NPS	Class	UNC thread	No. of bolts	Tightening torque for nut (33) in Nm
½ to 1½	150 to 300	⅝"-11	4	42
2 to 4		⅝"-11	6	40
5		¾"-10	6	70
6		1"-8	8	108
8		1"-8	8	108
½ to 1½	600 to 900	⅝"-11	4	80
2 to 4		⅝"-11	6	76
5		¾"-10	6	136
6		1"-8	8	212
8	1"-8	8	212	
½ to 1½	1500	¾"-10	4	154
2 to 3		¾"-10	6	148
½ to 1½	2500	¾"-10	4	178
2 to 3		¾"-10	8	128

3 Lubricant

⚠ WARNING

Damage to health after contact with hazardous substances.

Certain lubricants (e.g. 8150-4008) are classified as hazardous substances. These substances have a special label and a material safety data sheet (MSDS) issued by the manufacturer.

→ Make sure that an MSDS is available for any hazardous substance used. If necessary, contact the manufacturer to obtain an MSDS.

→ Inform operating personnel about the hazardous substances and their correct handling.

3.1 Recommended lubricant

Application	Quantity [g]	Temperature range in °C	Color	Material no. of lubricant
Valves for oxygen service (free of oil and grease)	60	-45 to +200	White	8150-0116
Pneumatic devices (O-rings, guide bearings)	-	-40 to +260	White/transparent	8150-0100
Seat thread, stud bolts, spring compression	100	-180 to +1200	Gray	8150-4010
	250			8150-4008
Plug stem seal	10	-200 to +220	White	8150-4000
	60			8150-4007
	650			8150-0073

3.2 Lubricant sorted by parts and versions

Application	Plug	Threaded bushing	Stem connector and lock nuts	Stud bolt/body nut
Number within drawing (see section 1.2)	5	8	9/10	13/14
Series 290	8150-4000/ 8150-4007/ 8150-0073	8150-4008	8150-4008	8150-4008
Version for oxygen service (cold box)	8150-0116	8150-0116	8150-0116	8150-0116
Application	Packing	Nut and bolt	Plug stem with metal bellows	
Number within drawing (see section 1.2)	15	32/33	37	
Series 290	8150-4000/ 8150-4007/ 8150-0073	8150-4008	8150-4000/ 8150-4007/ 8150-0073	
Version for oxygen service (cold box)	8150-0116	8150-0116	8150-0116	

4 Tools

4.1 Standard tools

No special tools are required to mount and remove the seat, plug and gaskets. The following conventional tools can be used for this purpose:

- Open-end wrench
- Socket wrench
- Torque wrench
- To measure how many gaskets/shims are required: vernier depth gauge, dial gauge with magnet tripod or caliper with depth gauge

4.2 Packing tools

We recommend using the following tools to install and remove the packing:

Packing tool

Valve size NPS	Tool	Material no.	Image
½ to 1½	Packing tool (12 mm plug stem diameter)	1280-3039	
2 to 4	Packing tool (16 mm plug stem diameter)	1280-3038	
6	Packing tool (25 mm plug stem diameter)	1280-3040	
8	Packing tool (40 mm plug stem diameter)	1280-3041	

Packing extractor

Valve size NPS	Tool	Material no.	Image
½ to 1½	Packing extractor	1280-3037	
2 to 20	Packing extractor	1280-3035	
8 to 20	Packing extractor to pull out spacers out of the packing chamber	1280-3036	

Hook wrench for threaded bushing

Valve size NPS	Tool	Material no.	Image
8 and larger	Hook wrench to loosen and tighten the threaded bushing (packing nut)	1280-3000	

Tool for high-temperature packings

Valve size NPS	Tool	Material no.	Image
½ to 1½	Tool (modified threaded bushing), 12 mm plug stem diameter	1280-2007	
2 to 4	Tool (modified threaded bushing), 16 mm plug stem diameter	1280-2006	
6	Tool (modified threaded bushing), 25 mm plug stem diameter	1280-2008	
8	Tool (modified threaded bushing), 40 mm plug stem diameter	1280-2009	



1 Information on Type 3321 Valve

1.1 Technical data

		Type 3321
Image		
Series		V2001
Valve size	DIN	DN 15 to 100
	ANSI	NPS ½ to 4
Associated product documentation	Data sheet	▶ T 8111 (DIN) and ▶ T 8112 (ANSI)
	Mounting and operating instructions	▶ EB 8111/8112

1.2 Parts

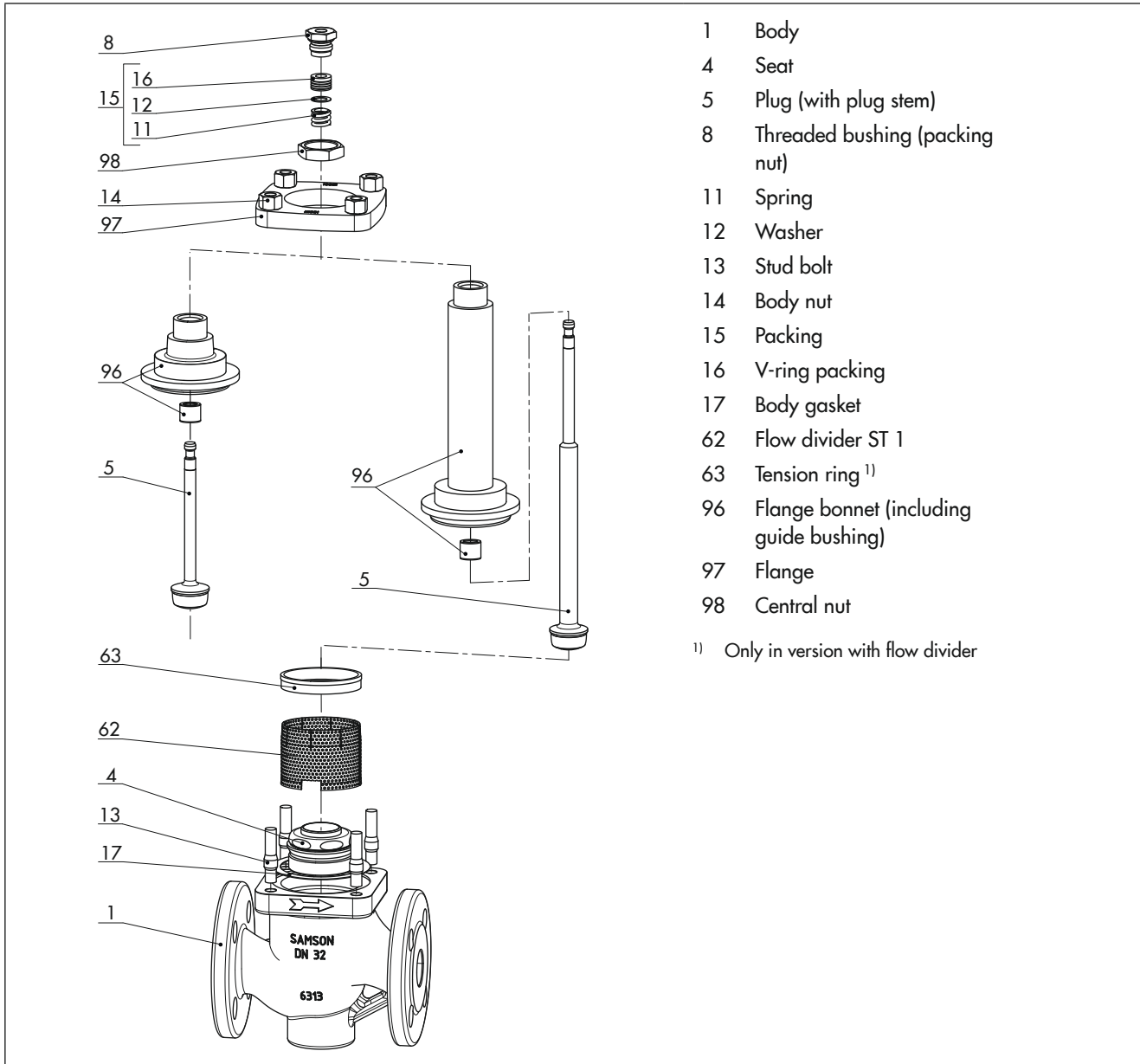

2 Tightening torques

Note concerning the following specifications

- All tightening torques specified in Nm
- Tightening torque tolerance: $\pm 10\%$
- The tightening torques are based on a friction coefficient of 0.06 with a lubricated seat thread and facing.
- After long operating times or long periods or use at temperatures above 250 °C, the breakaway torque may be twice as high as the tightening torque.

2.1 Tightening torques to install the seat

Number of seat within drawing: 4

Valve size			Seats made of 1.4006		Seats made of all other materials	
DN	NPS	Thread	Without torque multiplier	With torque multiplier ¹⁾	Without torque multiplier	With torque multiplier ¹⁾
15 to 25	½ to 1	M32x1.5	3 to 12 mm seat Ø: 120 24 mm seat Ø: 170	– ²⁾	160	– ²⁾
32 to 50	1½ to 2	M58x1.5	500	40	480	38
65 to 80	2½ to 3	M90x1.5 ³⁾	1050	84	900	72
100	4	M110x1.5 ³⁾	1550	124	1250	100



¹⁾ Torque multiplier with gear ratio 1:12.5

²⁾ Only use a torque wrench to tighten the seat; do not use an additional torque multiplier.

³⁾ The seat thread is not required when the body is made of stainless steel.

Special tools

The following tools are additionally required to install and remove the seat:

Valve size		Tool	Material no.	Image
DN	NPS			
32 to 100	1¼ to 4	Torque multiplier SX30, gear ratio 1:12.5, max. 3000 Nm	9932-3808	
32 to 50	1¼ to 2	Torque wrench	9932-3812	
80 to 100	3 to 4	Torque wrench	9932-3814	

2.2 Tightening torques for connection of body and bonnet

Valve size		Tightening torque for body nut (14) in Nm
DN	NPS	
For standard version		
15 to 25	½ to 1	30
32 to 50	1½ to 2	50
65 to 80	2½ to 3	100
100	4	150
For version with insulating section		
15 to 25	½ to 1	50
32 to 50	1½ to 2	50
65 to 80	2½ to 3	160
100	4	160

2.3 Tightening torques for threaded bushing

Valve size		Tightening torque for threaded bushing (8) [Nm]
DN	NPS	
15 to 50	½ to 2	50
65 to 100	2½ to 4	80

2.4 Tightening torques for central nuts

Valve size		Tightening torque for central nut (98) [Nm]
DN	NPS	
15 to 50	½ to 2	150

3 Lubricant

⚠ WARNING

Damage to health after contact with hazardous substances.

Certain lubricants (e.g. 8150-4008) are classified as hazardous substances. These substances have a special label and a material safety data sheet (MSDS) issued by the manufacturer.

→ Make sure that an MSDS is available for any hazardous substance used. If necessary, contact the manufacturer to obtain an MSDS.

→ Inform operating personnel about the hazardous substances and their correct handling.

3.1 Recommended lubricant



Application	Quantity [g]	Temperature range in °C	Color	Material no.
Seat thread, stud bolts	250	-180 to +1200	Gray	8150-4008
Plug stem seal, packing, threaded bushing	10	-200 to +220	White	8150-4000
	60			8150-4007
	650			8150-0073

3.2 Lubricant sorted by parts and versions

Component	Seat	Plug and plug stem	Threaded bushing	Stud bolt	Body nut	Packing
Number within drawing (see section 1.2)	4	5	8	13	14	15
Lubricant	8150-4008	8150-4000/ 8150-4007/ 8150-0073	8150-4008	8150-4008	8150-4008	8150-4000/ 8150-4007/ 8150-0073



4 Tools

4.1 Seat wrenches

Valve size		Tool	Material no.	Image
DN	NPS			
15 to 25	½ to 1	Seat wrench	1280-3030	
32 to 50	1¼ to 2	Seat wrench	1280-3009	
65 to 80	2½ to 3	Seat wrench	9110-2467	
100	4	Seat wrench	9110-2471	

Special tools

The following tools are additionally required to install and remove the seat:

Valve size		Tool	Material no.	Image
DN	NPS			
32 to 100	1¼ to 4	Torque multiplier SX30, gear ratio 1:12.5, max. 3000 Nm	9932-3808	
32 to 50	1¼ to 2	Torque wrench	9932-3812	
80 to 100	3 to 4	Torque wrench	9932-3814	

4.2 Packing extractor

Valve size		Tool	Material no.	Image
DN	NPS			
15 to 40	½ to 1½	Packing extractor	1280-3037	
50 to 500	2 to 20	Packing extractor	1280-3035	



1 Information on Type 3321CT Valve

1.1 Technical data

		Type 3321CT
Image		
Series		V2001
Valve size	DIN	DN 15 to 50
	ANSI	NPS ½ to 2
Associated product documentation	Data sheet	▶ T 8115
	Mounting and operating instructions	▶ EB 8115

1.2 Parts

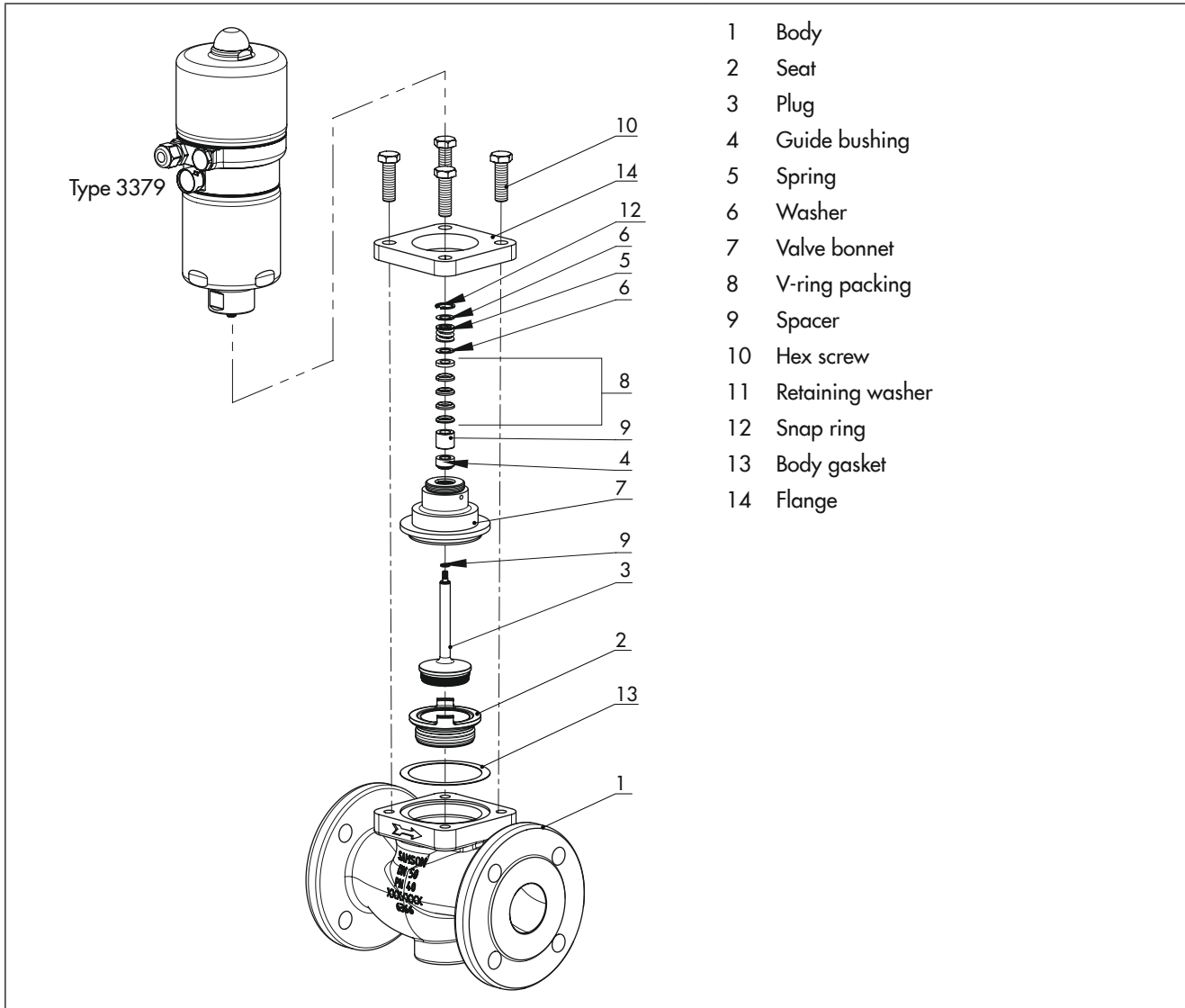

2 Tightening torques

Note concerning the following specifications

- All tightening torques specified in Nm
- Tightening torque tolerance: $\pm 10\%$
- The tightening torques are based on a friction coefficient of 0.06 with a lubricated seat thread and facing.
- After long operating times or long periods or use at temperatures above 250 °C, the breakaway torque may be twice as high as the tightening torque.

2.1 Tightening torques to install the seat

Number of seat within drawing: 2



Valve size			Seats made of 1.4004	
DN	NPS	Thread	Without torque multiplier	With torque multiplier ¹⁾
15 to 25	½ to 1	M32x1.5	3 to 12 mm seat Ø: 120 24 mm seat Ø: 170	– ²⁾
32 to 50	1½ to 2	M58x1.5	500	40

¹⁾ Torque multiplier with gear ratio 1:12.5

²⁾ Only use a torque wrench to tighten the seat; do not use an additional torque multiplier.

Special tools

The following tools are additionally required to install and remove the seat:

Valve size		Tool	Material no.	Image
DN	NPS			
32 to 50	1¼ to 2	Torque multiplier SX30, gear ratio 1:12.5, max. 3000 Nm	9932-3808	
32 to 50	1¼ to 2	Torque wrench	9932-3812	

2.2 Tightening torques for connection of body and bonnet

Valve size		Tightening torque for body nut (10) in Nm
DN	NPS	
15 to 25	½ to 1	30
32 to 50	1½ to 2	50

2.3 Tightening torques for connection of plug stem and actuator stems

Valve size		Tightening torque for plug stem (3) in Nm
DN	NPS	
15 to 50	½ to 2	4

2.4 Tightening torques for connection of bonnet and Type 3379 Actuator

Valve size		Tightening torque for valve bonnet (7) in Nm
DN	NPS	
15 to 50	½ to 2	4

3 Lubricant

⚠ WARNING

Damage to health after contact with hazardous substances.

Certain lubricants (e.g. 8150-4008) are classified as hazardous substances. These substances have a special label and a material safety data sheet (MSDS) issued by the manufacturer.

→ Make sure that an MSDS is available for any hazardous substance used. If necessary, contact the manufacturer to obtain an MSDS.

→ Inform operating personnel about the hazardous substances and their correct handling.

3.1 Recommended lubricant



Application	Quantity [g]	Temperature range in °C	Color	Material no.
Seat thread, valve bonnet	250	-180 to +1200	Gray	8150-4008
Packing, body nuts	10	-200 to +220	White	8150-4000
	60			8150-4007
	650			8150-0073

3.2 Lubricant sorted by parts

Component	Seat	Valve bonnet	Body nut	Packing
Number within drawing (see section 1.2)	2	7	14	15
Lubricant	8150-4008	8150-4008	8150-4000/ 8150-4007/ 8150-0073	8150-4000/ 8150-4007/ 8150-0073



4 Tools

4.1 Seat wrenches

Valve size		Tool	Material no.	Image
DN	NPS			
15 to 25	½ to 1	Seat wrench	1280-3030	
32 to 50	1¼ to 2	Seat wrench	1280-3009	

Special tools

The following tools are additionally required to install and remove the seat:

Valve size		Tool	Material no.	Image
DN	NPS			
32 to 50	1¼ to 4	Torque multiplier SX30, gear ratio 1:12.5, max. 3000 Nm	9932-3808	
32 to 50	1¼ to 2	Torque wrench	9932-3812	

4.2 Packing extractor

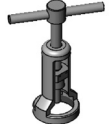
Valve size		Tool	Material no.	Image
DN	NPS			
15 to 40	½ to 1½	Packing extractor	1280-3037	
50 to 500	2 to 20	Packing extractor	1280-3035	
15 to 50	½ to 4	Assembly tool for packing	1281-0094	



1 Information on Type 3323 Valve

1.1 Technical data

		Type 3323
Image		
Valve size	DIN	DN 15 to 100
	ANSI	NPS ½ to 4
Associated product documentation	Data sheet	▶ T 8113 (DIN) and ▶ T 8114 (ANSI)
	Mounting and operating instructions	▶ EB 8113/8114

1.2 Parts

Parts of the valve assembly are shown on the next page.

DN 15 to 50/NPS ½ to 2		DN 65 to 100/NPS 2½ to 4	
2	Plug stem	1	Body
7	Guide bushing	2	Valve bonnet/insulating section
17	Plug	4	Top seat
20	Body	5	Top plug
22	Nameplate	7	Guide bushing
27	Valve bonnet/insulating section	8	Threaded bushing (packing nut)
34	Flange	11	Spring
40	Spacer	12	Washer
41	Spacer	13	Stud
46	Body gasket	14	Body nut
51	Stud	15	Packing
52	Body nut	16	V-ring packing
121	Hex nut (self-locking)	17	Body gasket
122	Retaining washer	36	Plug stem
123	Washer	40	Hex nut (self-locking)
131	Threaded bushing (packing nut)	75	Spacer
132	Washer	76	Spacer
133	Spring	80	Nameplate
134	V-ring packing	81	Grooved pin
135	Central nut	141	Bottom seat
161	Top seat	192	Washer
162	Bottom seat	199	Bottom plug

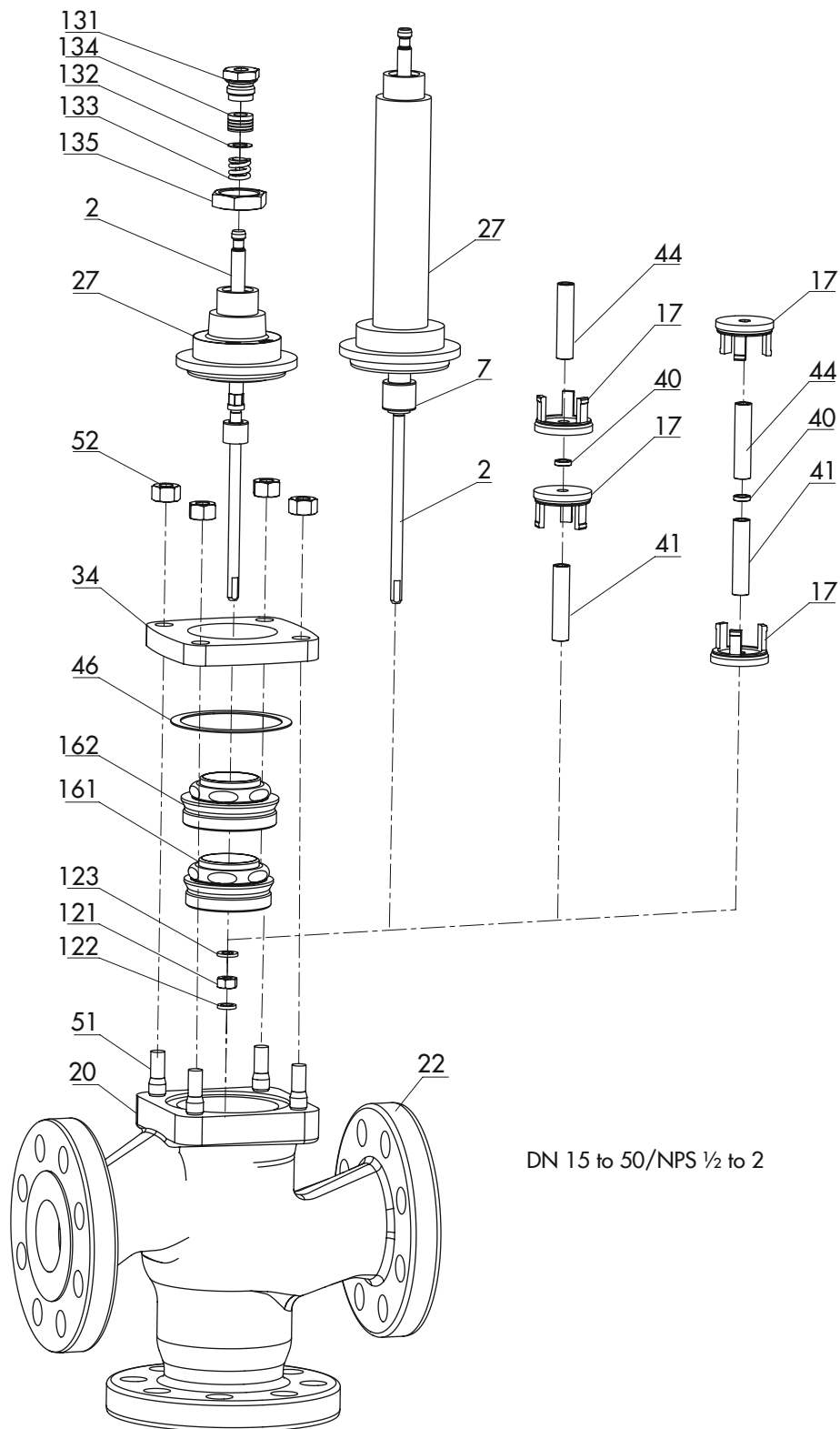

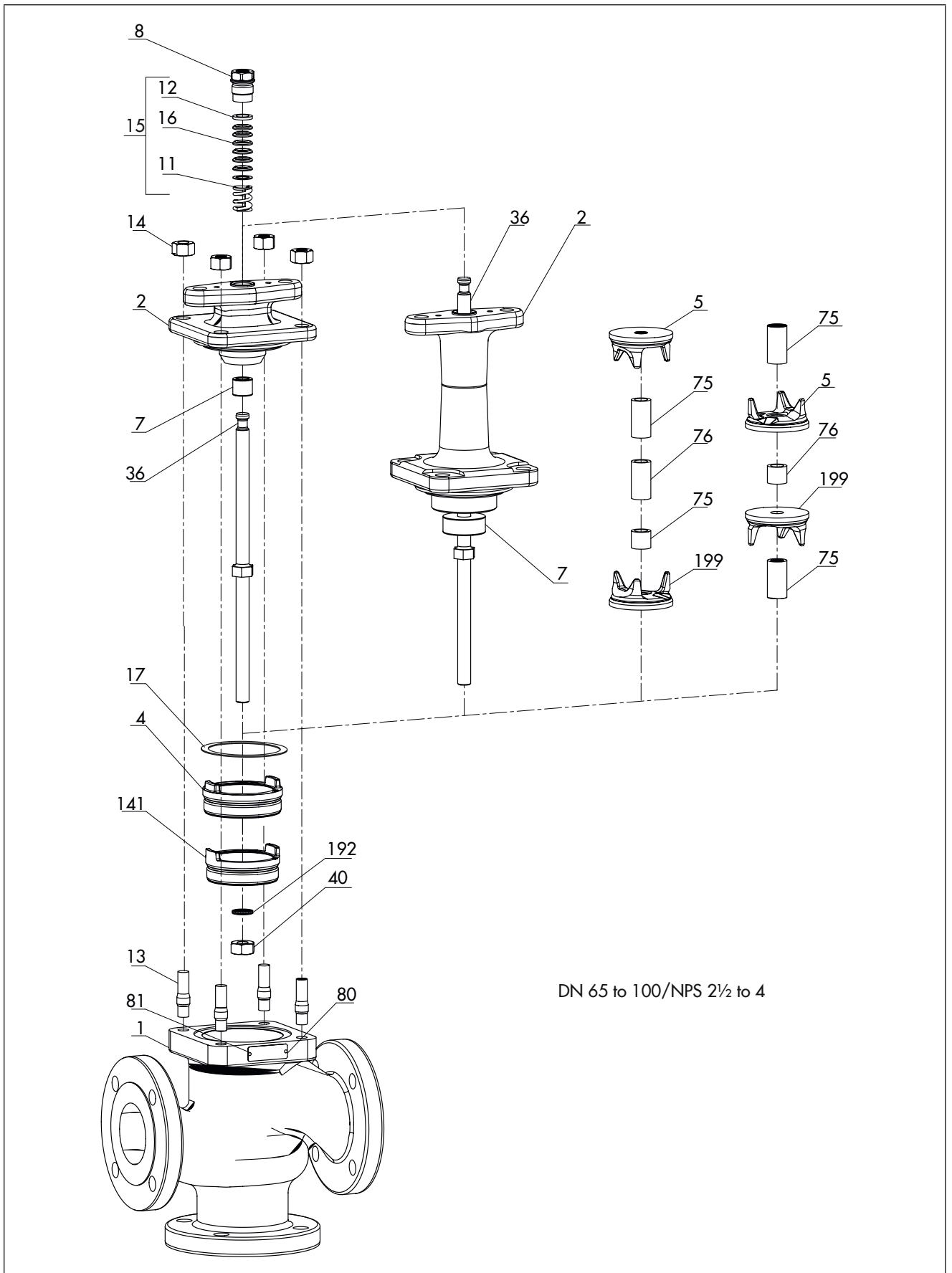

2 Tightening torques

2.1 Tightening torques to install the seat

2.1.1 Top seat

Number of top seat within drawing: DN 15 to 50: 162 · DN 65 to 100: 4

Valve size		Seats made of 1.4006		Seats made of all other materials	
DN	NPS	Without torque multiplier	With torque multiplier ¹⁾	Without torque multiplier	With torque multiplier ¹⁾
15 and 25	½ and 1	120	– ²⁾	120	– ²⁾
32 to 50	1½ and 2	500	40	500	40
65 and 80	2½ and 3	1100	88	950	76
100	4	1750	140	1400	112

¹⁾ Torque multiplier with gear ratio 1:12.5

²⁾ Only use a torque wrench to tighten the seat; do not use an additional torque multiplier.

2.1.2 Bottom seat

Number of bottom seat within drawing: DN 15 to 50: 161 · DN 65 to 100: 141



Valve size		Seats made of 1.4006		Seats made of all other materials	
DN	NPS	Without torque multiplier	With torque multiplier ¹⁾	Without torque multiplier	With torque multiplier ¹⁾
15 and 25	½ and 1	120	– ²⁾	120	– ²⁾
32 to 50	1½ and 2	500	40	500	40
65 and 80	2½ and 3	1025	82	880	70
100	4	1650	132	1320	106

¹⁾ Torque multiplier with gear ratio 1:12.5

²⁾ Only use a torque wrench to tighten the seat; do not use an additional torque multiplier.

Special tools

The following tools are additionally required to install and remove the seat:

Valve size		Tool	Material no.	Image
DN	NPS			
32 to 100	1½ to 4	Torque multiplier SX30, gear ratio 1:12.5, max. 3000 Nm	9932-3808	
32 to 50	1½ and 2	Torque wrench	9932-3812	
80 and 100	3 and 4	Torque wrench	9932-3814	

2.2 Tightening torques for connection of body and bonnet

Valve size		Tightening torque for body nut (52 and 14) in Nm
DN	NPS	
15 and 25	½ and 1	30
32 to 50	1½ and 2	50
65 and 80	2½ and 3	100
100	4	150

2.3 Tightening torques for threaded bushing

Valve size		Tightening torque for threaded bushing (131 and 8) in Nm
DN	NPS	
15 to 100	½ to 4	20

2.4 Tightening torques for the hex nut at the plug stem end

Valve size		Tightening torque for hex nut (121 and 40) in Nm
DN	NPS	
15 and 25	½ and 1	15
32 to 50	1½ and 2	15
65 and 80	2½ and 3	100
100	4	100

2.5 Tightening torques for central nuts

Valve size		Tightening torque for central nut (135) [Nm]
DN	NPS	
15 to 50	½ to 2	150

3 Lubricant

⚠ WARNING

Damage to health after contact with hazardous substances.

Certain lubricants (e.g. 8150-4008) are classified as hazardous substances. These substances have a special label and a material safety data sheet (MSDS) issued by the manufacturer.

→ Make sure that an MSDS is available for any hazardous substance used. If necessary, contact the manufacturer to obtain an MSDS.

→ Inform operating personnel about the hazardous substances and their correct handling.

3.1 Recommended lubricant



Application	Quantity [g]	Temperature range in °C	Color	Material no.
Seat thread, stud bolts	250	-180 to +1200	Gray	8150-4008
Plug stem seal, packing, threaded bushing	10	-200 to +220	White	8150-4000
	60			8150-4007
	650			8150-0073

3.2 Lubricant sorted by parts and versions

Component	Seat	Plug and plug stem	Threaded bushing	Body nut	Packing	Hex nut (self-locking)	
Item no.	DN 15 to 50/ NPS ½ to 2	161, 162	17, 2	131	52	134	121
	DN 65 to 100/ NPS 2½ to 4	4, 141	5, 199, 36	8	14	15	40
Lubricant	8150-4008	8150-4000/ 8150-4007/ 8150-0073	8150-4008	8150-4008	8150-4000/ 8150-4007/ 8150-0073	8150-4008	



4 Tools

4.1 Seat wrenches







Valve size		Tool	Material no.	Image
DN	NPS			
15 and 25	½ and 1	Seat wrench	1280-3010	
32 to 50	1½ and 2	Seat wrench	1280-3011	
65 and 80	2½ and 3	Seat wrench	1280-0305	
100	4	Seat wrench	1280-0405	

Special tools

The following tools are additionally required to install and remove the seat:

Valve size		Tool	Material no.	Image
DN	NPS			
32 to 100	1½ to 4	Torque multiplier SX30, gear ratio 1:12.5, max. 3000 Nm	9932-3808	
15 and 25	½ and 1	Torque wrench	9932-3812	
32 to 100	1½ to 4	Torque wrench	9932-3814	

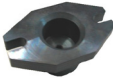
4.2 Assembly tools

Valve size		Tool	Material no.	Image
DN	NPS			
15 and 25	½ and 1	Tool to hold the plug stem stationary at the hexagonal part to undo or tighten the bolt Consisting of:		
		Flange for plug stem	1280-3057	
		Socket to fasten the nut, toothed lock washers or shim	1280-3059	
32 to 50	1½ and 2	Tool to hold the plug stem stationary at the hexagonal part to undo or tighten the bolt Consisting of:		
		Flange for plug stem	1280-3058	
		Socket to fasten the nut, toothed lock washers or shim	1280-3059	

1 Information on Type 3349 Valve

1.1 Technical data

		Type 3349
Image		
Valve size (standard)	DIN	DN 15 to 50
	ANSI	NPS ½ to 2
Valve size (micro-flow valve)	DIN	DN 8 to 25
	ANSI	NPS ¼ to 1 (version for Type 3271/Type 3277) NPS ⅜ to 1 (version for Type 3379)
Associated product documentation	Data sheet	▶ T 8048-2 ▶ T 8048-3
	Mounting and operating instructions	▶ EB 8048-2/-3

1.2 Note on Type 3349

The Type 3349 Angle Valve is designed for aseptic applications in the food and pharmaceutical industries according to DIN or ANSI standards. Special standards and regulators apply in these industries, which are essential for the correct and safe handling of products. Contact SAMSON's After-sales Service department if you have any questions.

1.3 Note on actuators

The Type 3349 Angle Valve can be combined with either a Type 3271, Type 3277 or Type 3379 Pneumatic Actuator. The valve construction differs depending on the version. Therefore, a difference is made in following based on the actuator mounted on the valve.

- Tightening torques, lubricants and tools for the Type 3271 and Type 3277 Pneumatic Actuators are listed in the section on Type 3271 and Type 3277 Actuators in this document.
- Tightening torques, lubricants and tools for the Type 3379 Pneumatic Actuator are listed in ▶ EB 8315.

1.4 Parts

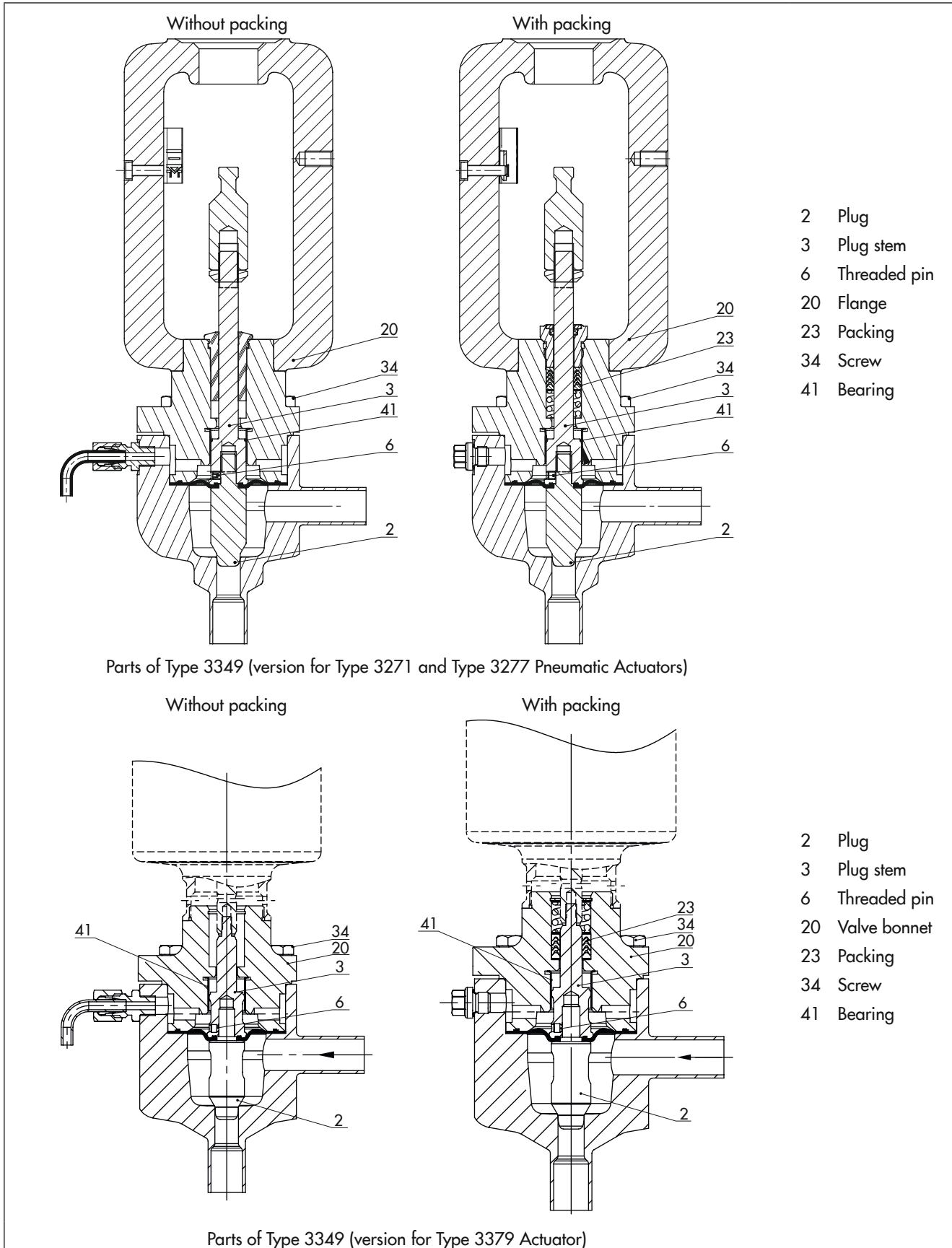

2 Tightening torques

2.1 Tightening torques for Type 3349 with Type 3271 or Type 3277 Actuator

i Note

Tightening torques for the Type 3271 and Type 3277 Pneumatic Actuators are listed in the section on Type 3271 and Type 3277 Actuators in this document.

2.1.1 Tightening torques for connection of plug and plug stem

Valve size		Tightening torque for plug (2) and plug stem (3) in Nm
DN	NPS	
8 to 25 (micro-flow valve)	¼ to 1 (micro-flow valve)	4
15 to 25	½ to 1	16
32 to 65	1¼ to 2½	135
80 and 100	3 and 4	200

2.1.2 Tightening torques for connection of body and valve bonnet

! NOTICE

Risk of damage to the body screws due to excessively high tightening torques.

Older valve versions have body screws (34), which are no longer suitable for the specified tightening torques.

→ Make sure that the new screws are used for all versions. Contact SAMSON's After-sales Service.

Valve size		Tightening torque for screw (34) in Nm
DN	NPS	
8 to 25 (micro-flow valve)	¼ to 1 (micro-flow valve)	7
15 to 25	½ to 1	16
32 to 65	1¼ to 2½	40
80 and 100	3 and 4	135

2.2 Tightening torques for Type 3349 with Type 3379 Actuator

2.2.1 Tightening torques for connection of plug and plug stem

Valve size		Tightening torque for plug (2)/plug stem (3) in Nm
DN	NPS	
8 to 25 (micro-flow valve)	⅜ to 1 (micro-flow valve)	4
15 to 25	½ to 1	16
32 to 50	1¼ to 2	135

Lubricant

2.2.2 Tightening torques for connection of body and valve bonnet

Valve size		Tightening torque for screw (34) in Nm
DN	NPS	
8 to 25 (micro-flow valve)	3/8 to 1 (micro-flow valve)	7
15 to 25	1/2 to 1	16
32 to 50	1 1/4 to 2	40

2.2.3 Tightening torques for connection of actuator stem and plug stem

Valve size		Tightening torque for actuator stem and plug stem (3) in Nm
DN	NPS	
8 to 50	1/4 to 2	4

3 Lubricant

⚠ WARNING

Damage to health after contact with hazardous substances.

Certain lubricants (e.g. 8150-4008) are classified as hazardous substances. These substances have a special label and a material safety data sheet (MSDS) issued by the manufacturer.

- ➔ Make sure that an MSDS is available for any hazardous substance used. If necessary, contact the manufacturer to obtain an MSDS.
- ➔ Inform operating personnel about the hazardous substances and their correct handling.

3.1 Recommended lubricant

Application	Temperature range in °C	Color	Material no. of lubricant
Valves for food processing	-50 to +150	White	8150-9002

3.2 Lubricant sorted by parts and versions

Application	Plug	Plug stem	Threaded pin	Bearing
Number within drawing (see section 1.4)	2	3	6	41
Standard version	8150-9002	8150-9002	8150-9002	8150-9002
Micro-flow valve version	8150-9002	8150-9002	–	8150-9002
Application	Packing	Flange/valve bonnet	Screw	
Number within drawing (see section 1.4)	23	20	34	
Standard version	8150-9002	8150-9002	–	
Micro-flow valve version	8150-9002	–	–	

4 Tools

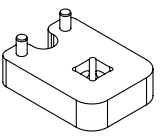
Valve size		Tool	Connections		Material no.	Image
DN	NPS					
8 to 25 (micro-flow valve)	¼ to 1 (micro-flow valve)	Set of tools consisting of clamping rings to clamp the plug stem in a vise	-	-	1281-0035	
15 to 25	½ to 1					
32 to 50	1¼ to 2					
32 to 65	1¼ to 2½	Special wrench for plug stem	½"	■	1281-0092	
80 and 100	3 and 4	Special wrench for plug stem	½"	■	1281-0093	

Special tools

The following tools are additionally required to mount the plug:

Valve size		Tool	Reference ¹⁾
DN	NPS		
32 to 100	1¼ to 4	ISI torque wrench, 20 to 100 Nm	3345-2

¹⁾ ISI order number (not a SAMSON material no.)

1 Information on Type 3310 Valve

1.1 Technical data

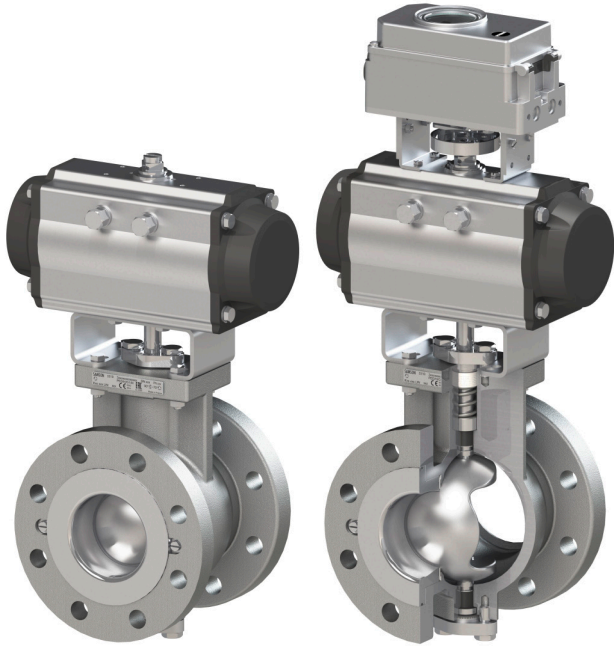
		Type 3310
Image		
Valve size	DIN	DN 25 to 300
	ANSI	NPS 1 to 12
Associated product documentation	Data sheet	▶ T 8222-1
	Mounting and operating instructions	▶ EB 8222-1

1.2 Note on Type 3310

The Type 3310 Segmented Ball Valve is suitable for liquids, vapors and gases. The edition 2020 is a reengineered version of the original valve model.

1.3 Note on actuators

The Type 3310 Segmented Ball Valve can be combined with an AIR TORQUE Type SRP/DAP Pneumatic Rotary Actuator or SAMSON Type 3278 Pneumatic Rotary Actuator.

1.4 Parts

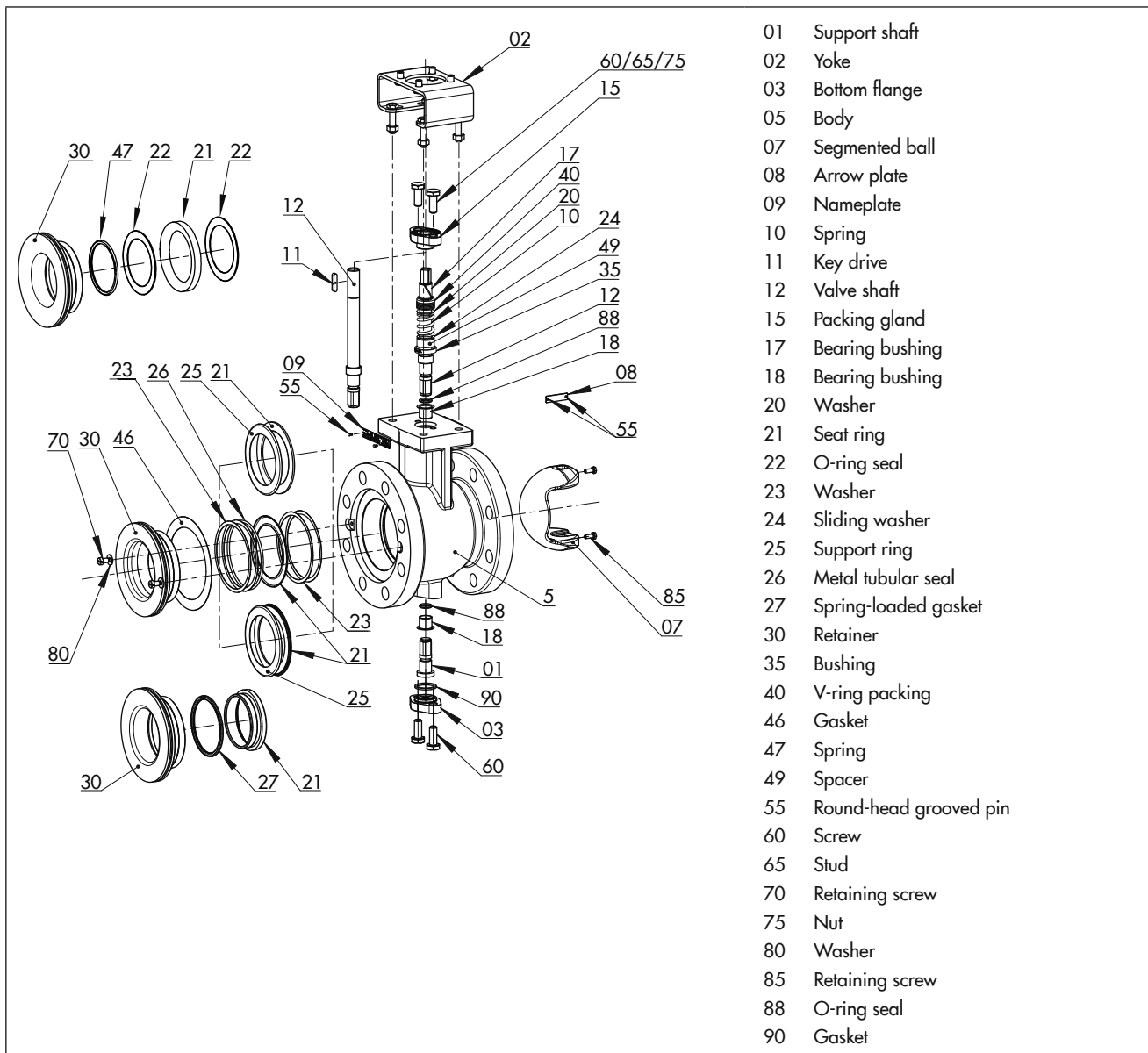

2 Tightening torques

Note concerning the following specifications

- All tightening torques specified in Nm
- Use a torque wrench to apply and check the tightening torques.

2.1 Tightening torques for connection of valve and pipeline

NOTICE

Risk of valve malfunction due to incorrect tightening torques.

The bolted joint connection between the valve and pipeline exerts pressure on the retainer in the valve. In turn, this exerts pressure on the seat ring and helps seal the ball.

➔ Observe the specified tightening torques to ensure the valve functions properly.

2.1.1 ANSI version

Valve size	NPS	1		1½		2		3		4		6		8		10		12	
Pressure rating	Class	150	300	150	300	150	300	150	300	150	300	150	300	150	300	150	300	150	300
Flange bolts Re _{min} = 640 MPa		4 x ½"	4 x ⅝"	4 x ½"	4 x ¾"	4 x ⅝"	8 x ⅝"	4 x ⅝"	8 x ¾"	8 x ⅝"	8 x ¾"	8 x ¾"	12 x ¾"	8 x ¾"	12 x ⅞"	12 x ⅞"	16 x 1"	12 x ⅞"	16 x 1 ⅛"
Tightening torque		35	45	45	65	90	45	125	65	80	80	125	80	165	125	155	135	155	125

2.1.2 DIN version

Valve size	DN	25		40		50		80		100		150		200				250				300			
Pressure rating	PN	10/40	10/40	10/40	10/16	25/40	10/16	25/40	10/16	25/40	10/16	25/40	10	16	25	40	10	16	25	40	10	16	25	40	
Flange bolts Re _{min} = 640 MPa		4 x M12	4 x M16	4 x M16	8 x M16	8 x M16	8 x M16	8 x M20	8 x M20	8 x M24	8 x M20	12 x M20	12 x M24	12 x M27	12 x M20	12 x M24	12 x M27	12 x M30	12 x M20	12 x M24	16 x M27	16 x M30			
Tightening torque		40	55	75	55	55	70	85	125	150	165	110	135	150	140	165	185	205	140	165	140	165			

2.2 Tightening torques for retaining screws (85) on the segmented ball (07)

Valve size	NPS	1		1½		2		3		4		6		8		10		12	
	DN	25		40		50		80		100		150		200		250		300	
Screw size		M3x0.5				M4x0.7		M5x0.8		M6x1				M8x1.25					
Material		1.4404/316L																	
Tightening torque		1				1.5		3		5				12					

2.3 Tightening torques for the screws (60 or 65/75) on packing gland (15)

Valve size	NPS	1		1½		2		3		4		6		8		10		12	
	DN	25		40		50		80		100		150		200		250		300	
Screw size		⅜-16UNC-2A						⅜-16UNC-2A						½-13UNC-2A					
Material		1.4401/1.4404/A193/A320 B8M Cl.1																	
Tightening torque		35						35						60					

3 Lubricant

⚠ WARNING

Damage to health after contact with hazardous substances.

Certain lubricants (e.g. 8150-0111) are classified as hazardous substances. These substances have a special label and a material safety data sheet (MSDS) issued by the manufacturer.

→ Make sure that an MSDS is available for any hazardous substance used. If necessary, contact the manufacturer to obtain an MSDS.

→ Inform operating personnel about the hazardous substances and their correct handling.



3.1 Recommended lubricant (standard version)

Application	Trade name	Temperature range in °C	Color	Material no.
Chemical-resistant, high-temperature grease ¹⁾	Gleitmo® 591	-25 to +260	White	8150-0111



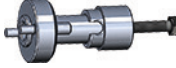

¹⁾ Components that are to be lubricated and tools used for lubrication must be free of oil and grease.

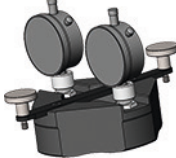
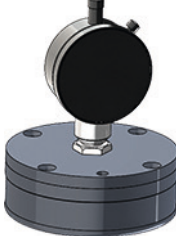
4 Tools

4.1 Assembly tools

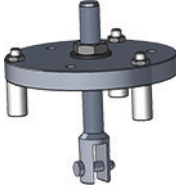
Valve size	NPS	1	1½	2	3	4	6	8	10	12	Image
	DN	25	40	50	80	100	150	200	250	300	
Tool		Material number									Image
Press tool for support shaft (01)		1281-0080	1281-0081		1281-0103	1281-0082		1281-0083			
Press tool for valve shaft (12)	Shaft end with square drive	1281-0097			1281-0098	1281-0099		1281-0100			
	Shaft end with key drive	1281-0101				1281-0102			-		
Centering tool		1281-0072	1281-0079	1281-0073	1281-0074	1281-0075	1281-0076	1281-0077	1281-0078		
Measuring tool for centering		1281-0084	1281-0085	1281-0086	1281-0087	1281-0088	1281-0089	1281-0090	1281-0091	1281-0125	
Master tool		1281-0117	1281-0118	1281-0119	1281-0120	1281-0121	1281-0122	1281-0123	1281-0124		

4.2 Tools for disassembly

Valve size	NPS	1	1½	2	3	4	6	8	10	12	Image
	DN	25	40	50	80	100	150	200	250	300	
Tool		Material number									Image
Bracket		1281-0011	1281-0012	1281-0013	1281-0014	1281-0015	1281-0016	1281-0017	1281-0018		
Extraction tool for retainer (30)	Flange	1281-0007		1281-0008		1281-0009		1281-0010		1281-0126	
		1281-0110				1281-0111		1281-0112			
Extraction tool for support shaft (01)		1281-0110				1281-0111		1281-0112			
Extraction tool for valve shaft (12)		1281-0104	1281-0105	1281-0106	1281-0107	1281-0108		1281-0109			

1 Information on Type 3510 Valve

1.1 Technical data

		Type 3510
Image		
Valve size	DIN	DN 15 to 25
	ANSI	NPS ½ to 1
Associated product documentation	Data sheet	▶ T 8091 and ▶ T 8091-1
	Mounting and operating instructions	▶ EB 8091 and ▶ EB 8091-1

1.2 Note on replacing the trim

i Note

Different seat threads (M10x1 and M16x1) are assigned to the K_{VS} ranges 0.0001 to 0.4 and 0.63 to 1.6. Therefore, the trims are only interchangeable in the same valve size within the specified range.

! NOTICE

Incorrect control performance due to a combination of trim parts that do not match each other.

The trim parts (seat, plug, anti-rotation fixture and body gasket) are matched to exactly fit each other. The trim parts are delivered together and marked accordingly (see associated valve documentation ▶ EB 8091 and ▶ EB 8091-1).

→ Only install matching trim parts.

1.3 Parts

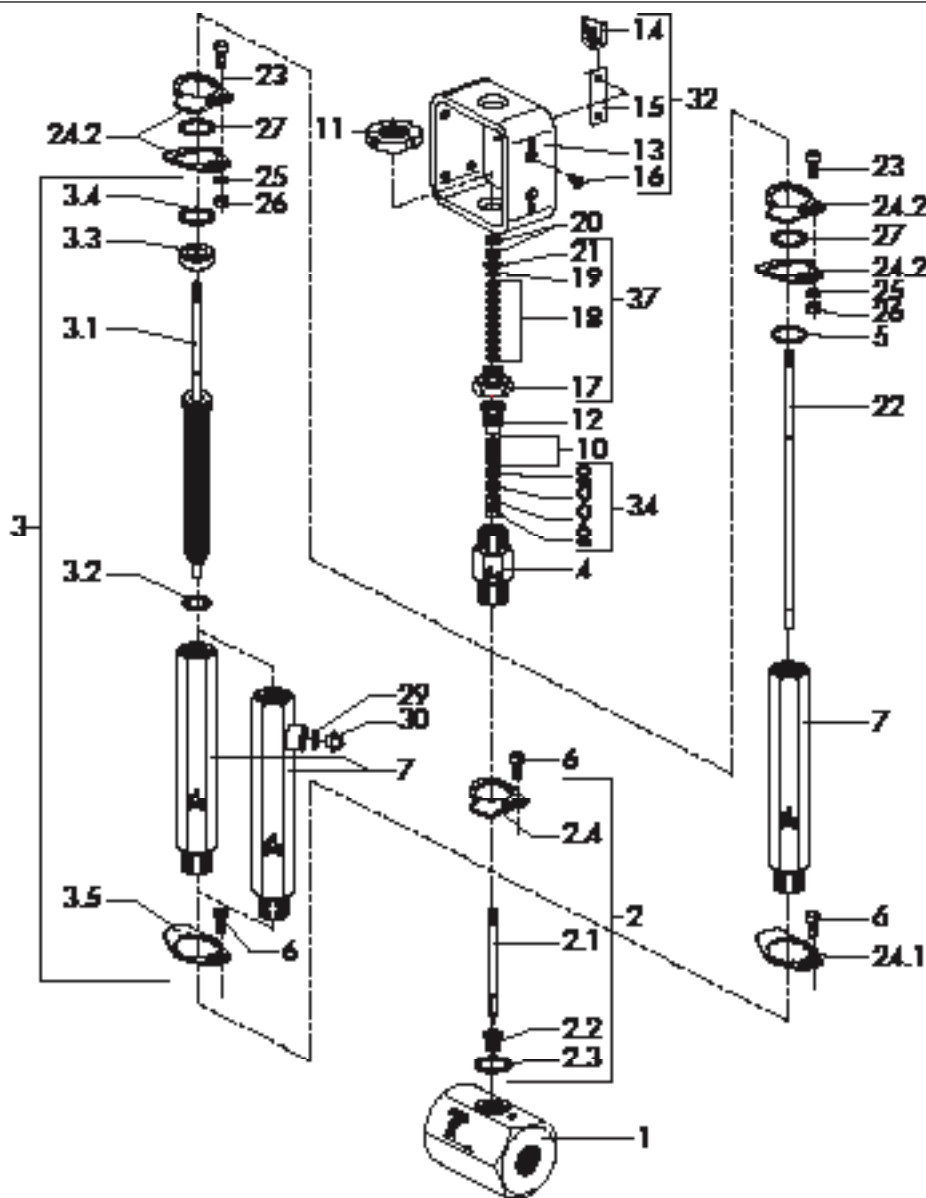

- | | | |
|----------------------------------|-----------------------------------|--|
| 1 Body | 7 Bellows seal/insulating section | 22 Plug stem extension |
| 2 Trim | 8 Seal | 23 Cap screw |
| 2.1 Plug with plug stem | 9 Seal | 24.1 Bottom anti-rotation fixture |
| 2.2 Seat | 10 Packing washer | 24.2 Top anti-rotation fixture (two-piece) |
| 2.3 Body gasket | 11 Slotted round nut | 25 Washer |
| 2.4 Anti-rotation fixture | 12 Threaded bushing (packing nut) | 26 Hex nut |
| 3 Bellows (assembly) | 13 Yoke | 27 Washer |
| 3.1 Plug stem with metal bellows | 14 Travel indicator scale | 29 Seal for test connection |
| 3.2 Seal | 15 Retaining plate | 30 Screw plug |
| 3.3 Bellows nut | 16 Countersunk screw | 32 Yoke (ready mounted) |
| 3.4 Seal (on intermediate piece) | 17 Bearing sleeve | 34 Packing |
| 3.5 Bottom anti-rotation fixture | 18 Disk spring | 37 Lower part of the stem connector (assembly) |
| 4 Intermediate piece | 19 Packing washer | |
| 5 Seal | 20 Hex nut | |
| 6 Cap screw | 21 Snap ring | |

2 Tightening torques

Note concerning the following specifications

- All tightening torques specified in Nm
- Tightening torque tolerance: $\pm 10\%$
- The tightening torques are based on a friction coefficient of 0.06 with a lubricated seat thread and facing.
- After long operating times or long periods or use at temperatures above 250 °C, the breakaway torque may be twice as high as the tightening torque.

2.1 Tightening torques to install the seat

Valve size		Tightening torque for seat (2.2) [Nm]
DN	NPS	
15 to 25	½ to 1	20

2.2 Tightening torques for threaded bushing

Valve size		Tightening torque for threaded bushing (12) [Nm]
DN	NPS	
15 to 25	½ to 1	4

2.3 Tightening torques for intermediate piece

Valve size		Tightening torque for intermediate piece (4) [Nm]
DN	NPS	
15 to 25	½ to 1	120

2.4 Tightening torques for bottom slotted nut

Valve size		Tightening torque for bottom slotted nut (11) in Nm
DN	NPS	
15 to 25	½ to 1	100

2.5 Tightening torques for top slotted nut (ring nut)

i Note

The top slotted nut (ring nut) is used to attach the SAMSON Type 3271 or Type 3277 Actuator. This nut is not shown in the exploded diagram in section 1.3.

Valve size		Tightening torque for top slotted nut (ring nut) [Nm]
DN	NPS	
15 to 25	½ to 1	100

2.6 Tightening torques for hex nuts on the tip of the plug stem

Valve size		Tightening torque for hex nuts (20) [Nm]
DN	NPS	
15 to 25	½ to 1	7

2.7 Tightening torques for bellows

Valve size		Tightening torque for bellows (3) [Nm]
DN	NPS	
15 to 25	½ to 1	90

Tightening torques

2.8 Tightening torques for bellows seal/insulating section on the body

Valve size		Tightening torque for bellows seal/insulating section (7) [Nm]
DN	NPS	
15 to 25	½ to 1	120

3 Lubricant

⚠ WARNING

Damage to health after contact with hazardous substances.

Certain lubricants (e.g. 8150-4008) are classified as hazardous substances. These substances have a special label and a material safety data sheet (MSDS) issued by the manufacturer.

→ Make sure that an MSDS is available for any hazardous substance used. If necessary, contact the manufacturer to obtain an MSDS.

→ Inform operating personnel about the hazardous substances and their correct handling.

3.1 Recommended lubricant

Application	Quantity [g]	Temperature range in °C	Color	Material no. of lubricant
Valves for oxygen service (free of oil and grease)	60	-60 to +250	White	8150-0116
Plug stem seal	10	-200 to +220	White	8150-4000
	60			8150-4007
	650			8150-0073



3.2 Lubricant sorted by parts

Application	Plug ¹⁾	Seat	Bellows	Intermediate piece
Number within drawing (see section 1.3)	2.1	2.2	3	4
Type 3510	8150-4000/ 8150-4007/ 8150-0073	8150-4000/ 8150-4007/ 8150-0073	8150-4000/ 8150-4007/ 8150-0073	8150-4000/ 8150-4007/ 8150-0073
Version for oxygen service (cold box)	8150-0116	8150-0116	8150-0116	8150-0116
Application	Bellows seal/insulating section	Packing	Threaded bushing	
Number within drawing (see section 1.3)	7	34	12	
Type 3510	8150-4000/ 8150-4007/ 8150-0073	8150-4000/ 8150-4007/ 8150-0073	8150-4000/ 8150-4007/ 8150-0073	
Version for oxygen service (cold box)	8150-0116	8150-0116	8150-0116	

¹⁾ Only for version with bellows seal/insulating section

4 Tools

4.1 Tool sets

Valve size		Tool	Material no.	Image
DN	NPS			
15 to 25	½ to 1	Tool kit for standard version of micro-flow valve	1280-3050	
15 to 25	½ to 1	Tool kit (discontinued) for low-temperature version of micro-flow valve	1280-3189	

Special tools



The following tools are additionally required for installation or removal:

Valve size		Tool	Material no.	Image
DN	NPS			
15 to 25	½ to 1	Torque wrench	9932-3812	
15 to 25	½ to 1	Socket wrench ¹⁾ Version with groove	9118-8425	-

¹⁾ Only required for old bellows seal version (manufactured until around 1998). The socket wrench (material no. 1280-3002) for new bellows seal versions (manufactured from 1998 onwards) is included in the tool kit (1280-3050) for micro-flow valves.

1 Information on Type 2780 Valve

1.1 Technical data

		Type 2780-1	Type 2780-2
Image			
Actuator areas	cm ²	120	
Travel	mm	6, 12 or 15	
Associated product documentation	Data sheets	▶ T 5840	
	Mounting and operating instructions	▶ EB 5840	

1.2 Note on actuators with preloaded springs

⚠ WARNING

Risk of personal injury due to preloaded springs.

Valves in combination with pneumatic actuators with preloaded springs are under tension. These control valves with SAMSON pneumatic actuators can be identified by the long bolts protruding from the bottom of the actuator. Additionally, these actuators are marked by an adhesive label.

→ Before starting any work on the actuator, relieve the compression from the preloaded springs (see associated actuator documentation).

1.3 Parts

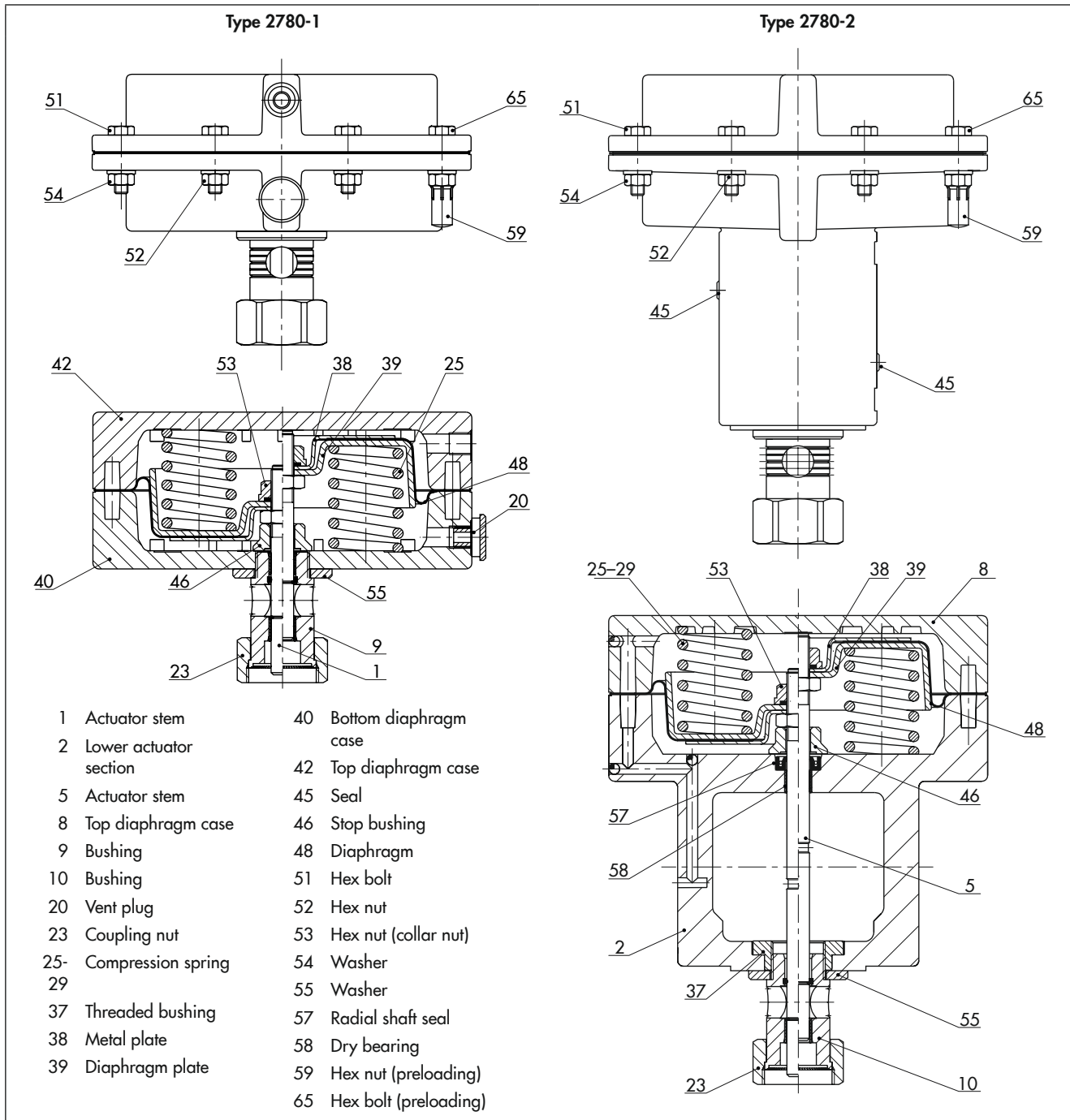

i Note

Parts of actuators with other actuator areas are listed at ► www.samsongroup.com > Product documentation.

2 Tightening torques

Part	Tightening torque in Nm
Nuts (54) to connect the top and bottom diaphragm cases	8
Nuts (59) to connect the top and bottom diaphragm cases when the actuator springs are compressed	15
Coupling nut (23)	20
Collar nut (53)	25

3 Lubricant

⚠ WARNING

Damage to health after contact with hazardous substances.

Certain lubricants (e.g. 8150-0111) are classified as hazardous substances. These substances have a special label and a material safety data sheet (MSDS) issued by the manufacturer.

- Make sure that an MSDS is available for any hazardous substance used. If necessary, contact the manufacturer to obtain an MSDS.
- Inform operating personnel about the hazardous substances and their correct handling.

Application	Trade name	Quantity [g]	Color	Material no. of lubricant
Actuator stem (5)	Gleitmo® 591	10	White	8150-0111

4 Tools

Tool description	Material no.	Image
Mandrel for radial shaft seal (57)	1280-3061	
Mandrel for dry bearing (58)	1280-3025	
Punch	1280-3084	
Lifting fixture (30 kg working load limit)	1280-3094	

1 Information on Type 3271 and Type 3277 Actuators

1.1 Technical data for Type 3271

		Type 3271
Image		
Actuator areas	cm ²	60, 80, 120, 175, 240, 350, 355, 700, 750, 1000, 1400-60, 1400-120, 1400-250, 2800, 2 x 2800
Travel	mm	7.5 to 250
Associated product documentation	Data sheets	▶ T 8310-1, ▶ T 8310-2, ▶ T 8310-3, ▶ T 8310-8
	Mounting and operating instructions	▶ EB 8310-X

1.2 Technical data for Type 3277

		Type 3277
Image		
Actuator area	cm ²	120, 175, 240, 350, 355, 700, 750
Travel	mm	7.5 to 60
Associated product documentation	Data sheet	▶ T 8310-1
	Mounting and operating instructions	▶ EB 8310-X

1.3 Note on actuators with preloaded springs

⚠ WARNING

Risk of personal injury due to preloaded springs.

Valves in combination with pneumatic actuators with preloaded springs are under tension. These control valves with SAMSON pneumatic actuators can be identified by the long bolts protruding from the bottom of the actuator. Additionally, these actuators are marked by an adhesive label.

➔ Before starting any work on the actuator, relieve the compression from the preloaded springs (see associated actuator documentation).

1.4 Parts

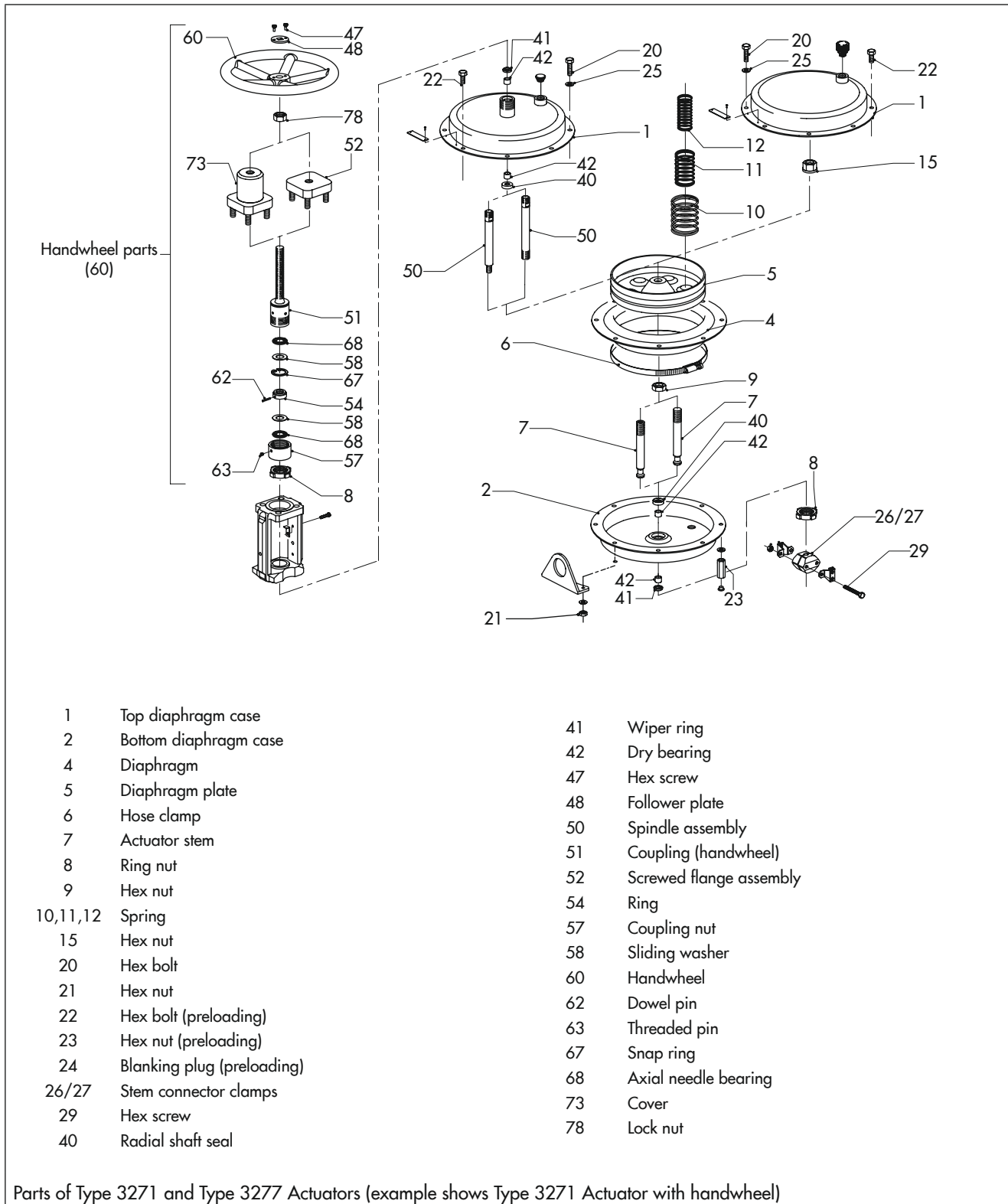

i Note

Parts of actuators with other actuator areas are listed at ► www.samsongroup.com > Product documentation.

2 Tightening torques

2.1 Tightening torques for nuts to connect the top and bottom diaphragm cases

Actuator area in cm ²	Tightening torque for nuts (21) in Nm
120	8
175	15
240	15
350, 355	15
700	20
750	30
1000	35
1400-60	30
1400-120	15 to 20
1400-250	30
2800	50

2.2 Tightening torques for nuts to connect the top and bottom diaphragm cases when the actuator springs are compressed

Actuator area in cm ²	Tightening torque for nuts (23) in Nm
175	15
240	15
350, 355	15
700	20
750	25
1000	35
1400-60	30
1400-120	60
1400-250	50
2800, 2 x 2800	50





2.3 Tightening torques for ring nut

Actuator area in cm ²	Thread	Tightening torque for ring nut (8) in Nm
120, 175 (for micro-flow valve)	M20x1.5	100
120 to 750	M30x1.5	150
1000	M60x1.5	–
1400-60	M60x1.5	–
1400-120	M100x2	–
1400-250	M100x2	–
2800	M100x2	–

Tightening torques

Special tools

The following tools are additionally required to tighten the ring nut (8) of actuators with 750 cm² and smaller:

Nm	Connections		Tool	Material no.	Image
60 to 320	14x18 mm		Interchangeable head torque wrench	9932-2238	
110	-	-	Slotted nut wrench for torque wrench in 120 cm ² version for micro-flow valve	1280-3015	
150	-	-	Castellated nut wrench for torque wrench	1280-3118	

2.4 Tightening torques for collar nut

Actuator area in cm ²	Tightening torque for collar nut (15 or 33 ¹⁾ or 83 ²⁾ in Nm
175	25
240	35
350, 355, 700, 750, 1000	160
2800, 2 x 2800	600

¹⁾ 33 only applies to 175 cm² actuators

²⁾ 83 only applies to 2800 and 2 x 2800 cm² actuators

2.5 Tightening torques for retaining nut

Actuator area in cm ²	Tightening torques for retaining nut (82) in Nm
1400-60	260
1400-120	250
1400-250 ¹⁾	250

¹⁾ For "stem retracts" direction of action: 82; for "stem extends" direction of action: 174

2.6 Tightening torques for nut on compressor

Actuator area in cm ²	Tightening torque for nut (92) in Nm
1000	200

2.7 Tightening torques for hose clamp

Actuator area in cm ²	Tightening torque for adjustable clamp (6) in Nm
240, 350, 700	6
1400-60	Connection between two adjustable clamps: 3 Nm
	Clamp lock of the adjustable clamps: 8 Nm

NOTICE

Risk of property damage and malfunction due to incorrect mounting of the hose clamp.



➔ The clamp lock must be fastened between the two fastening bolts on the top and bottom diaphragm case. Observe instructions in the associated actuator documentation.

i Note

- After performing any repair or maintenance work on the actuator, renew the adjustable clamp.
- Actuators with 120, 175, 355, 750, 1000 and 2800 cm² actuator areas do not have an adjustable clamp.
- Versions of the 1400 cm² actuator exist with and without adjustable clamp. Therefore, it is important to always specify or check the version used when ordering spare parts, for repairs and after-sales inquiries. The configuration ID or the SAMSON order number (including position within the order) is necessary in this case.

Special tools

The following tools are additionally required to tighten the adjustable clamp (6):

Size/Nm	Tool	Connections		Material no.	Image
2 to 10 Nm	Torque wrench with scale	1/4"	■	9932-3811	
	1/4" extension			9932-3228	
	1/4" socket			9932-3302	

2.8 Tightening torques for rod of anti-rotation fixture

Actuator area in cm ²	Tightening torque for rod of anti-rotation fixture (88) in Nm
1400-120	30
1400-250	30

2.9 Tightening torques for stem connector clamps

Plug stem diameter	Thread size	Tightening torque for stem connector clamps (26/27) in Nm
10	M5	5
16	M6	9
22	M12	75 (±5)
40	M16	140 (±5)

3 Lubricant

⚠ WARNING

Damage to health after contact with hazardous substances.

Certain lubricants (e.g. 8150-4008) are classified as hazardous substances. These substances have a special label and a material safety data sheet (MSDS) issued by the manufacturer.

→ Make sure that an MSDS is available for any hazardous substance used. If necessary, contact the manufacturer to obtain an MSDS.

→ Inform operating personnel about the hazardous substances and their correct handling.

3.1 Recommended lubricant

Application	Gasket material and operating medium	Quantity [g]	Temperature range in °C	Color	Material no. of lubricant
Mechanical bearings in the actuators (version for water) Valve lubricant	NBR: water	100	-20 to +160	Light brown	8150-4032
Points of support and threaded spindle in actuators	NBR: air	100	-30 to +130	Black	8152-1002
		400			8152-1001
Mechanical bearings in Type 3271 Actuators	-	-	Up to +200	Red	8150-0012
Screws (stainless steel)	-	-	Up to +200	White/gray	8150-0085
Valves for oxygen service (free of oil and grease)	EPDM/PVMQ: air EPDM: oxygen	60	-60 to +250	White	8150-0116
Spring compression	-	250	-180 to +1200	Gray	8150-4008
2800 and 2 x 2800 cm ² actuators	-	400	Up to +200 °C	Red	8150-0012

3.2 Lubricant sorted by parts and versions

Application	Thread on the bottom diaphragm case	Actuator stem	Hex bolt	Dry bearing	Hex nut (actuator stem)	Handwheel parts
Number within drawing (see section 1.4)	2	7	20/22	42	15	60
Type 3271	8150-4008	8152-1002/ 8152-1001	8150-0085	8152-1002/ 8152-1001	8152-1002/ 8152-1001	8152-1002/ 8152-1001
Type 3277	8150-4008	8152-1002/ 8152-1001	8150-0085	8152-1002/ 8152-1001	8152-1002/ 8152-1001	8152-1002/ 8152-1001
Version for oxygen service (cold box)	8150-0116	8150-0116	8150-0116	8150-0116	8150-0116	8150-0116
Application	Radial shaft seal	Wiper ring	Dry bearing ¹⁾			
Number within drawing (see section 1.4)	40	41	126, 187			
Type 3271	8152-1002/ 8152-1001	8152-1002/ 8152-1001	8152-1002/ 8152-1001			
Type 3277	8152-1002/ 8152-1001	8152-1002/ 8152-1001	-			
Version for oxygen service (cold box)	8150-0116	8150-0116	8150-0116			

¹⁾ Type 3271 with 1400-250 cm² actuator area only



3.3 Sealant

Application	Material no.
Between top diaphragm case (1) and intermediate ring (180) ¹⁾	8121-4005



¹⁾ Type 3271 with 1400-250 cm² actuator area only

4 Tools

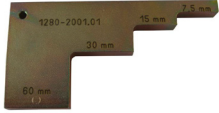
4.1 Type 3271 and Type 3277, 60 to 120 cm² actuator areas

Actuator area	Tool description	Material no.	Image
60 to 120 cm ²	Mandrel for wiper (41)	1280-3023	
	Mandrel for radial shaft seal (40)	1280-3061 (1280-3024)	
	Mandrel for dry bearing (42)	1280-3025	
60 to 120 cm ²	Punch	1280-3084	
60 to 120 cm ²	Lifting fixture (30 kg working load limit)	1280-3094	
60 to 120 cm ²	Travel adjusting gauge	1280-2001	



4.2 Type 3271 and Type 3277, 175 cm² actuator area

Actuator area	Tool description	Material no.	Image
175 cm ²	Mandrel for wiper (41)	1280-3023	
	Mandrel for radial shaft seal (40)	1280-3061 (1280-3024)	
	Mandrel for dry bearing (42)	1280-3025	
175 cm ²	Punch	1280-3084	
175 cm ²	Lifting fixture (100 kg working load limit)	1280-3072	

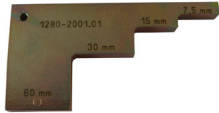
Tools

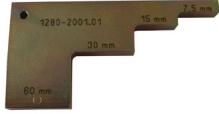

Actuator area	Tool description	Material no.	Image
175 cm ²	Travel adjusting gauge	1280-2001	

4.3 Type 3271 and Type 3277, 240 cm² actuator area

Actuator area	Tool description	Material no.	Image
240 cm ² (Type 3271 only)	Mandrel for wiper (41)	1280-3023	
	Mandrel for radial shaft seal (40)	1280-3061 (1280-3024)	
	Mandrel for dry bearing (42)	1280-3025	
240 cm ² (Type 3277 only)	Mandrel for wiper (41)	1280-3020	
	Mandrel for radial shaft seal (40)	1280-3063 (1280-3021)	
	Mandrel for dry bearing (42)	1280-3022	
240 cm ²	Punch	1280-3084	
240 cm ²	Lifting fixture (100 kg working load limit)	1280-3072	
240 cm ²	Travel adjusting gauge	1280-2001	

4.4 Type 3271 and Type 3277, 350 and 355 cm² actuator areas

Actuator area	Tool description	Material no.	Image
350/355 cm ²	Mandrel for wiper (41)	1280-3020	
	Mandrel for radial shaft seal (40)	1280-3063 (1280-3021)	
	Mandrel for dry bearing (42)	1280-3022	
355 cm ²	Mandrel for radial shaft seal (40) Special version for actuator with travel stop	1280-3169	
	Mandrel for dry bearing (42) Special version for actuator with travel stop	1280-3170	
350/355 cm ²	O-ring sleeve, for actuators with travel stops on both sides (to protect the O-ring from chafing while being mounted)	1280-3198	

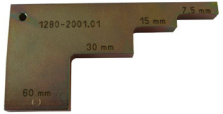
Actuator area	Tool description	Material no.	Image
350/355 cm ²	Punch	1280-3084	
350/355 cm ²	Lifting fixture (100 kg working load limit)	1280-3072	
350/355 cm ²	Travel adjusting gauge	1280-2001	

4.5 Type 3271 and Type 3277, 700 and 750 cm² actuator areas



Actuator area	Tool description	Material no.	Image
700/750 cm ²	Mandrel for wiper (41)	1280-3020	
	Mandrel for radial shaft seal (40)	1280-3063 (1280-3021)	
	Mandrel for dry bearing (42)	1280-3022	
700 cm ²	O-ring sleeve, for actuators with travel stops on both sides (to protect the O-ring from chafing while being mounted)	1280-3206	
750 cm ²	O-ring sleeve (to protect the O-ring from chafing while being mounted)	1280-3198	
750 cm ²	Wrench for slotted nut, SW 24, for actuators with travel stop	1280-3197	
700/750 cm ²	Punch	1280-3084	
750 cm ²	Swivel hoist for lifting the actuator and setting it upright	8442-1017	
750 cm ²	Eyebolt to vertically lift the actuator Thread: M16 Increased height compared to the version without lifting eyelet (measured from top of the diaphragm case): 32 mm ¹⁾	8325-0131	

Tools





Actuator area	Tool description	Material no.	Image
700/750 cm ²	Travel adjusting gauge	1280-2001	

Special tools

The following tools are additionally required:

Size/Nm	Tool	Connections		Material no.	Image
60 to 320 Nm	Torque wrench with scale	14x18 mm		9932-2238	
	Open-end wrench	14x18 mm	SW 32 mm	9932-3371	

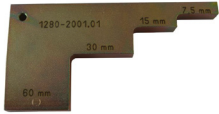

4.6 Type 3271, 1000 cm² actuator area

Actuator area	Tool description	Material no.	Image
1000 cm ²	Mandrel for wiper (41)	1280-3077	
	Mandrel for radial shaft seal (40)	1280-3075	
1000 cm ²	Socket wrench SW 24 (actuator stem extends)	1280-3181	
	Socket wrench SW 24 (actuator stem retracts)	1280-3199	
	Socket wrench SW 36	1280-3182	
1000 cm ²	Punch	1280-3083	
1000 cm ²	Swivel hoist for lifting the actuator and setting it upright	8442-1018	
1000 cm ²	Eyebolt to vertically lift the actuator Thread: M24 Increased height compared to the version without lifting eyelet (measured from top of the diaphragm case): 46 mm ¹⁾	8325-0135	

Actuator area	Tool description	Material no.	Image
1000 cm ²	Travel adjusting gauge	1280-2001	

Special tools

The following tools are additionally required:

Size/Nm	Tool	Connections	Material no.	Image
60 to 320 Nm	Torque wrench with scale	14x18 mm 	9932-2238	
	Open-end wrench	14x18 mm SW 32 mm	9932-3371	

4.7 Type 3271, 1400 cm² actuator area



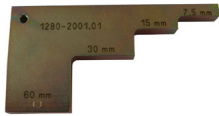

Actuator area	Tool description	Material no.	Image
1400-60 cm ²	Mandrel for wiper (41)	1280-3077	
	Mandrel for radial shaft seal (40)	1280-3075	
1400-120 cm ² 1400-250 cm ²	Mandrel for wiper (41)	1280-3076	
	Mandrel for radial shaft seal (40)	1280-3078	
1400 cm ²	Mandrel for 1400 cm ² actuators with travel stops on both sides	1280-3205	
1400-60 cm ²	Punch for dry bearing (42)	1280-3083	
1400-120 cm ² 1400-250 cm ²	Punch for dry bearing (42, 187 ¹⁾)	1280-3082	
1400-250 cm ²	Punch for dry bearing (126)	1280-3083	
1400 cm ²	Punch for 1400 cm ² actuators with travel stops on both sides	1280-3204	
1400-120 cm ² 1400-250 cm ²	Swivel hoist for lifting the actuator and setting it upright	8442-1019	
1400-120 cm ² 1400-250 cm ²	Eyebolt to vertically lift the actuator Increased height compared to the version without lifting eyelet (measured from top of the diaphragm case): 90 mm	8325-1101	

Tools

Actuator area	Tool description	Material no.	Image
1400 cm ²	Travel adjusting gauge	1280-2001	

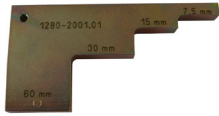

¹⁾ Type 3271 with 1400-250 cm² actuator area only

4.8 Type 3271, 2800 and 2 x 2800 cm² actuator areas



Actuator area	Tool description	Material no.	Image
2800/2 x 2800 cm ²	Tool kit Facilitates diaphragm replacement and reversal of the fail-safe action	1280-4010	–
2800 cm ²	Mandrel for wiper (41)	1280-3076	
	Mandrel for radial shaft seal (40)	1280-3078	
2800 cm ²	Punch	1280-3082	
2800/2 x 2800 cm ²	Swivel hoist for lifting the actuator and setting it upright	8442-1019	
2800/2 x 2800 cm ²	Eyebolt to vertically lift the actuator Thread: M38 Increased height compared to the version without lifting eyelet (measured from top of the diaphragm case): 65 mm ¹⁾	8325-1101	
2800/2 x 2800 cm ²	Travel adjusting gauge	1280-2001	

1 Information on Type 3371 and Type 3372 Actuators

1.1 Technical data for Type 3371

		Type 3371	
Image			
Actuator area	cm ²	120	350
Associated product documentation	Data sheet	▶ T 8317	
	Mounting and operating instructions	▶ EB 8317	

1.2 Technical data for Type 3372

		Type 3372	
Image			
Actuator area	cm ²	120	350
Associated product documentation	Data sheet	▶ T 8313	
	Mounting and operating instructions	▶ EB 8313-1 (with integral positioner) ▶ EB 8313-3 (with directly attached positioner)	

1.3 Note on versions of Type 3372

i Note

The Type 3372 Pneumatic Actuator is available in different versions:

- Type 3372 with 120 cm² actuator area and integral positioner
- Type 3372 with 120 or 350 cm² actuator area and Type 3725 Positioner (direct attachment)

1.4 Note on actuators with preloaded springs

⚠ WARNING

Risk of personal injury due to preloaded springs.

Valves in combination with pneumatic actuators with preloaded springs are under tension. These control valves with SAMSON pneumatic actuators can be identified by the long bolts protruding from the bottom of the actuator. Additionally, these actuators are marked by an adhesive label.

➔ Before starting any work on the actuator, relieve the compression from the preloaded springs (see associated actuator documentation).

1.5 Parts

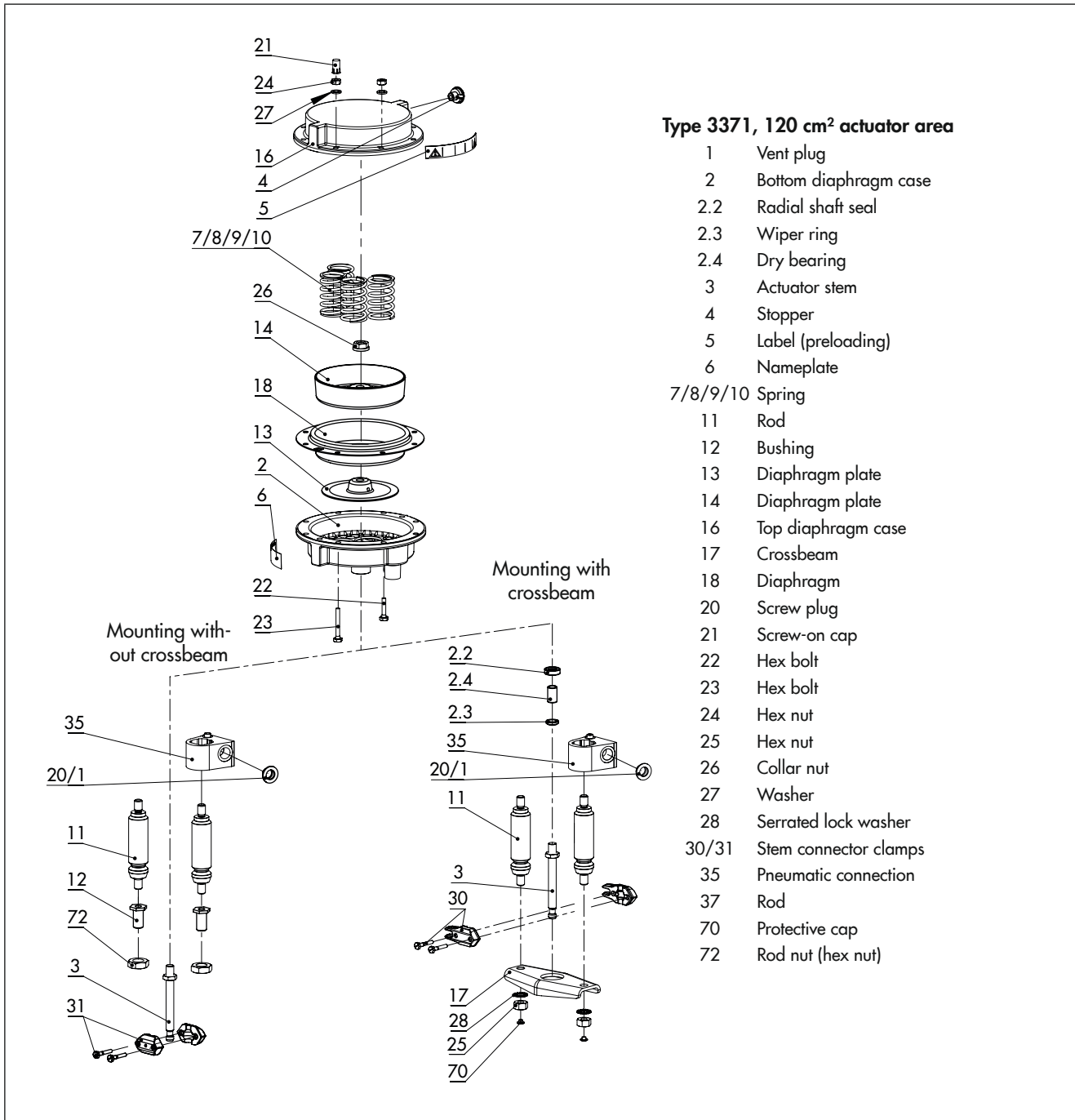

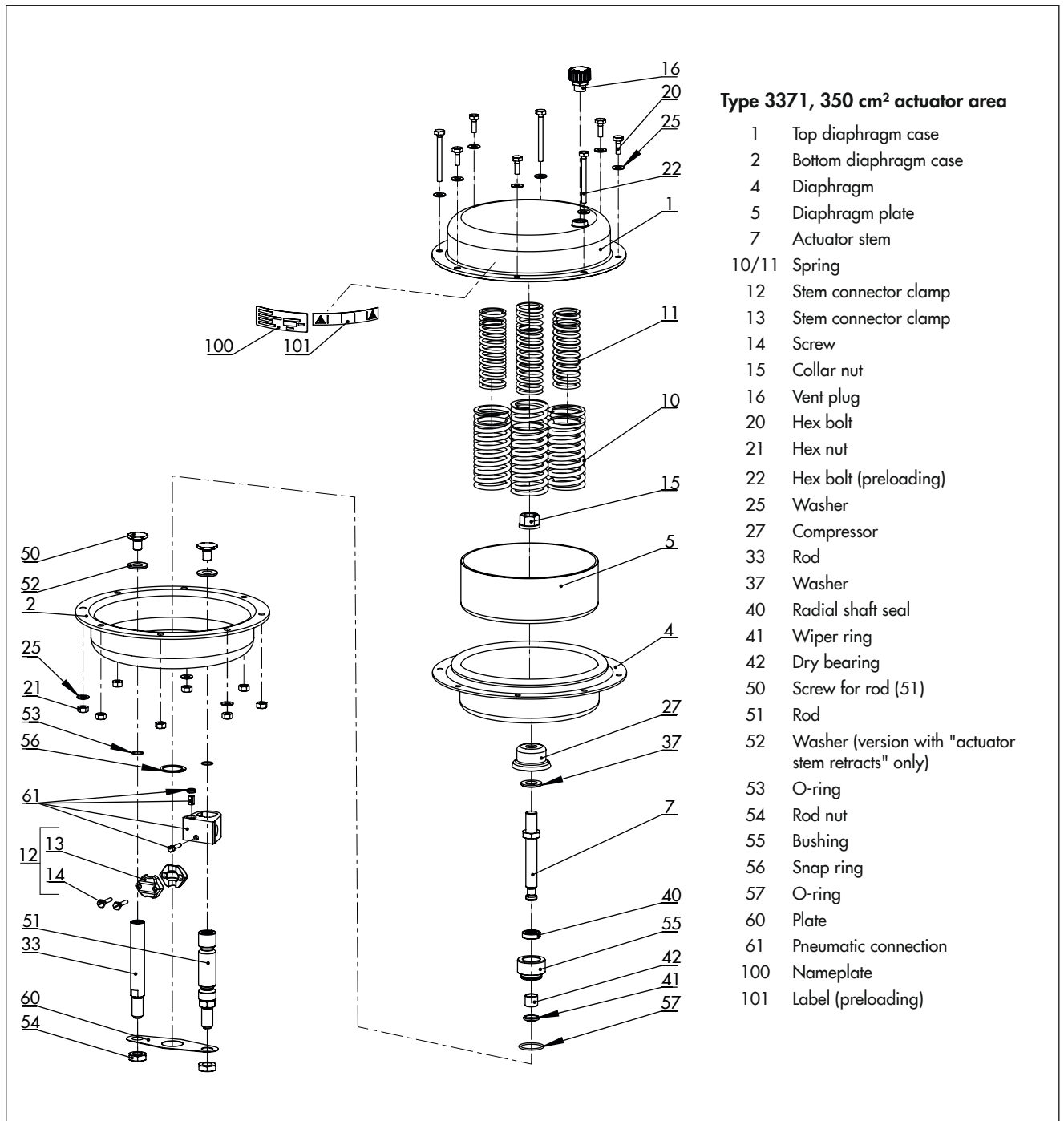

2 Tightening torques

Note concerning the following specifications

- All tightening torques specified in Nm
- Tightening torque tolerance: $\pm 10\%$
- The tightening torques are based on a friction coefficient of 0.06 with a lubricated seat thread and facing.
- After long operating times or long periods or use at temperatures above 250 °C, the breakaway torque may be twice as high as the tightening torque.

i Note

The tightening torques apply to both Type 3371 and Type 3372.

2.1 Tightening torques for nuts to connect the top and bottom diaphragm cases

Actuator area in cm ²	Tightening torque for nuts (21, 23) in Nm
120	7
350	15

2.2 Tightening torques for screws on rods

Actuator area in cm ²	Tightening torque for screw (50) in Nm
120	35
350	70 (± 10)

2.3 Tightening torques for collar nut

Actuator area in cm ²	Tightening torque for collar nut (15) [Nm]
120	35
350	160

2.4 Tightening torques for stem connector clamps

Actuator area in cm ²	Tightening torque for stem connector clamps (30/31 for 120 cm ² ; 12 for 350 cm ²) in Nm
120	5
350	9

3 Lubricant

⚠ WARNING

Damage to health after contact with hazardous substances.

Certain lubricants (e.g. 8150-4008) are classified as hazardous substances. These substances have a special label and a material safety data sheet (MSDS) issued by the manufacturer.

→ Make sure that an MSDS is available for any hazardous substance used. If necessary, contact the manufacturer to obtain an MSDS.

→ Inform operating personnel about the hazardous substances and their correct handling.

3.1 Recommended lubricant



Application	Gasket material and operating medium	Quantity [g]	Temperature range in °C	Color	Material no. of lubricant
Mechanical bearings in the actuators (version for water) Valve lubricant	NBR: water	100	-20 to +160	Light brown	8150-4032
Points of support and threaded spindle in actuators	NBR: air	100	-30 to +130	Black	8152-1002
		400			8152-1001
Spring compression	-	250	-180 to +1200	Gray	8150-4008
Screws (stainless steel)	-	-	Up to 200 °C	White	8150-0085

3.2 Lubricant sorted by parts and versions



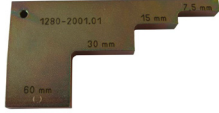

Application	Actuator stem	Collar nut	Hex bolt	Radial shaft seal	Wiper ring	Dry bearing	Screw
Number within drawing (see section 1.5)	7	15	20/22	40	41	42	50
Type 3371	8152-1002 8152-1001	8152-1002 8152-1001	8150-0085	8152-1002 8152-1001	8152-1002 8152-1001	8152-1002 8152-1001	8152-1002 8152-1001
Type 3372	8152-1002 8152-1001	8152-1002 8152-1001	8150-0085	8152-1002 8152-1001	8152-1002 8152-1001	8152-1002 8152-1001	8152-1002 8152-1001

4 Tools

4.1 Type 3371 and Type 3372, 120 cm² actuator area

Actuator area	Tool description	Material no.	Image
120 cm ²	Mandrel for wiper	1280-3023	
	Mandrel for radial shaft seal	1280-3061 (1280-3024)	
	Mandrel for dry bearing	1280-3025	
120 cm ²	Punch	1280-3084	
120 cm ²	Lifting fixture (30 kg working load limit)	1280-3094	
120 cm ²	Travel adjusting gauge	1280-2001	

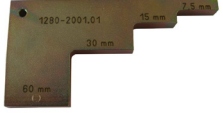

4.2 Type 3371 and Type 3372, 350 cm² actuator area

Actuator area	Tool description	Material no.	Image
350 cm ²	Mandrel for wiper (41)	1280-3020	
	Mandrel for radial shaft seal (40)	1280-3063 (1280-3021)	
	Mandrel for dry bearing (42)	1280-3022	
350 cm ²	O-ring sleeve, for actuators with travel stops on both sides (to protect the O-ring from chafing while being mounted)	1280-3198	
350 cm ²	Punch	1280-3084	
350 cm ²	Lifting fixture (100 kg working load limit)	1280-3072	

Actuator area	Tool description	Material no.	Image
350 cm ²	Travel adjusting gauge	1280-2001	

Special tools

The following tools are additionally required:

Size/Nm	Tool	Connections		Material no.	Image
60 to 320 Nm	Torque wrench with scale	14x18 mm		9932-2238	
	Open-end wrench	14x18 mm	Width across flats 32	1280-3186	
	Socket (assembly)	-	Width across flats 13	1280-3108	-



1 Information on Type 3275 Valve

1.1 Technical data

		Type 3275
Image		
Actuator areas		314, 490 and 804 cm ²
Travel		15 or 30 mm
Associated product documentation	Data sheet	▶ T 8314
	Mounting and operating instructions	▶ EB 8314

1.2 Parts

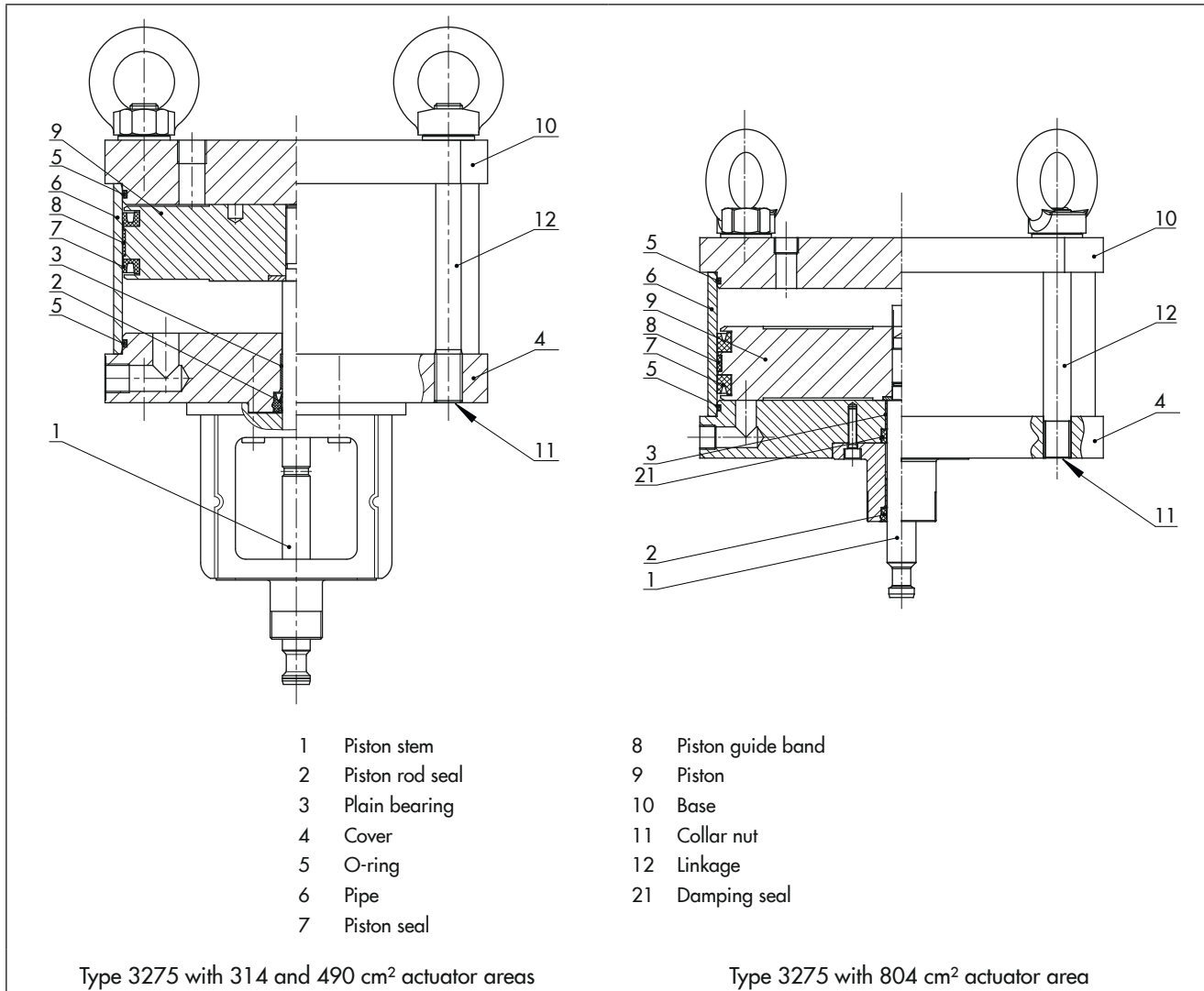

2 Tightening torques

2.1 Tightening torques for tie rods

Cylinder diameter in mm	Tightening torque for tie rod (12) in Nm
200	106 to 143
250	187 to 253
320	298 to 403

3 Lubricant

i Note

The lubricant to be used is included with the set of parts subject to wear.

Do not use any other lubricants.

Contact SAMSON's After-sales Service.

Parts to be lubricated

- Spaces where the seals are to be installed
- Seals: piston rod seal (2), O-ring (5), damping seal (21), piston seal (7), piston guide band (8)
- Face of the cylinder barrel (6)
- Face of the piston rod (1)
- Grease chambers at the piston seal (7)
- Grease chambers at the piston rod seal (2)

4 Tools

No special tools are required to assemble or disassemble the Type 3275 Pneumatic Piston Actuator.



1 Information on Type 3275A

1.1 Technical data

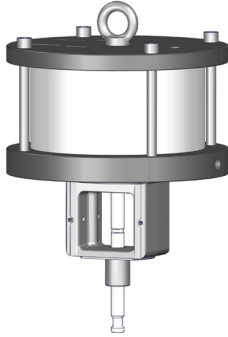
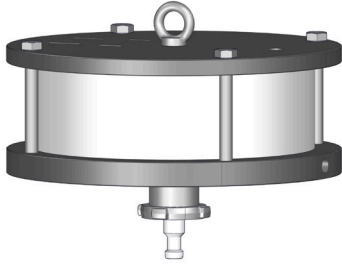
		Type 3275	
Image			
	Actuator areas	314, 380 and 490 cm ²	804 cm ²
Travel		30 mm rated travel (15 and 19 mm on request)	
Associated product documentation	Data sheet	▶ T 8314-1	
	Mounting and operating instructions	▶ EB 8314-1	

1.2 Parts

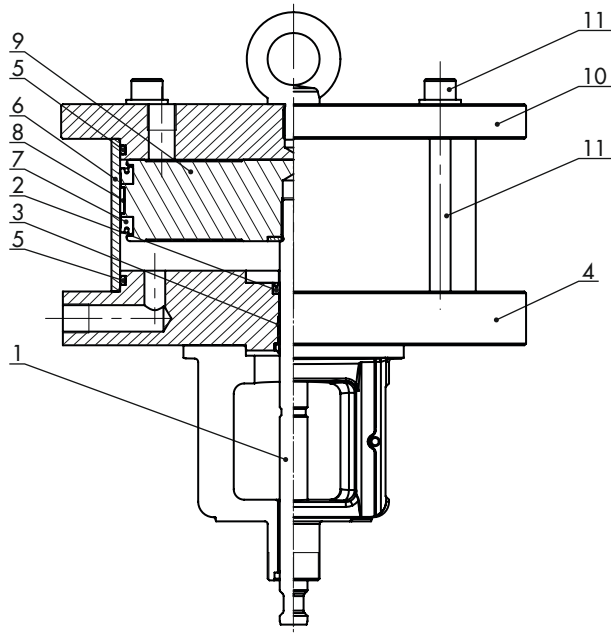

Type 3275A · Version with 314/380/490 cm²

- 1 Piston stem
- 2 Piston rod seal
- 3 Plain bearing
- 4 Cover
- 5 O-ring
- 6 Pipe
- 7 Piston seal
- 8 Piston guide band
- 9 Piston
- 10 Base
- 11 Linkage

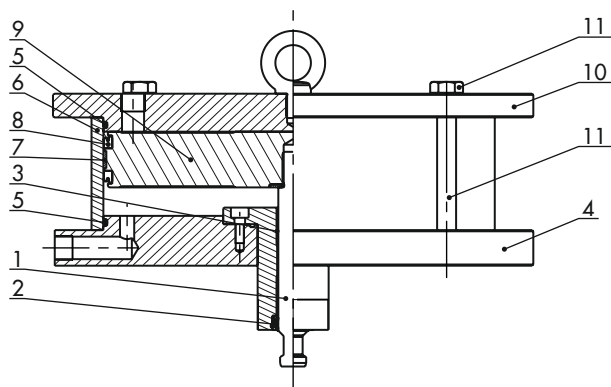

Type 3275A · Version with 804 cm²

2 Tightening torques

2.1 Tightening torques for tie rods

Piston diameter in mm	Tightening torque for tie rod (11) in Nm
200	60 (M12 screw)
220	60 (M12 screw)
250	60 (M12 screw)
320	144 (M16 screw)

3 Lubricant

i Note

OKS 475¹⁾ lubricant must be used in this case. Approx 15 g is sufficient to relubricate when gaskets are renewed. Do not use any other lubricants. Contact SAMSON's After-sales Service.

¹⁾ OKS 475 lubricant is a commercially available lubricant.

Parts to be lubricated

- Spaces where the seals are to be installed
- Seals: piston rod seal (2), O-ring (5), piston seal (7), piston guide band (8)
- Face of the cylinder barrel (6)
- Face of the piston rod (1)
- Grease chambers at the piston seal (7)
- Grease chambers at the piston rod seal (2)

4 Tools

No special tools are required to assemble or disassemble the Type 3275A Pneumatic Piston Actuator.

1 Information on Type 3571 Valve

1.1 Technical data

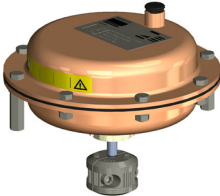
		Type 3571
Image		
Actuator area	in ²	27, 54, 116
	cm ²	175, 350, 750
Associated product documentation	Data sheet	▶ T 8820
	Mounting and operating instructions	▶ EB 8820

i Note

The Type 3571 Actuator is only sold through SAMSON USA.

1.2 Note on actuators with preloaded springs

⚠ WARNING

Risk of personal injury due to preloaded springs.

Valves in combination with pneumatic actuators with preloaded springs are under tension. These control valves with SAMSON pneumatic actuators can be identified by the long bolts protruding from the bottom of the actuator. Additionally, these actuators are marked by an adhesive label.

→ Before starting any work on the actuator, relieve the compression from the preloaded springs (see associated actuator documentation).

1.3 Parts

- Exploded diagram of actuator with 27 and 116 in² (175 and 750 cm²) actuator area, see page 162
- Exploded diagram of actuator with 54 in² (350 cm²) actuator area, see page 163

Information on Type 3571 Valve

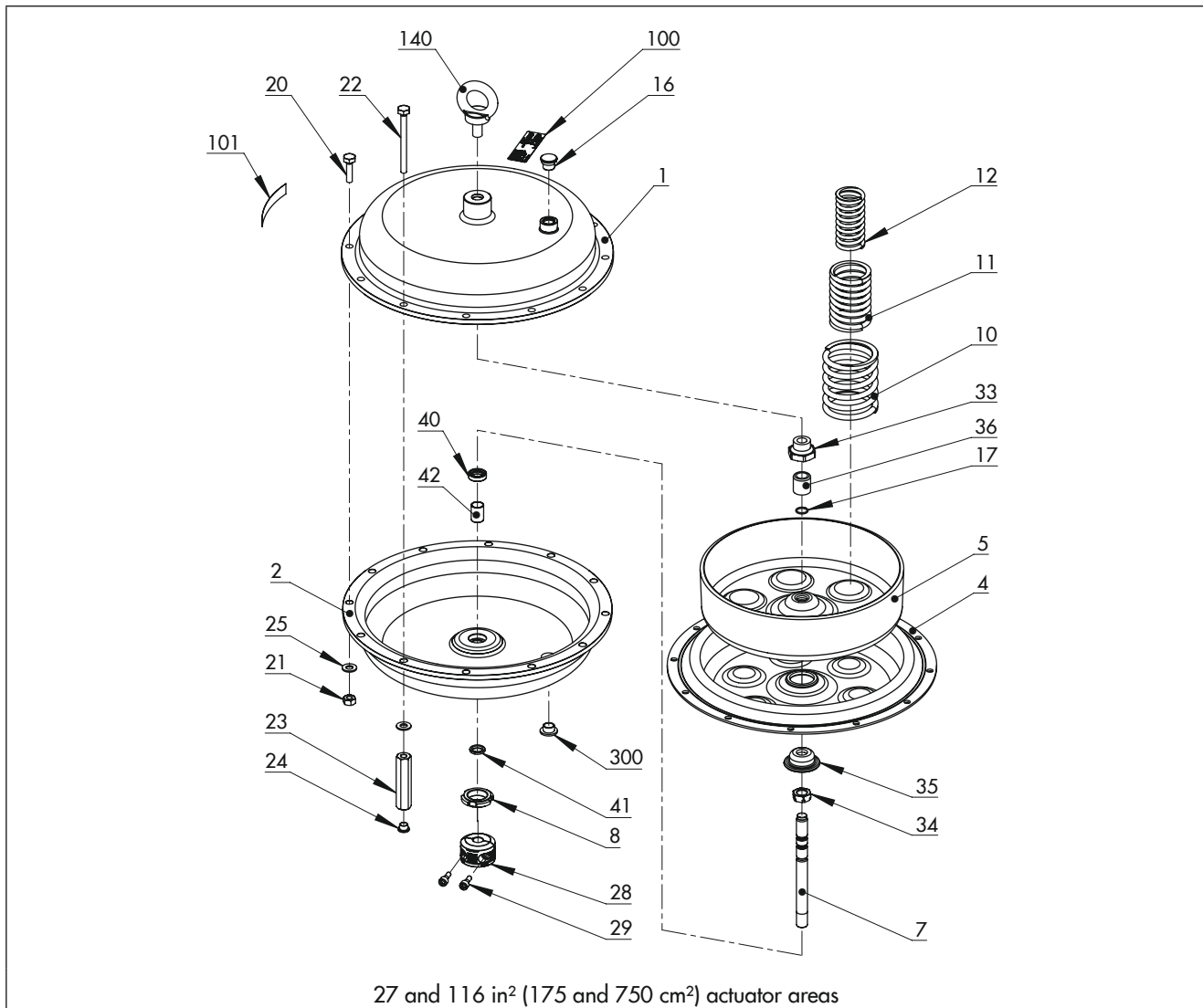

- | | | | |
|----|-----------------------|-----|------------------------------|
| 1 | Top diaphragm case | 25 | Washer |
| 2 | Bottom diaphragm case | 28 | Stem connector clamp |
| 4 | Diaphragm | 29 | Hex screw |
| 5 | Diaphragm plate | 33 | Nut |
| 7 | Actuator stem | 34 | Slotted nut ¹⁾ |
| 8 | Ring nut | 35 | Compressor |
| 10 | Spring (external) | 36 | Spacer |
| 11 | Spring (internal) | 40 | Radial shaft seal |
| 12 | Spring (internal) | 41 | Wiper ring |
| 16 | Vent plug | 42 | Dry bearing |
| 17 | O-ring | 100 | Nameplate |
| 20 | Hex bolt | 101 | Label (preloading) |
| 21 | Hex nut | 140 | Lifting eyelet ¹⁾ |
| 22 | Hex bolt (preloading) | 300 | Stopper |
| 23 | Hex nut (preloading) | | |
| 24 | Stopper | | |
- ¹⁾ Only for 116 in²/750 cm² actuator areas

2 Tightening torques

See section 1.3 for position numbers

2.1 Tightening torques for nuts to connect the top and bottom diaphragm cases





Actuator area		Tightening torque for nuts (21, 23) in Nm
in ²	cm ²	
27	175	12 to 15
54	350	15
116	750	25

2.2 Tightening torques for ring nut

Actuator area		Tightening torque for ring nut (8) in Nm
in ²	cm ²	
27	175	150
54	350	150
116	750	150

Special tools

The following tools are additionally required to tighten the ring nut (8):

Nm	Connections	Tool	Material no.	Image
60 to 320	14x18 mm	 Interchangeable head torque wrench	9932-2238	
150	-	 Castellated nut wrench for torque wrench	1280-3118	

2.3 Tightening torques for collar nut

Actuator area		Tightening torque for collar nut (15) [Nm]
in ²	cm ²	
27	175	-
54	350	160
116	750	-

2.4 Tightening torques for nut on compressor

Actuator area		Tightening torque for nuts (33) on compressor (35) in Nm
in ²	cm ²	
27	175	25
54	350	-
116	750	75

2.5 Tightening torques for hose clamp

Actuator area		Tightening torque for adjustable clamp (6) in Nm
in ²	cm ²	
27	175	–
54	350	6
116	750	–

NOTICE

Risk of property damage and malfunction due to incorrect mounting of the hose clamp.



→ The clamp lock must be fastened between the two fastening bolts on the top and bottom diaphragm case.

Note

After performing any repair or maintenance work on the actuator, renew the adjustable clamp.

Special tools

The following tools are additionally required to tighten the adjustable clamp (6):

Size/Nm	Tool	Connections		Material no.	Image
2 to 10 Nm	Torque wrench with scale	1/4"	■	9932-3811	
	1/4" extension			9932-3228	
	1/4" socket			9932-3302	

2.6 Tightening torques for stem connector clamps

Type 3525 Valve	Valve size	Tightening torque for screw (29) on stem connector clamps (28) in Nm
Standard	NPS 1 to 3	15
Compact	NPS 1	5

3 Lubricant

⚠ WARNING

Damage to health after contact with hazardous substances.

Certain lubricants (e.g. 8150-4008) are classified as hazardous substances. These substances have a special label and a material safety data sheet (MSDS) issued by the manufacturer.

→ Make sure that an MSDS is available for any hazardous substance used. If necessary, contact the manufacturer to obtain an MSDS.

→ Inform operating personnel about the hazardous substances and their correct handling.

3.1 Recommended lubricant



Application	Gasket material and operating medium	Quantity [g]	Temperature range in °C	Color	Material no. of lubricant
Points of support and threaded spindle in actuators	NBR: air	400	-30 to +130	Black	8152-1001
Valves for oxygen service (free of oil and grease)	EPDM/PVMQ: air EPDM: oxygen	60	-60 to +250	White	8150-0116

3.2 Lubricant sorted by parts and versions



Application	Radial shaft seal	Wiper ring	Dry bearing
Number within drawing (see section 1.3)	40	41	42
Type 3571	8152-1001/8150-0116	8152-1001/8150-0116	8152-1001/8150-0116

4 Tools



4.1 Type 3571, 27 in² or 175 cm² actuator area

Actuator area		Tool description	Material no.	Image
in ²	cm ²			
27	175	Mandrel for wiper (41)	1280-3023	
		Mandrel for radial shaft seal (40)	1280-3061	
		Mandrel for dry bearing (42)	1280-3025	
		Punch	1280-3084	

4.2 Type 3571, 54 in² or 350 cm² actuator area

Actuator area		Tool description	Material no.	Image
in ²	cm ²			
54	350	Mandrel for wiper (41)	1280-3020	
		Mandrel for radial shaft seal (40)	1280-3063	
		Mandrel for dry bearing (42)	1280-3022	
		Punch	1280-3084	

4.3 Type 3571, 116 in² or 750 cm² actuator area

Actuator area		Tool description	Material no.	Image
in ²	cm ²			
116	750	Mandrel for wiper (41)	1280-3020	
		Mandrel for radial shaft seal (40)	1280-3063	
		Mandrel for dry bearing (42)	1280-3022	
		Punch	1280-3084	
		Wrench for slotted nut	1280-3197	
		O-ring sleeve (to protect the O-ring from chafing while being mounted)	1280-3198	