



EB 8389-1S EN

Translation of original instructions

Tag no.:	SAG	
Operating hours counter:	00:14:13	
Current operating mode:	Automatic	
Switch position (ATO/ATC):	ATO (air to open; closing)	
Centralized fault:	<input checked="" type="checkbox"/>	
Set point [w]:	77,3 %	
Actual value [x]:	77,3 %	
Error [e]:	0,0 %	
Supply pressure:	5,0 bar	
Signal pressure p out:	0,6 bar	
Temperature:	24,0 °C	

Performance	Valve	Actuator	Positioner
o.k.	o.k.	o.k.	o.k.

EXPERTplus Valve Diagnostics

TROVIS SAFE 3730-6 Electropneumatic Positioner



The mounting and operating instructions for the devices are included in the scope of delivery. The latest documentation is available on our website at www.samson.de > **Service & Support** > **Downloads** > **Documentation**.

Definition of signal words

DANGER

Hazardous situations which, if not avoided, will result in death or serious injury

WARNING

Hazardous situations which, if not avoided, could result in death or serious injury

NOTICE

Property damage message or malfunction

Note

Additional information

Tip

Recommended action

1	Description.....	7
1.1	General	7
1.2	Start-up.....	9
1.3	Diagnostic functions	10
1.3.1	Type of application.....	11
1.3.2	Assessment.....	11
2	Monitoring.....	13
2.1	Status messages.....	13
2.1.1	Resetting status messages	13
2.1.2	Condensed state	17
2.2	Logging.....	18
3	Data logger	21
3.1	Permanent data logging	21
3.2	Triggered data logging.....	22
3.2.1	Triggered by condensed state.....	22
3.2.2	Triggered by set point, valve position, set point deviation or signal pressure.....	23
3.2.3	Triggered by binary input.....	24
3.2.4	Triggered by internal solenoid valve/forced venting.....	25
3.2.5	Triggered by set point or internal solenoid valve/forced venting.....	25
4	Valve signature	27
4.1	Reference graphs	28
4.1.1	Analysis and monitoring.....	28
4.2	Valve signature, signal pressure(x).....	29
4.2.1	Analysis and monitoring.....	30
4.3	Course of supply pressure.....	31
4.3.1	Analysis and monitoring.....	32
4.4	Valve signature, friction(x)	33
4.4.1	Analysis and monitoring.....	34
4.5	Resetting single status messages	34
5	On/off valve.....	37
5.1	Diagnostics for on/off valve.....	38
5.2	Analysis and monitoring.....	39
5.3	Resetting single status messages	40

6	Valve position x histogram	41
6.1	Analysis and monitoring.....	42
6.2	Resetting single status messages	42
7	Set point deviation e histogram	44
7.1	Analysis and monitoring.....	45
7.2	Resetting single status messages	46
8	Cycle counter histogram	49
8.1	Analysis and monitoring.....	50
8.2	Resetting single status messages	50
9	Leakage sensor	53
9.1	Start-up of the leakage sensor	54
9.1.1	Manufacturer reference	54
9.1.2	Process reference	57
9.2	Short-term monitoring	62
9.2.3	Resetting single status messages	63
9.3	Long-term monitoring	63
9.3.1	Resetting single status messages	63
9.4	Sound level(x).....	64
9.4.2	Resetting single status messages	64
10	Course of end position	67
10.1	Analysis and monitoring.....	68
10.2	Resetting single status messages	68
11	Valve dead band	69
11.1	Resetting single status messages	70
12	Partial stroke test (PST)	73
12.1	Start triggered by the set point	78
12.2	Start triggered by the binary input.....	78
12.3	Analysis and monitoring.....	79
12.4	Resetting single status messages	80
13	Full stroke test (FST)	83
13.1	Analysis and monitoring.....	87

13.2	Resetting single status messages	87
14	SIL operator test	88
14.1	Analysis and monitoring.....	90
15	Binary input.....	91
16	Dynamic HART® variables	93
17	Appendix.....	95
17.1	Code list.....	95
17.2	Error messages and recommended corrective action	102
17.3	Diagnostic data points saved in a non-volatile memory.....	107
17.4	Resetting parameters	108

Overview

Throttling service



On/off service



No configuration required for monitoring

Travel histogram
▶ Section 6

Set point deviation histogram e
▶ Section 7

Cycle counter histogram
▶ Section 8

Course of end position
▶ Section 10

Configuration required for diagnosis

Data logger
▶ Section 3

Valve signature
▶ Section 4

Packing
▶ Section 8

Leakage sensor
▶ Section 9

Valve dead band
▶ Section 11

Full stroke test (FST)
▶ Section 13

No configuration required for monitoring

Travel histogram
▶ Section 6

Set point deviation histogram e
▶ Section 7

Cycle counter histogram
▶ Section 8

Course of end position
▶ Section 10

Configuration required for diagnosis

Data logger
▶ Section 3

On/off diagnosis
▶ Section 5

Packing
▶ Section 8

Leakage sensor
▶ Section 9

Valve dead band
▶ Section 11

Partial stroke test (PST)
▶ Section 12

Full stroke test (FST)
▶ Section 13

Note:

- Tests highlighted in red border require an initialization with valve signature
- Tests highlighted in gray can optimize the proper functioning of safety equipment according to IEC 61508 and IEC 61511, provided these tests are performed regularly.

1 Description

1.1 General

These instructions supplement the standard Mounting and Operating Instructions for the TROVIS SAFE 3730-6 Positioner (► EB 8384-6S).

EXPERTplus is a diagnostic firmware integrated into the positioner which allows the predictive, status-oriented maintenance of valves with pneumatic actuators.

EXPERTplus records the valve condition while the process is running (in automatic mode) and generates messages on the required maintenance work. In addition, numerous tests can be performed in manual mode to pinpoint emerging faults.

The diagnostic functions of EXPERTplus are completely integrated into the positioner. Diagnostic data are compiled, saved and analyzed in the positioner itself. Classified status messages on the state of the valve are generated from the analysis.

Operation using TROVIS-VIEW 4/DD/DTM/eDD

EXPERTplus allows the parameters to be viewed or changed using the TROVIS-VIEW 4 software or DD/DTM/eDD.

TROVIS-VIEW 4 · SAMSON operator interface used to configure various SAMSON devices

- **DTM** · Device type manager to describe the device and communication properties
- **DD/eDD** · Device description/enhanced device description

All the parameter settings that are changed must also be downloaded onto the positioner to allow them to become effective.

Local operation

Some parameters can be changed at the positioner as well as over the operator interface. The positioner code of these parameters are written in parentheses. Refer to the Mounting and Operating Instructions of the TROVIS SAFE 3730-6 Positioner (EB 8384-6S EN) for a list of all parameters that can be changed at the positioner.

The operation described in the following sections illustrates operation using TROVIS-VIEW 4. The default settings of the positioner and TROVIS-VIEW 4 are written in square brackets []. Settings highlighted in gray refer to operation using TROVIS-VIEW 4.

Description

START-UP

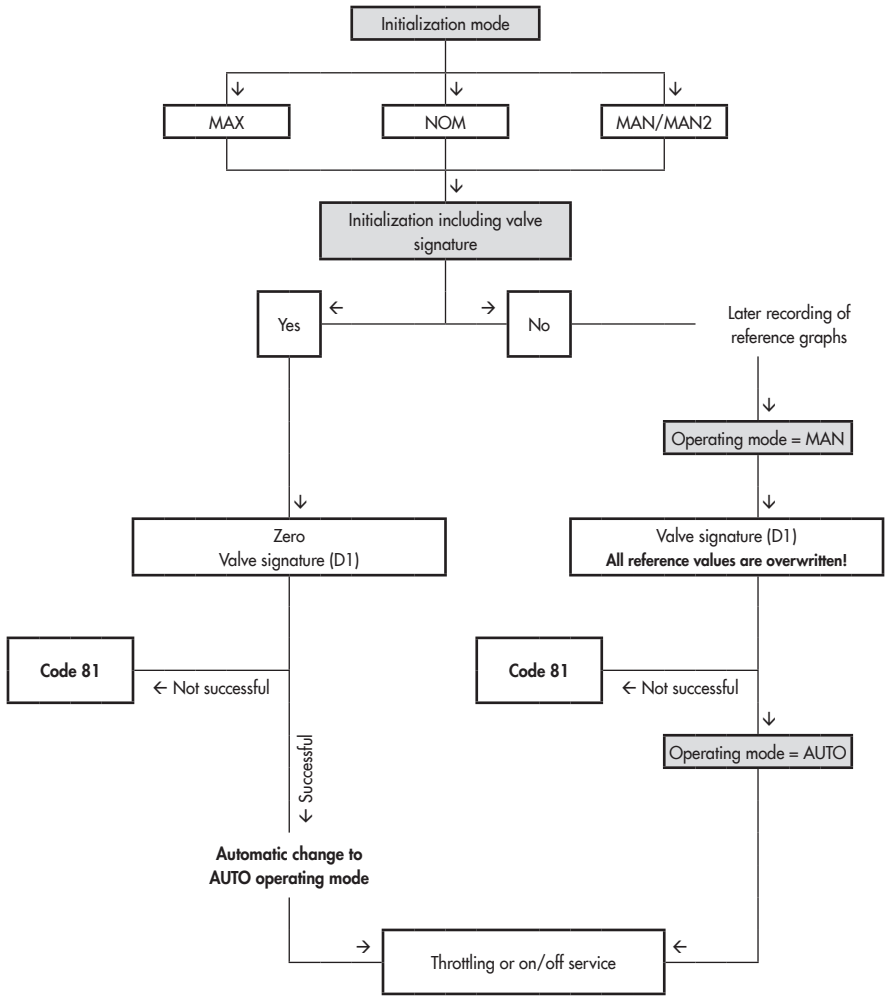

1.2 Start-up

The positioner must be initialized to use the full scope of the valve diagnostics. During initialization the positioner adapts itself optimally to the friction conditions and the signal pressure required by the control valve. The positioner can be initialized using one of the following initialization modes: maximum range (MAX), nominal range (NOM), manual setting 1 (MAN) and manual setting 2 (MAN2).

- **Maximum range (MAX)**
Initialization mode for simple start-up of valves with two clearly defined mechanical end positions, e.g. three-way valves
- **Nominal range (NOM)**
Initialization mode for all globe valves
- **Manual setting 1 (MAN)**
Initialization mode for globe valves requiring OPEN position to be entered manually
- **Manual setting 2 (MAN2)**
Initialization mode for globe valves requiring the end positions (OPEN and CLOSED positions) to be entered manually

The type of application, pressure limit and the start-up parameters required for the selected initialization must be entered to initialize the positioner.

i Note

Positioner start-up is described in detail in the associated Mounting and Operating Instructions (► EB 8384-6S).

The monitoring of friction, supply pressure, leakage, actuator springs, course of end position and zero point shift requires additional reference tests of the valve signature to be performed. Refer to Section 4. The reference tests required for the diagnostic functions cannot be performed if the positioner has been initialized in the substitute calibration (SUB) mode. By setting 'Initialization including valve signature' = Yes, the positioner records the reference data automatically after initialization.

Start-up

- Type of application (Code 49 - h0): Control valve, [On/off valve]
- Initialization mode (Code 6): [Maximum range (MAX)], Nominal range (NOM), Manual setting 1 (MAN) or Manual setting 2 (MAN2)
- Initialization including valve signature (Code 48 - h0): [Yes]
- Pin position (Code 4): [Off], 17, 25, 35, 50, 70, 100, 200 mm, 90°
- Pressure limit (Code 16): 1.4 to [7.0] bar

During positioner initialization, the 'Kp level' and 'Tv level' are optimally set. If the positioner tends to overshoot impermissibly due to other disturbances, the proportional-action coefficient (Kp level) and derivative-action time (Tv level) can be adapted accordingly. Increment the derivative-action time until the desired behavior is reached. When the maximum value of 4 is reached for the derivative-action time, the proportional-action coefficient can be reduced in steps.

ⓘ NOTICE

K_p level changes affect the set point deviation.

After changing the proportional-action coefficient 'K_p level', we recommend to recalibrate the fine filter in the positioner. Use the 'Fine-tuning after K_p change' function for this.

Start-up > Control parameters

- Proportional-action coefficient K_p level (Code 17): 0 to 17, [7]
- Derivative-action time T_v level (Code 18): Off, 1 to 4, [2]
- Fine-tuning after K_p change

1.3 Diagnostic functions

There are two different types of diagnostic functions:

1. Monitoring functions

Data are compiled, saved and analyzed by the positioner while the process is running without disrupting the process.

The positioner follows the set point to position the valve. A classified status alarm or fault alarm is generated if the positioner detects an event.

2. Dynamic tests

Similar to the monitoring function, data are compiled, saved and analyzed by the positioner. However, in this case, the valve position is not determined by the set point, but by the settings of the test. The dynamic tests can only be started when the conditions in the plant allow it (e.g. plant shutdown or service work in the workshop). For reasons of safety, the dynamic tests, except for partial stroke testing, can only be performed in the MAN operating mode.

A dynamic test is stopped and the positioner changes to the fail-safe position when the electrical signal falls below a certain level or when the solenoid valve is triggered or the forced venting function is activated.

1.3.1 Type of application

Different diagnostic functions are available depending on the type of application selected in EXPERTplus. The types of application 'Control valve' and 'On/off valve' are available. Depending on the type of application selected, the positioner behaves differently in the automatic mode (AUTO):

- **Control valve**
The positioner uses the set point to position the valve.
The valve position (current position) appears in % on the display.
- **On/off valve**
Discrete analysis of the set point
The valve position (current position) in % and O/C (Open/Close) appear in alternating sequence on the display. See
▶ Section 5.

Start-up

– Type of application (Code 49 - h0): Control valve, [On/off valve]

On-site operation Code 49 - h0

- Type of application No, [YES], ESC
No = Control valve
YES = On/off valve

1.3.2 Assessment

Table 1 shows the diagnostic functions and their statements on the condition of the valve depending on the type of application.

Description

Table 1: *Diagnostic functions and test analysis*

Diagnostic functions	Control valve	On/off valve	Assessment	See section
Monitoring				
Data logger	•	•	Depending on trigger status selected	▶ 3 on page 21
Valve signature	•	⊗	– Change in friction – Supply pressure – Defective actuator springs – Pneumatic leakage	▶ 4 on page 27
On/off valve	–	•	– Breakaway time – Transit time – Valve end position	▶ 5 on page 37
Valve position histogram	•	⊗	– Change in manipulated variable range – Manipulated variable range	▶ 6 on page 41
Set point deviation histogram	•	•	– Manipulated variable range limitation – Seat leakage – Positioner-valve linkage – Average set point deviation	▶ 7 on page 44
Cycle counter histogram	•	•	– Packing leakage – Dynamic stress factor	▶ 8 on page 49
Leakage sensor	•	•	– Seat leakage	▶ 9 on page 53
Course of end position	•	•	– Course of end position – Zero shift	▶ 10 on page 67
Dynamic tests				
Valve dead band	•	•	– Dead band	▶ 11 on page 69
Partial stroke test (PST)	•	•	– Overshooting – Dead time – T86 – Settling time	▶ 12 on page 73
Full stroke test (FST)	•	•	– Overshooting – Dead time – T86 – Settling time	▶ 13 on page 83

- Full scope of functions
- ⊗ Function is performed, but not analyzed
- Function is not performed

2 Monitoring

2.1 Status messages

The valve diagnostics integrated into the positioner generates classified status messages.

Messages generated from the analysis of the diagnosis can be classified according to the possible causes. See ► Section 4 to 13.

The following classifications are possible:

- **No message**
If an event is classified as “No message”, this event does not have any affect on the condensed state.
- **Function check**
Test or calibration procedures are performed in the positioner. The positioner is temporarily unable to perform its control task as long as the procedure is taking place.
- **Maintenance request/maintenance required**
The positioner still performs its control task (with restrictions). A maintenance demand or above average wear has been determined. The wear tolerance will soon be exhausted or is reducing at a faster rate than expected. Maintenance is necessary in the medium term.
- **Out of specification**
The positioner is running outside the specified operating conditions.
- **Failure**
The positioner cannot perform its control task due to a functional fault in the positioner itself or in one of its peripherals or

an initialization has not yet been successfully completed.

You can view these messages in TROVIS-VIEW 4 in the **Diagnostics** folder (> Monitoring) and its subfolders. The 'Positioner status', 'Valve status', 'Actuator status' and 'Valve position status' messages provide a condensed state of the status messages of each subfolder.

2.1.1 Resetting status messages

When a status message is generated, you should first locate the source of the fault and take action to remedy it.

For recommended action concerning the status messages see ► Section 17.2.

Status messages can be reset individually or using the reset function. Table 2 on page 15 contains an overview on how the diagnosis can be reset. Resetting is performed in the **Diagnostics** folder (> Service/maintenance > Reset).

If you want to keep measured data and the analysis after resetting the positioner, it is possible to upload them onto a computer.

Resetting single status messages

- Status messages represented by a code in the positioner can be confirmed at the positioner itself. Select the error code and confirm it by pushing the rotary pushbutton. See the standard instructions of the positioner ► EB 8384-6S.
- On resetting histograms and diagrams, the data for short-term monitoring are also reset.

Monitoring

- Resetting measured data does not cause the diagnostic parameters and reference value to be reset as well.
- The positioner does not need to be re-initialized after resetting.

Reset measured diagnostic data

Code 36 - Diag

- Parameters are reset as described in ► Section 17.4.
- Resets diagnostics assessment.
- Reference values remain unchanged.
- Status classification and data logs remain saved.
- The positioner does not need to be re-initialized after resetting.
- If the diagnostic data are to be reset at regular intervals, enter the time in "Desired time until 'Reset measured diagnostic data" (Code 48 - h3). The setting "00:00:00" causes the resetting at regular intervals to be deactivated.

Reset start-up parameters

Code 36 - Std

- Parameters are reset as described in ► Section 17.4.
- Resets diagnostics assessment.
- Reference values are deleted.
- Status classification remains unchanged.
- Data logs are reset.
- The positioner must be re-initialized after resetting.

Reset to default settings

Code 36 - DS

- Parameters are reset as described in ► Section 17.4.
- Resets diagnostics assessment.
- Reference values are deleted.
- Status classification and data logs are deleted.
- The positioner must be re-initialized after resetting.

i Note

Before mounting the positioner on a new control valve, perform a reset by selecting the command 'Reset to default settings' (Code 36 - DS) and re-initialize the positioner.

Table 2: Resetting the diagnosis

			Resetting single status messages	Code 36		
				Diag	Std	DS
Reference graphs	Valve signature		NO	NO	YES	YES
	Leakage sensor	Manufacturer reference	YES	NO	YES	YES
		Process reference	YES	NO	YES	YES
Data logger	Configuration and measured values		NO	YES	YES	YES
Valve signature	Signal pressure(x)	Measured values	YES	YES	YES	YES
	Course of supply pressure	Configuration	NO	NO	YES	YES
		Measured values	YES	YES	YES	YES
	Friction(x)	Measured values	YES	YES	YES	YES
On/off valve	Configuration		YES	NO	YES	YES
	Measured values		YES	YES	YES	YES
Valve position x histogram		Measured values	YES	YES	YES	YES
	Short-term monitoring	'Sampling time' and measured values	YES	YES	YES	YES
Set point deviation e histogram		Measured values	YES	YES	YES	YES
	Short-term monitoring	'Sampling time' and measured values	YES	YES	YES	YES
Cycle counter histogram		Measured values	YES	YES	YES	YES
	Short-term monitoring	Measured values	YES	YES	YES	YES
Leakage sensor	Short-term monitoring	'Sensitivity sound level' and measured values	YES	YES	YES	YES
	Long-term monitoring	Measured values	YES	YES	YES	YES
	Sound level(x)	Measured values	YES	YES	YES	YES
Course of lower end position		Measured values	YES	YES	YES	YES
		Reference value	YES	NO	YES	YES
Valve dead band		Configuration and measured values	YES	YES	YES	YES
Partial stroke test (PST)		Configuration and measured values	YES	NO*	YES	YES

* Except for 'Sampling time' parameter

Monitoring

	Resetting single status messages	Code 36			
		Diag	Std	DS	
Full stroke test (FST)	Configuration and measured values	YES	NO*	YES	YES
* Except for 'Sampling time' and 'Max. test duration' parameters					
Alarm settings	NO	See ► Sec. 17.4			
Status classification according to NAMUR 107	NO	NO	NO	YES	
All logged messages, see ► Section 2.2	YES	NO	YES	YES	
Operating hours counter	NO	NO	NO	NO	
Device in operation	NO	NO	YES	YES	
Device switched on since initialization	NO	NO	YES	YES	
Device in operation since initialization	NO	NO	YES	YES	

2.1.2 Condensed state

To provide a better overview on the condition of the positioner, all status messages are summarized in a condensed state which is made up from a summary of all classified messages in the positioner. The status message with the highest priority determines which condensed state is set.

The condensed state appears in TROVIS-VIEW 4 on the right-hand side of the info bar and in the **Measured process values** folder. See ► Table 3 for a description of the icons and their meaning.

Additionally, the condensed state can be used to trigger the data logger. See ► Section 3.2.1.

i Note

The condensed state is marked by  until the positioner data have been uploaded.









The condensed state can be read in the positioner display in Code 48 - d6. See ► Table 3.

Condensed state at the fault alarm output

The condensed state also be read out at the fault alarm output if one of the following conditions occurs:

1. Condensed state 'Failure' is activated.
2. Condensed state 'Function check' is activated and the fault alarm output is activated.
3. Condensed state 'Maintenance required' or 'Out of specification' is activated and the fault alarm output is activated.

Table 3: Condensed state reading

Status message	TROVIS-VIEW 4/DTM	Positioner	Priority
Failure	 red		
Function check	 orange	Text e.g. TESTING, TUNE or TEST	
Out of specification	 yellow	 blinking	
Maintenance request/ maintenance required	 blue		
No message, OK	 green		

Device settings > Alarm settings

2. – Fault alarm at condensed state 'Function check' (Code 32): **Yes**
3. – Error message in case of 'Maintenance required' and 'Out of specification' condensed states (Code 33): **Yes**

2.2 Logging

The last 30 generated messages are saved in the positioner with a time-stamp (logged by the operating hours counter) and with details on how long the message exists.

You can view these messages in TROVIS-VIEW 4 in the **Diagnostics** folder (> Monitoring > Logging).

Logging starts automatically 15 minutes after initialization. It does not need to be activated by the user.

Messages are logged when:

- Their status classification is not 'No message'.
- Their recording in the logging is activated.
- The 'Internal solenoid valve/forced venting/supply pressure' message is only additionally logged when the time entered in 'Min. interval for new logging of internal solenoid valve' has elapsed between the generation of two 'Internal solenoid valve/forced venting/supply pressure' messages.

i Note

Logging can only be deactivated when the associated status classification is set to 'No message'.

Device settings > Alarm settings > Status classification > Logging

- Supply pressure: [Yes], No
- Change in friction: [Yes], No
- Seat leakage: [Yes], No
- Packing leakage: [Yes], No
- Pneumatic leakage: [Yes], No
- Defective actuator springs: [Yes], No
- Manipulated variable range limitation: [Yes], No
- Course of end position: [Yes], No
- Positioner-valve linkage: [Yes], No
- Manipulated variable range: [Yes], No
- Change in manipulated variable range: [Yes], No
- Partial stroke test (PST) [Yes], No
- Full stroke test (FST): [Yes], No
- On/off valve: [Yes], No
- Code 50-58, 61, 63, 76, 81: [Yes], No
- Binary input: [Yes], No
- Data logger: [Yes], No
- Internal solenoid valve/forced venting/supply pressure: [Yes], No
- Min. interval for new logging of internal solenoid valve: 0 to 5000 s, [300 s]

The following messages are not logged if they are generated due to a hardware error:

- Packing leakage
- Pneumatic leakage
- Manipulated variable range limitation
- Course of end position
- Positioner-valve linkage
- Manipulated variable range
- Change in manipulated variable range

In this case, only the original hardware error is logged:

- $x >$ range (Code 50)
- Internal solenoid valve/forced venting/supply pressure (Code 54)
- Transit time not reached (Code 55)
- Inconsistent data memory (Code 59)
- Internal device error (Code 60)
- x signal (Code 62)
- i/p converter (Code 64)
- Hardware (Code 65)

Data logger

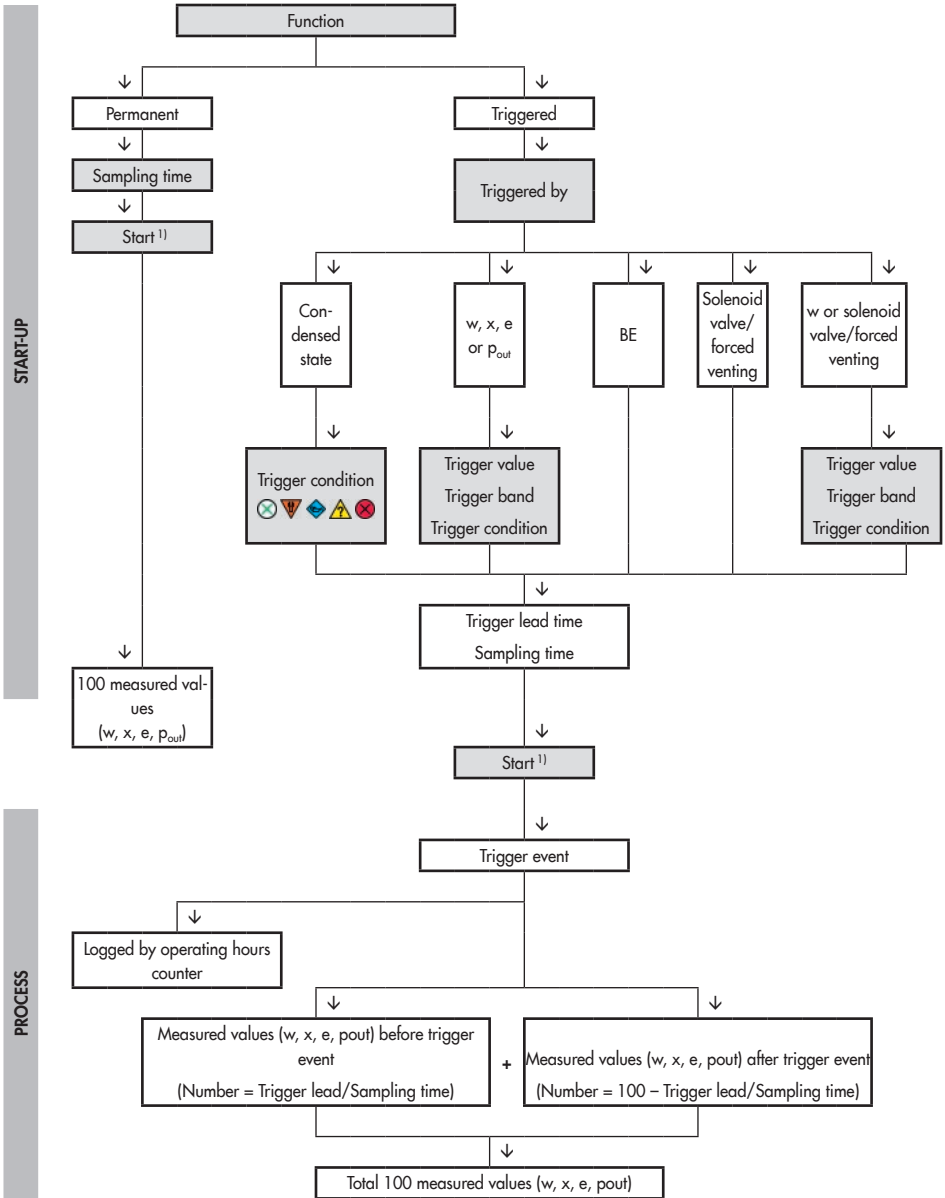

¹⁾ The data logger is started by the software, e.g. TROVIS-VIEW 4

3 Data logger

The data logger records the measured variables (valve position x , set point w , set point deviation e and signal pressure p_{out}). The recorded data are plotted against time in a graph.

i Note

The data logger is interrupted and must be reactivated when one of the following events occurs:

- Failure of power supply of the positioner
- Failure of power supply of the external solenoid valve

3.1 Permanent data logging

The measured variables are logged at the rate defined in 'Sampling time' and saved in a circular buffer, which holds 100 data points per measured variable at one time.

i Note

You can read the measured data logged over the past 24 hours from the 'Data logger' graph when the **Diagnostics** folder (> Data logger) is left open over this period.

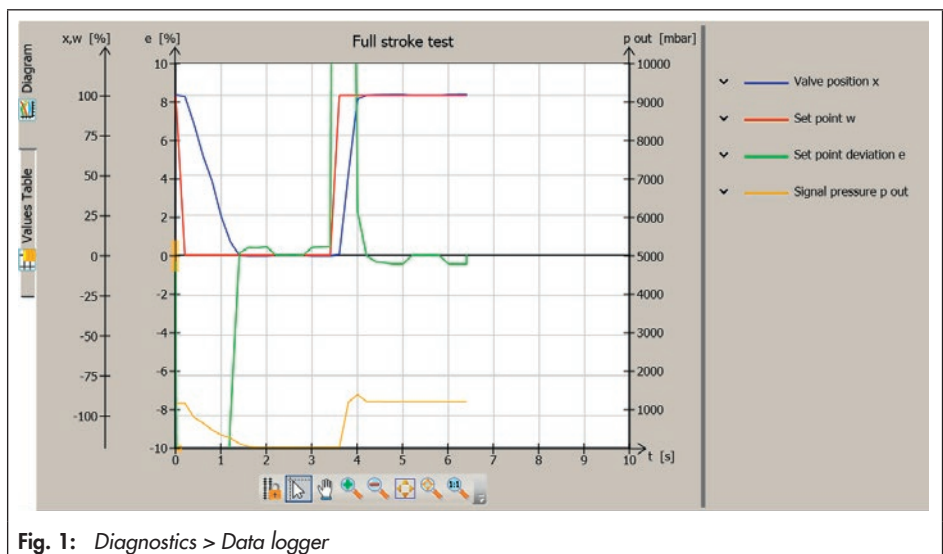

Fig. 1: Diagnostics > Data logger

Data logger

Defining parameters

1. Select 'Permanent' (Function).
2. Enter sampling time.
3. Start data logger.
The 'Test information' status indicates 'Test active'.

Diagnostics > Data logger

1. – Function: **[Permanent]**
2. – Sampling time: 0.2 to 3600.0 s, [1.0 s]
3. – Start data logger

Note

Right-click 'Cancel data logger' and select 'Execute' to stop the data logger ('Test information' = 'Test not active').

3.2 Triggered data logging

Measured values are saved in a circular buffer after the event defined in 'Triggered by' has occurred (see ► Section 3.2.1 to 3.2.5). The event that has triggered data logging is recorded. Data logging is terminated after 100 measured values per measured variable have been saved in the circular buffer. The 'Sampling time' determines the time between recordings. A 'Trigger lead time' greater than 0 also leads to the measuring values before the triggering event for the time selected being included in the 100 measured values per measured variable. The 'Trigger lead time' may include the value 100 x 'Sampling time' at the maximum.

Defining parameters

1. Select 'Triggered' (Function).
2. Select the triggering event.
3. Enter sampling time.
4. Start data logger.
The 'Test information' status indicates 'Test active'.
When the data logging is finished, the Progress bar indicates 'Memory full, data recording completed'.

Note:

Right-click 'Cancel data logger' and select 'Execute' to stop the data logger ('Test information' = 'Test not active').

3.2.1 Triggered by condensed state

The measured values are included in the triggered event when the condensed state defined in 'Triggered by condensed state' arises.

Note

If 'Function check' is selected as the condensed state ('Triggered by condensed state'), data are logged when a dynamic test starts. Data from each test start are logged.

Diagnostics > Data logger

1. – Function: **Triggered.**
2. – Sampling time: 0.2 to 3600.0 s, [1.0 s]
3. – Triggered by: **Condensed state**

- Trigger lead time:
0.0 s to 100 x 'Sampling time', [20.0 s]
- Triggered by condensed state: No message, Function check [Maintenance required], Maintenance demanded, Out of specification, Failure

4. - Start data logger

3.2.2 Triggered by set point, valve position, set point deviation or signal pressure

The measured values are included in the triggered data logging when the conditions for the selected measured variable (set point w , valve position x , set point deviation e or signal pressure p_{out}) defined in 'Trigger value', 'Trigger band' and 'Trigger condition' are met.

'Trigger condition' = Decreasing signal/ lower band value undercut

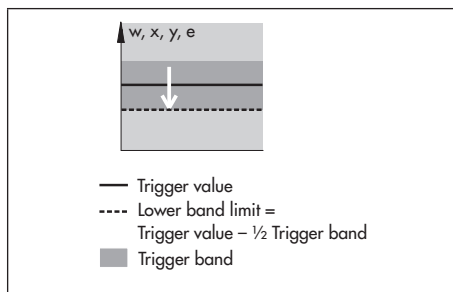

The conditions for starting a trigger event are met when the value falls below the limit ('Trigger value' - 1/2 'Trigger band').

'Trigger condition' = Increasing signal/ upper band value exceeded

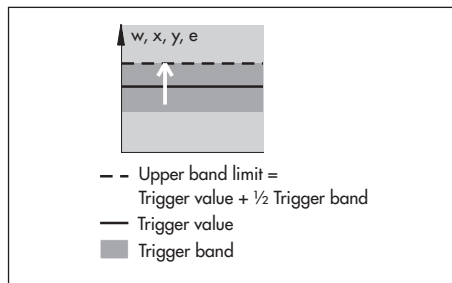

The conditions for starting a trigger event are met when the value falls below the limit ('Trigger value' - 1/2 'Trigger band').

'Trigger condition' = Band exit

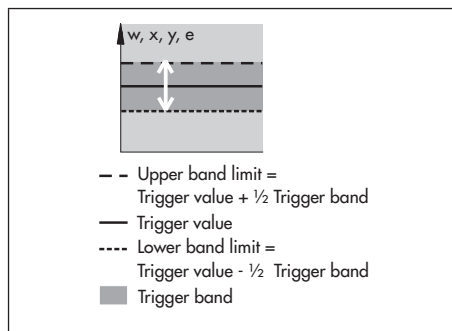

The conditions for starting a trigger event are met when the value falls below the limit ('Trigger value' - 1/2 'Trigger band') or exceeds the limit ('Trigger value' + 1/2 'Trigger band').

This function is only active when 'Trigger band' $\neq 0$.

'Trigger condition' = Band entry

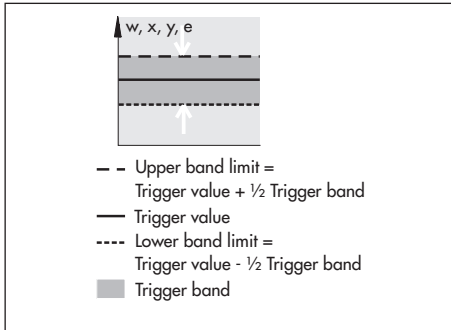

The conditions for starting a trigger event are met when the value exceeds the limit ('Trigger value' - 1/2 'Trigger band') or falls below the limit ('Trigger value' + 1/2 'Trigger band').

This function is only active when 'Trigger band' \neq 0.

Diagnostics > Data logger

1. – Function: **Triggered**
2. – Triggered by: Valve position, set point deviation, signal pressure or set point
 - Trigger value:
 0.0 to 100.0 %, [99.0 %] (set point, valve position, set point deviation)
 0.0 to 7000.0 mbar, [99.0 mbar] (signal pressure)
 - Trigger band:
 0.0 to 100.0 %, [99.0 %] (set point, valve position, set point deviation)
 0.0 to 10000.0 1/s, [99.0 1/s] (drive signal)
 - Trigger lead time:
 0.0 s to 100 x 'Sampling time', [20.0 s]

– Trigger condition: [Decreasing signal/lower band value undercut], Increasing signal/upper band value exceeded, Band exit, Band entry

3. – Sampling time: 0.2 to 3600.0 s, [1.0 s]

4. – Start data logger

3.2.3 Triggered by binary input

This setting is only active when a binary input is installed in the positioner. If this is not the case, the Progress bar indicates 'Cannot start data logger – trigger cannot be set'.

The measured values are included in the triggered data logging when the state of the binary input changes.

Diagnostics > Data logger

1. – Function: **Triggered**
2. – Triggered by: **Binary input**
 - Trigger lead time:
 0.0 s to 100 x 'Sampling time', [20.0 s]
3. – Sampling time: 0.2 to 3600.0 s, [1.0 s]
4. – Start data logger

3.2.4 Triggered by internal solenoid valve/forced venting

This setting is only active when an internal solenoid valve/forced venting is installed in the positioner. See 'Internal solenoid valve/forced venting' reading. If this is not the case, the Progress bar indicates 'Cannot start data logger – trigger cannot be set'.

The measured values are included in the triggered data logging when the solenoid valve is triggered or the forced venting is activated.

Diagnosics > Data logger
1. – Function: Triggered
2. – Triggered by: Internal solenoid valve/forced venting – Trigger lead time: 0.0 s to 100 x 'Sampling time', [20.0 s]
3. – Sampling time: 0.2 to 3600.0 s, [1.0 s]
4. – Start data logger

3.2.5 Triggered by set point or internal solenoid valve/forced venting

This setting is only active when an internal solenoid valve/forced venting is installed in the positioner. See 'Internal solenoid valve/forced venting' reading. If this is not the case, the Progress bar indicates 'Cannot start data logger – trigger cannot be set'.

The measured values are included in the triggered data logging when one of the condi-

tions defined in 'Triggered by internal solenoid valve/forced venting' or 'Triggered by set point' are met.

Diagnosics > Data logger
1. – Function: Triggered – Triggered by: Set point or internal solenoid valve/forced venting – Trigger value: 0.0 to 100.0 %, [99.0 %] – Trigger band: 0.0 to 100.0 %, [99.0 %] – Trigger lead time: 0.0 s to 100 x 'Sampling time', [1.0 s] – Trigger condition: [Decreasing signal/lower band value undercut], Increasing signal/upper band value exceeded, Band exit, Band entry
3. – Sampling time: 0.2 to 3600.0 s, [20.0 s]
4. – Start data logger

Valve signature

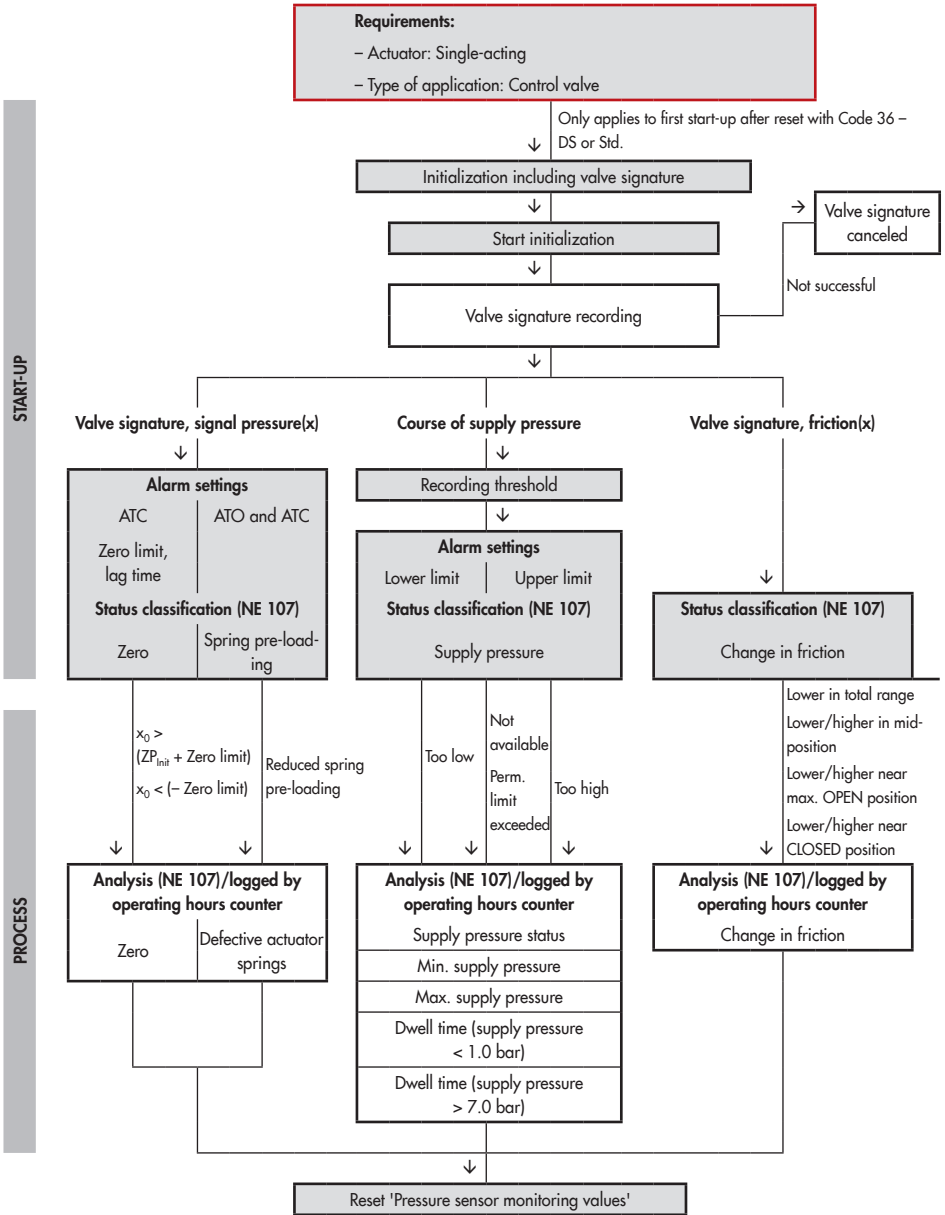

4 Valve signature

The valve signature plots the signal pressure p_{out} as a function of valve position x .

All diagnostic functions dependent on the signal pressure are based on the valve signature, e.g. to detect pneumatic leakage or to reveal an excessively high or low supply pressure.

i Note

Additionally, the pneumatics are monitored using the 'Leakage limit' parameter, which is adjustable between 0 and 100 % in the **Device settings** folder (> Alarm settings). The positioner generates the 'Pneumatic leakage' message whenever the leakage exceeds this limit value. 'No message' is assigned by default.

Requirements

1. A single-acting actuator is mounted on the valve.
2. The valve operates as a control valve.

Device settings > Actuator

1. – Principle of operation (Code 48 - d11):
Single-acting

Start-up

2. – Type of application (Code 49 - h0):
Control valve

To perform monitoring while the process is running, the reference graph must first be plotted.

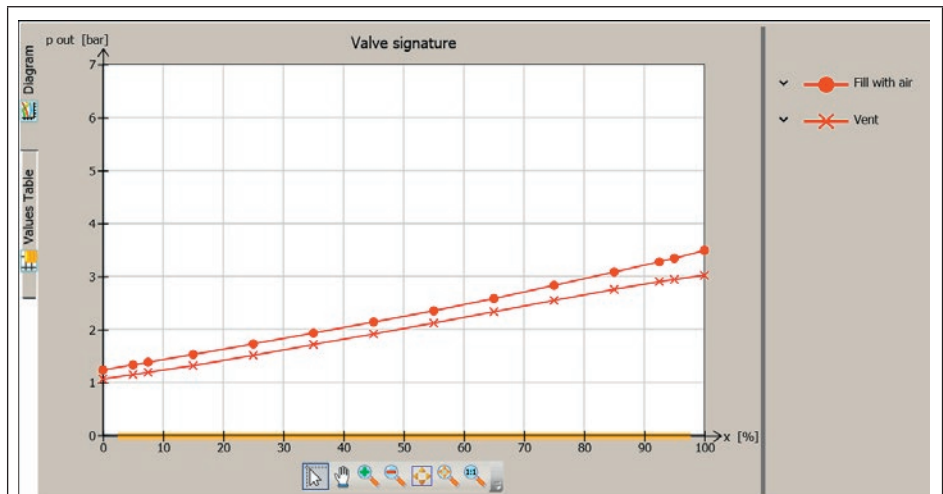

Fig. 2: Start-up > Reference graphs > Valve signature

4.1 Reference graphs

During the plotting of the reference graph (Fig. 2), the valve is moved very slowly from the end position at which no pressure is applied to the actuator to the position at which the maximum air signal is applied to the actuator. The valve is then moved back again to its end position. During which, the positioner switches to open-loop control (control without feedback).

The sensitivity of reference graph plotting defines at which speed the valve is moved. The time span how long the reference graph is to be plotted depends on the sensitivity selected. Select 'High' for valves with small bench ranges and/or high friction.

After the reference graph has been plotted, the recorded data points for signal pressure p_{out} and valve position x are converted into fixed points.

i Note

The valve positions cannot be predicted in open-loop control (control without feedback). The reference graph may differ for the same valve after each logging.

Defining parameters

The reference graph is automatically plotted after initialization when 'Initialization including valve signature' = Yes.

Start-up

– Initialization including valve signature (Code 48 - h0): [Yes]

The reference graph can also be plotted separately outside initialization.

1. Switch to manual mode.
2. Select 'Sensitivity' from the drop-down list.
3. Start test.

The 'Test information' status indicates 'Test active'. 'D1' and 'TEST' are indicated in alternating sequence on the positioner display.

'Function check'  is activated as the condensed state.

Start-up

1. – Enter operating mode (Code 0): Manual

Start-up > Reference graphs > Valve signature

2. – Sensitivity: Low, [Medium], High
3. – Start test

4.1.1 Analysis and monitoring

The positioner records the data for filling and venting the actuator. It then determines the characteristic values listed below:

- 'Mean hysteresis': Average hysteresis (average signal pressure change Δp_{out} in relation to the spring range)
- 'Min. hysteresis': Lowest possible hysteresis (minimum signal pressure change Δp_{out} in relation to the spring range)
- 'Max. hysteresis': Highest possible hysteresis (maximum signal pressure change Δp_{out} in relation to the spring range)

- 'Detected lower spring range value': Signal pressure p_{out} when the actuator is filled with the minimum amount of air
- 'Detected upper spring range value': Signal pressure p_{out} when the actuator is filled with the maximum amount of air

The 'Valve signature canceled' message is generated if the test is canceled.

Start-up > Initialization result

– Valve signature canceled (Code 81):



The 'Test status' reading indicates the reason why the test was canceled:

- No supply pressure: The supply pressure was under 500 mbar during the test.
- Valve moved too quickly. Recommended action: Increase sensitivity
- Position at p_{max} not reached (filling with air):
 - (1) Even though the pressure was increased in steps from 0 bar to the maximum amount of air for filling the actuator, the valve was not able to reach the maximum position in closed-loop operation.
 - (2) The minimum valve position without tight-closing is below 96 %. Recommended action: Increase supply pressure.
- Position at p_{min} not reached (venting):
 - (1) Even though the pressure was reduced in steps from the maximum amount of air for filling the actuator, the valve was not able to reach the minimum

position in closed-loop operation. The valve might be jammed.

(2) The minimum valve position without tight-closing is above 4 %.

- Time-out
- Double-acting actuator
- Internal error
- Current too low
- Internal solenoid valve/forced venting triggered
- SUB initialization

4.2 Valve signature, signal pressure(x)

The positioner records the data for filling and venting the actuator during closed-loop operation. The recorded data can be directly compared with the reference graph. Additionally, the minimum, maximum and current supply pressure are shown in the graph.

Data are recorded in the background regardless of the operating mode selected **if a reference graph has already been plotted**. Data logging does not need to be activated.

i Note

The positioner determines the minimum and maximum supply pressure while plotting the reference graph. The current supply pressure may fall below the minimum supply pressure and exceed the maximum supply pressure.

Defining parameters

1. Record reference graph. ► Section 4.2.

Valve signature

2. Set the limit for zero monitoring in control valves with closed position ATC (air to close) to close).
3. Select classification for status messages. See ► Section 4.2.1.

Device settings > Alarm settings

2. – Zero limit (Code 48 - d5):
0.0 to 100.0 %, [5.0 %]
– Lag time: 1 to 9999 s, [30 s]

Device settings > Alarm settings > Status classification > Positioner

3. – Zero (Code 58): [⊗], [⊕], [⊗], [⚠]

Device settings > Alarm settings > Status classification > Actuator

Defective actuator springs

- Reduced spring pre-loading: [⊗], [⊕], [⊗], [⚠]

4.2.1 Analysis and monitoring

If the monitoring line has a smaller gradient than the reference line, this pinpoints to a reduced compression of the actuator springs.

Diagnostics > Monitoring > Actuator

- Defective actuator springs: [✓], [⊕], [⊗], [⚠]

Valves with ATC (air to close) closed position

In valves with ATC closed position, the positioner generates a zero error when the valve position in the tight-closing position is larger than the sum of the initialization zero points and 'Zero limit' or smaller than the negative 'Zero limit' after the adjusted 'Lag time' has elapsed.

Diagnostics > Monitoring > Positioner

- Zero (Code 58): [✓], [⊕], [⊗], [⚠]

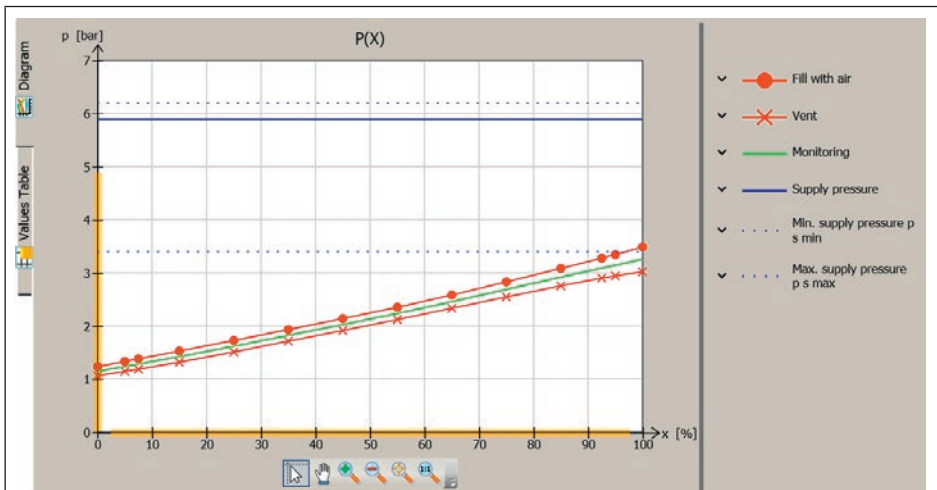

Fig. 3: Diagnostics > Monitoring/tests > Valve signature > Valve signature, signal pressure(x)

4.3 Course of supply pressure

During control-loop operation, five values of the supply pressure are recorded and saved in a circular buffer. A new supply pressure is recorded and saved in the circular buffer when it deviates from the last value plotted in the graph by the amount entered in 'Recording threshold'.

Data are recorded in the background regardless of the operating mode selected. Data logging does not need to be activated. To monitor the limits ('Lower limit' and 'Upper limit'), the corresponding limit must be activated first. The limits are automatically determined while the valve signature is being plotted. Alternatively, user-defined limits can be entered.

Defining parameters

1. Define 'Recording threshold'.
2. Enter limits for monitoring. See ► Section 4.3.1.
3. Select classification for status messages. See ► Section 4.3.1.

Diagnostics > Monitoring/tests > Valve signature > Course of supply pressure

1. – Recording threshold:
0.10 to 14.00 bar, [0.50 bar]

Device settings > Alarm settings

2. – Activate lower limit: [Yes, No]
– Lower limit: [0.0] to 7.0 bar
– Activate upper limit: Yes, [No]
– Upper limit: [0.0] to 7.0 bar

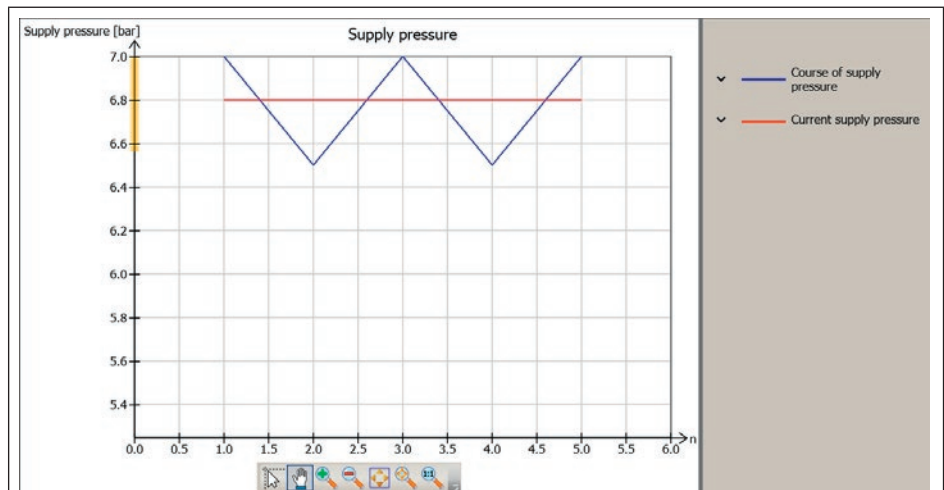

Fig. 4: Diagnostics > Monitoring/tests > Valve signature > Course of supply pressure

Device settings > Alarm settings > Status classification > Supply pressure

3. – Permissible limit exceeded:



– Too high: , , ,

– Fluctuates: , , ,

– Too low: , , ,

– Not available: , , ,

- Min. supply pressure
- Time stamp of min. supply pressure
- Max. supply pressure
- Time stamp of max. supply pressure
- Dwell time (supply pressure < 1.0 bar)
- Dwell time (supply pressure > 7.0 bar)

4.3.1 Analysis and monitoring

The positioner generates the 'Supply pressure status' message with the defined status classification.

- 'Too high' if the supply pressure exceeds the 'Upper limit'.
- 'Not available' if the supply pressure falls below 0.1 bar.
- 'Too low' if the supply pressure exceeds the 'Lower limit'.
- 'Permissible limit exceeded' if the supply pressure exceeds 7.0 bar.

A fluctuating supply pressure is recognized by the positioner whenever the supply pressure continuously falls below the 'Lower limit' and rises above the 'Upper limit'. In such cases, the positioner generates the 'Supply pressure status' message with the defined status classification.

Diagnostics > Monitoring > Actuator

– Supply pressure status: , , ,

– Supply pressure (Code 48 - d7)

4.4 Valve signature, friction(x)

The positioner calculates the friction during closed-loop operation and compares it with the friction determined when the reference graph was plotted.

Data are recorded automatically 15 minutes after initialization (regardless of the operating mode selected) if a reference graph has already been plotted. Data logging does not need to be activated.

Defining parameters

1. Record the reference graph. See ► Section 4.1.
2. Select classification for status messages. See ► Section 4.2.1.

Device settings > Alarm settings > Status classification > Valve

2. Change in friction

- Higher in total range: [⊗], [⊕], [⊗], [⚠]
- Lower in total range: [⊗], [⊕], [⊗], [⚠]
- Higher in mid-position: [⊗], [⊕], [⊗], [⚠]
- Lower in mid-position: [⊗], [⊕], [⊗], [⚠]
- Higher near max. OPEN position: [⊗], [⊕], [⊗], [⚠]
- Lower near max. OPEN position: [⊗], [⊕], [⊗], [⚠]
- Higher near CLOSED position: [⊗], [⊕], [⊗], [⚠]
- Lower near CLOSED position: [⊗], [⊕], [⊗], [⚠]

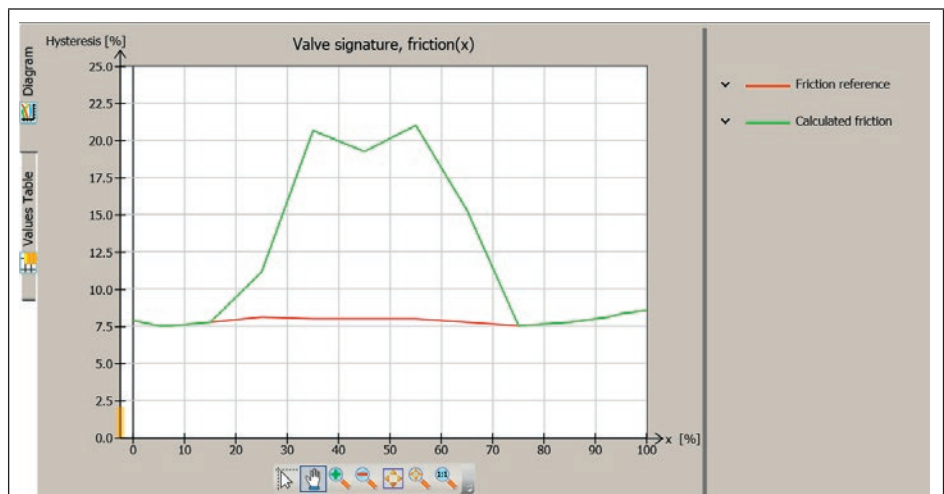

Fig. 5: Diagnostics > Monitoring/tests > Valve signature > Valve signature, friction(x)

4.4.1 Analysis and monitoring

The positioner generates the 'Change in friction' message with the selected status classification. The friction for the total range of the valve, the mid valve position and for the ranges near to the end positions are compared.

The positioner calculates the friction during closed-loop operation from the actuator filling and venting graphs at the point where a directional change in valve travel takes place. The positioner converts the friction data into fixed points close to the point of directional change and compares them to the reference friction.



If the friction at a fixed point increases to more than double of the reference friction, the friction is regarded to be higher.

If the friction at a fixed point drops to less than half of the reference friction, the friction is regarded to be lower.

i Note

To ensure that sufficient data points are available for calculating the friction, the valve must not be moved too quickly.

Diagnostics > Monitoring > Valve

– Change in friction:    

4.5 Resetting single status messages

All messages generated by the valve signature can be reset together by selecting and executing "Reset 'Pressure sensor monitoring values'". These messages include:

- Change in friction
- Supply pressure status
- Defective actuator springs
- Zero

At the same time, the supply pressure data (supply pressure, min. supply pressure and max. supply pressure) are reset as well.

Diagnostics > Service/maintenance > Reset

– Reset 'Pressure sensor monitoring values'

On/off valve

START-UP

PROCESS

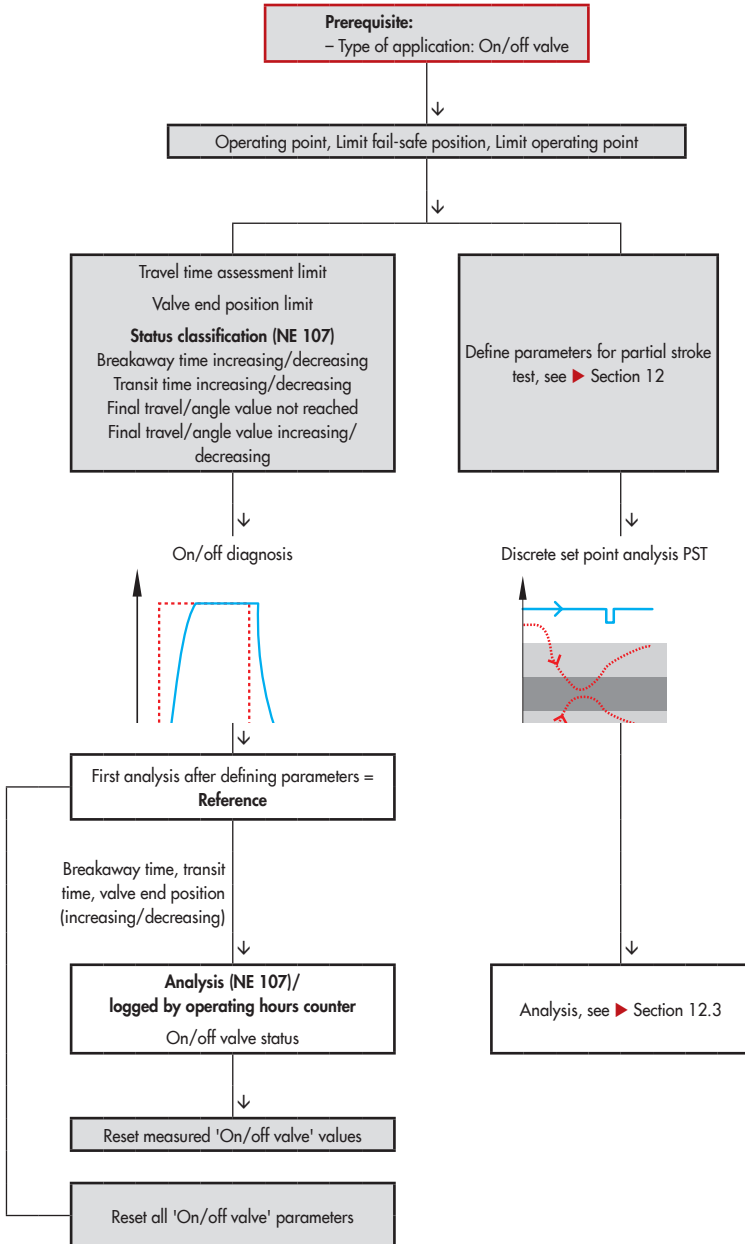

5 On/off valve

The travel range of open/close (on/off) is defined by the fail-safe position and the operating point. As a result, the following parameters to determine the working range and set point range are not analyzed and cannot be changed.

- Lower travel/angle range value
- Upper travel/angle range value
- Lower travel/angle limit
- Upper limit for travel/angle
- Lower set point range value
- Upper set point range value

The discrete analysis of the reference variable is performed in automatic mode.

If the set point (---) is below 'Operating point limit' when the automatic mode starts, the valve (—) moves to the fail-safe position. If the set point increases and exceeds 'Operating point limit', the valve moves to the 'Operating point'. The valve moves back to the fail-safe position (0 % in the example) if the set point then falls below 'Fail-safe action limit'.

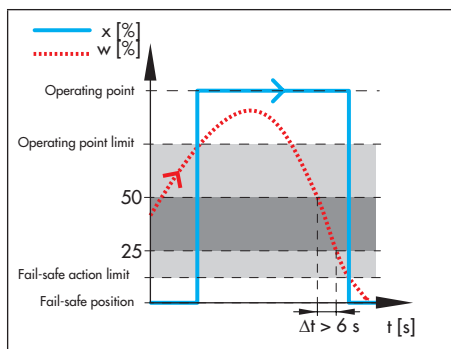

If the set point (---) is above 'Operating point limit' when the automatic mode starts, the valve (—) moves to the operating point. The valve moves back to the fail-safe position (0 % in the example) if the set point then falls below 'Fail-safe action limit'.

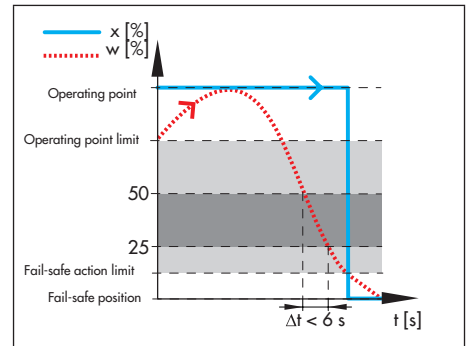

Starting the partial stroke test (PST)

A partial stroke test is started when the set point (---) moves in the range between 25 and 50 % of the travel range and remains there for longer than six seconds. See

► Section 12.1.

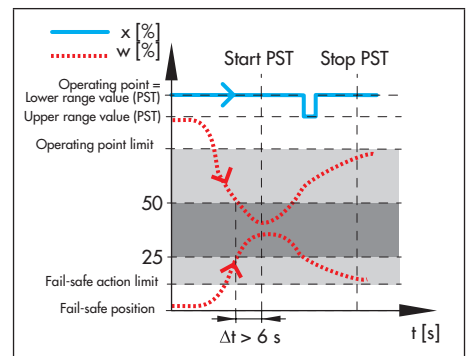

On/off valve

The PST diagnostic parameter 'Lower range value' must be within the defined position \pm 'Tolerance limit' for the partial stroke test to start.

After the partial stroke test is completed, the valve moves back to its last position (fail-safe position or operating point).

Canceling the partial stroke test (PST)

The partial stroke test is canceled whenever the set point (---) leaves the range between 'Fail-safe action limit' and 'Operating point limit', falling below 'Operating point limit'.

After the partial stroke test is canceled, the valve moves back to its last position (fail-safe position or operating point).

Defining parameters

Note

The parameters can only be defined in TROVIS-VIEW 4 after the 'Type of application' has been set to 'On/off valve'.

1. Select the type of application.
2. Define parameters for on/off valve.
3. Define parameters for partial stroke test (PST). See ► Section 12.

Start-up

1. – Type of application (Code 49 - h0): **On/off valve**

Device settings > Positioner > Transfer characteristic on/off

2. – Operating point (Code 49 - h1): 0.0 to 100 %, [100 %]

- Fail-safe action limit (Code 49 - h2): 0.0 to 20.0 %, [12.5 %]
- Operating point limit (Code 49 - h5): 55.0 to 100.0 %, [75.0 %]

Diagnostics > Monitoring/tests > Dynamic tests > Partial stroke test (PST)

3. See ► Section 12

5.1 Diagnostics for on/off valve

The diagnostics for on/off valve provide statements on the valve end positions, transit times (increasing/decreasing) and break-away times (increasing/decreasing).

The data are recorded automatically for the diagnostics for on/off valve in automatic mode. Data logging does not need to be activated.

The positioner compares the current break-away time, transit time and valve position with the values recorded during the reference measurement (first analysis) while the plant is running.

Defining parameters



Note:

The parameters can only be defined in TROVIS-VIEW 4 after the 'Type of application' has been set to 'On/off valve'.

1. Enter limits for monitoring. See ► Section 5.2.
2. Select classification for status messages.

Device settings > Alarm settings

- Travel time assessment limit (Code 49 - h7): [0.6] to 30.0 s
– Valve end position limit (Code 49 - h8): [0.3] to 100.0 %

Device settings > Alarm settings > Status classification > On/off valve

- Increasing breakaway time: [⊗], [⬇️], [⊗], [⚠️]
– Decreasing breakaway time: [⊗], [⬆️], [⊗], [⚠️]
– Transit time increasing: [⊗], [⬆️], [⊗], [⚠️]
– Transit time (decreasing): [⊗], [⬆️], [⊗], [⚠️]
– Final travel/angle value not reached: [⊗], [⬆️], [⊗], [⚠️]
– Increasing final travel/angle value: [⊗], [⬆️], [⊗], [⚠️]
– Decreasing final travel/angle value: [⊗], [⬆️], [⊗], [⚠️]

5.2 Analysis and monitoring

The analysis pinpoints to a fault when at least one of the following conditions is met while the valve is moving:

- The current 'Increasing breakaway time' differs from the reference value by the amount entered in 'Travel time assessment limit'.
- The current 'Decreasing breakaway time' differs from the reference value by the amount entered in 'Travel time assessment limit'.
- The current 'Transit time increasing' differs from the reference value by the amount entered in 'Travel time assessment limit'.

- The current 'Transit time (decreasing)' differs from the reference value by the amount entered in 'Travel time assessment limit'.
- The current 'Transit time increasing' differs from the reference value by the amount entered in 'Valve end position limit'.
- The current 'Transit time (decreasing)' differs from the reference value by the amount entered in 'Valve end position limit'.
- The valve end position is not reached.

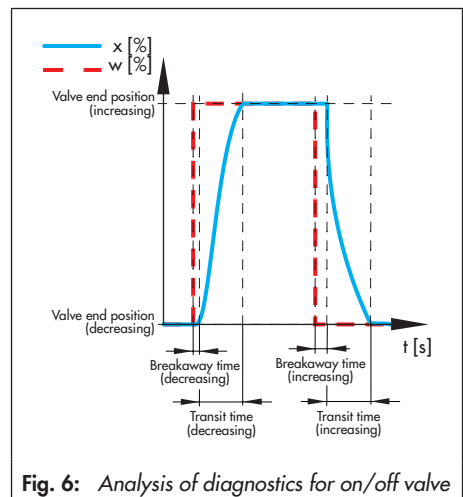

Fig. 6: Analysis of diagnostics for on/off valve

If one of these conditions is met, the positioner generates an 'On/off valve status' message according to the selected status classification.

Diagnostics > Monitoring

- On/off valve status (Code 85):



5.3 Resetting single status messages

The message and the limit values are reset by selecting and executing "Reset measured 'On/off valve' values".

The positioner saves the reference analysis and two further test analyses. The analysis of the oldest test is deleted when another test is performed.

Diagnostics > Service/maintenance > Reset

– Reset measured 'On/off valve' values

6 Valve position x histogram

The valve position histogram is a statistical analysis of the plotted valve positions. The histogram provides information about where the valve mainly spends the majority of its time during its service life and whether it shows a recent trend concerning changes in its operating range.

Data are recorded automatically 15 minutes after initialization (regardless of the operating mode selected). Data logging does not need to be activated.

The positioner records the valve position every second and assigns the data into pre-defined valve position classes. The distribution showing how often the sound level occurred within a valve position class is shown in a bar graph.

- 'Mean value': Average class assignment of valve positions throughout 'Monitoring duration'.

- 'Number of measurement points': Total number of values recorded during the 'Monitoring duration'.

- 'Monitoring duration'

The measured data are saved every 24 hours in the positioner.

Short-term monitoring

In order to be able to recognize any short-term changes in valve position, the positioner records the valve positions according to the adjusted 'Sampling time' and analyses the last 100 measured values.

- 'Mean time': Contains the average class assignment of valve positions for the last 100 measured values.
- 'Adjusted monitoring duration': $100 \times$ 'Sampling time'

The positioner saves the valve positions in a circular buffer, which holds 100 measured values at one time.

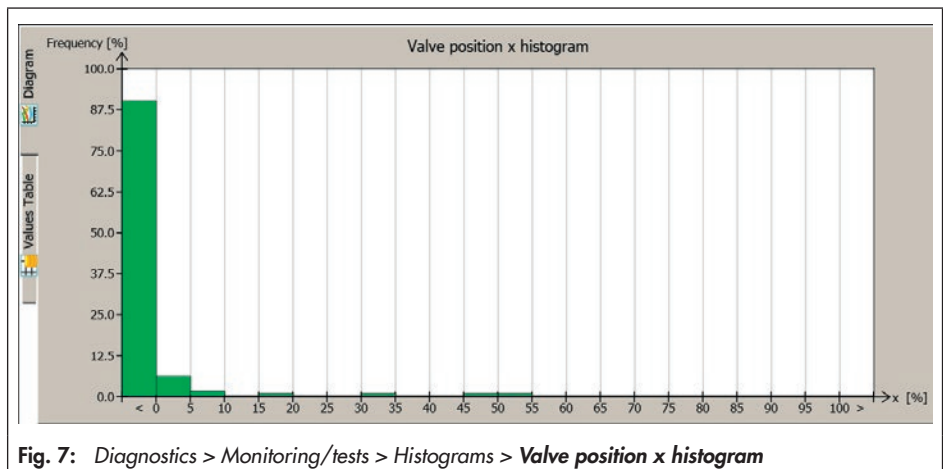

Fig. 7: Diagnostics > Monitoring/tests > Histograms > Valve position x histogram

i Note

Changing 'Sampling time' causes all existing measured values to be deleted from the circular buffer.













Defining parameters

1. Set the 'Sampling time' for the short-term monitoring.
2. Select classification for status messages. See ► Section 6.1.









Diagnostics > Monitoring/tests > Histograms > Valve position x histogram > Short-term monitoring

1. – Sampling time: Adjustable as required, [00:14:24 d.h:min:s]

Device settings > Alarm settings > Status classification > Valve position

2. Manipulated variable range
 - Mainly near CLOSED position: [⊗], , , 
 - Mainly near max. OPEN position: [⊗], , , 
 - Mainly in CLOSED position: [⊗], , , 
 - Mainly near max. OPEN position: [⊗], , , 

Change in manipulated variable range:

- Operating range shifted to CLOSED position: [⊗], , , 
- Operating range shifted to max. OPEN position: [⊗], , , 
- Short-term change: [⊗], , , 

6.1 Analysis and monitoring









Analysis of the histogram for control valves starts one hour after the monitoring period begins. No analysis is performed for on/off valves.

If the control valve mainly works during the monitoring duration near or in one of the end positions, the positioner generates the 'Manipulated variable range' message with the selected status classification.

For analysis of the short-term monitoring, a complete set of data (100 measured values) is required. The analysis is only active when the sampling time setting is greater or equal to one minute.

The positioner generates the 'Change in manipulated variable range' message with the selected status classification whenever a trend showing a change in the operating range is found from the analysis of the histogram and the short-term monitoring.

Diagnostics > Monitoring > Valve position

- Manipulated variable range: , , , 
- Change in manipulated variable range: , , , 

6.2 Resetting single status messages

The 'Manipulated variable range' and the 'Change in manipulated variable range' messages can be reset by selecting and executing the command "Reset 'Reset valve position x histogram'". This command resets all diagnostic parameters and measured data

of the histogram and the short-term monitoring.

By selecting and executing the command "Reset 'Short-term valve position x histogram", the diagnostic parameters and measured data in the **Short-term monitoring** folder are reset.

Diagnostics > Service/maintenance > Reset

- Reset 'Valve position x histogram'
- Reset 'Short-term valve position x histogram'

7 Set point deviation e histogram

The set point deviation histogram contains a statistical analysis of any set point deviations recorded. It provides information on to which extent a set point deviation has occurred during the valve service life and whether faults may occur due to a restricted operating range or due to seat leakage.

Data are recorded automatically 15 minutes after initialization (regardless of the operating mode selected). Data logging does not need to be activated.

The positioner records the set point deviation every second and assigns the data into pre-defined classes. The distribution showing how often the set point deviation remained within a class is shown in a bar graph.

- 'Mean value': Average class assignment of set point deviation throughout 'Monitoring duration'.

- 'Number of measurement points': Total number of values recorded during the 'Monitoring duration'.
- 'Monitoring duration'

The measured data are saved every 24 hours in the positioner.

Short-term monitoring

In order to be able to recognize any short-term changes in set point deviation, the positioner records the set point deviation according to the adjusted 'Sampling time' and analyses the last 100 measured values.

- 'Mean time': Contains the average class assignment of set point deviations for the last 100 measured values.
- 'Adjusted monitoring duration': $100 \times$ 'Sampling time'

The positioner saves the set point deviations in a circular buffer, which holds 100 measured values at one time.

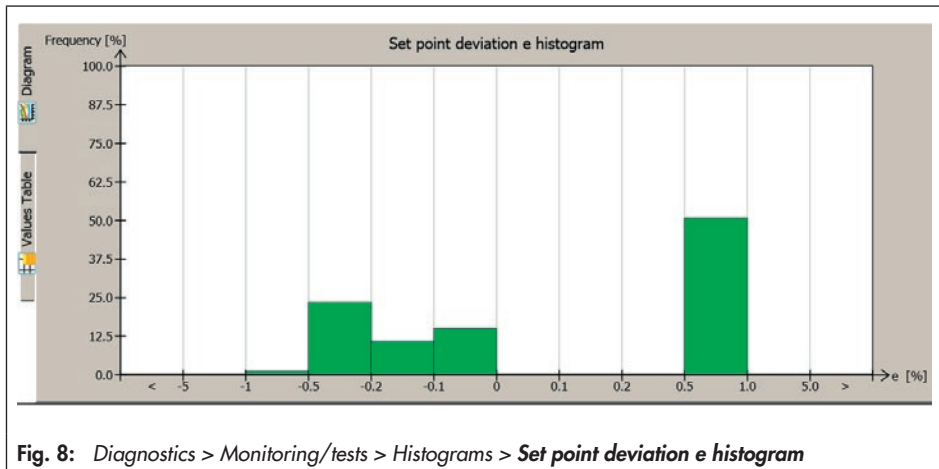

Fig. 8: Diagnostics > Monitoring/tests > Histograms > Set point deviation e histogram

i Note

Changing 'Sampling time' causes all existing measured values to be deleted from the circular buffer.

Defining parameters

1. Set the 'Sampling time' for the short-term monitoring.
2. Select classification for status messages. See ► Section 7.1.

Diagnostics > Monitoring/tests > Histograms > Set point deviation e histogram > Short-term monitoring













1. – Sampling time: Adjustable as required, [00:14:24 d.h:min:s]

Device settings > Alarm settings > Status classification > Valve

2. Seat leakage
– May exist: , , , 

Device settings > Alarm settings > Status classification > Valve position

Manipulated variable range limitation

- Lower: , , , 
- Upper: , , , 
- No change possible: , , , 

Positioner-valve linkage

- Travel transmission not optimal: , , , 

7.1 Analysis and monitoring





Ideally, the set point deviation should be nearly 0 %.

Set point deviations greater than 1 % following in quick succession pinpoint to a limitation of the upper operating range. In this case, the positioner generates the 'Manipulated variable range limitation' and 'Positioner-valve linkage' messages with the selected status classifications.









Set point deviations smaller than 1 % following in quick succession pinpoint to a limitation of the lower operating range or to seat leakage. The positioner generates the 'Manipulated variable range limitation', 'Positioner-valve linkage' and 'Seat leakage' messages with the selected status classifications.

If almost all set point deviations during the short-term monitoring are greater than 1 % or smaller than –1 %, this may indicate that the actuator or valve stem is jammed. The positioner generates the 'Manipulated variable range limitation' and 'Positioner-valve linkage' messages with the selected status classifications.

Diagnostics > Monitoring > Valve

- Seat leakage: , , , 

Diagnostics > Monitoring > Valve position

- Manipulated variable range limitation: , , , 
- Positioner-valve linkage: , , , 

7.2 Resetting single status messages

The 'Seat leakage', 'Manipulated variable range limitation' and 'Positioner-valve linkage' messages can be reset by selecting and executing the command "Reset 'Set point deviation e histogram" or "Reset 'Short-term set point deviation e histogram".

By selecting and executing the "Reset 'Set point deviation e histogram" command, all diagnostic parameters and measured data of the histogram and the short-term monitoring are reset.

By selecting and executing the command "Reset 'Short-term set point deviation e histogram", the diagnostic parameters and measured data in the **Short-term monitoring** folder are reset.

Diagnostics > Service/maintenance > Reset

- Reset 'Set point deviation histogram e'
- Reset 'Short-term set point deviation e histogram'

Cycle counter histogram

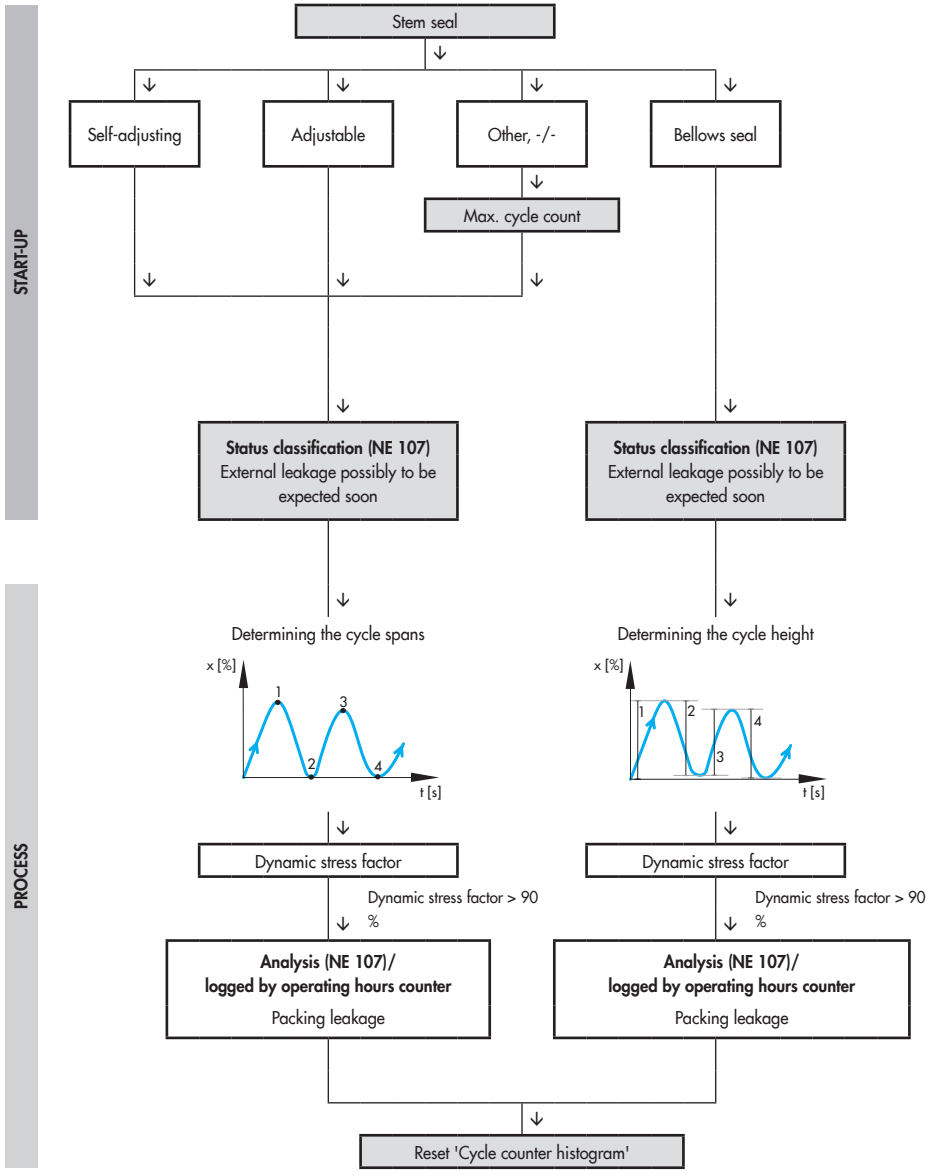

8 Cycle counter histogram

The cycle counter histogram provides a statistical analysis of the cycles. As a result, the cycle counter also provides information on the dynamic stress of a bellows seal and/or packing.

Data are recorded automatically 15 minutes after initialization (regardless of the operating mode selected). Data logging does not need to be activated.

The positioner records the number of cycle spans when the stem seal setting is set to 'Live-loaded', 'Adjustable', 'Other' or '-/-'. A valve cycle span starts at the point where the valve stroke changes direction until the point where it changes direction again. The valve stroke between these two changes in direction is the cycle span.

The positioner records the cycle height when the 'Stem seal' setting is set to 'Bellows seal'. The cycle height is the travel performed between two changes in direction.

The cycle spans or cycle heights are assigned to classes. The distribution showing how often the cycle span or height occurred within a class is shown in a bar graph.

- 'Mean value': Average class assignment of cycle height calculated from the 'No. of cycles'
- 'No. of cycles'

The measured data are saved every 24 hours in the positioner.

Defining parameters

1. Select the type of stem seal.
(*When 'Other' is selected as the stem seal, the additional parameter 'Max. cycle count' must also be set).

Device settings > Alarm settings

1. - Stem seal: [-/-], Live-loaded, Adjustable, Bellows seal, Other
- * - Max. cycle count:
1 to 100000000, [1000000]

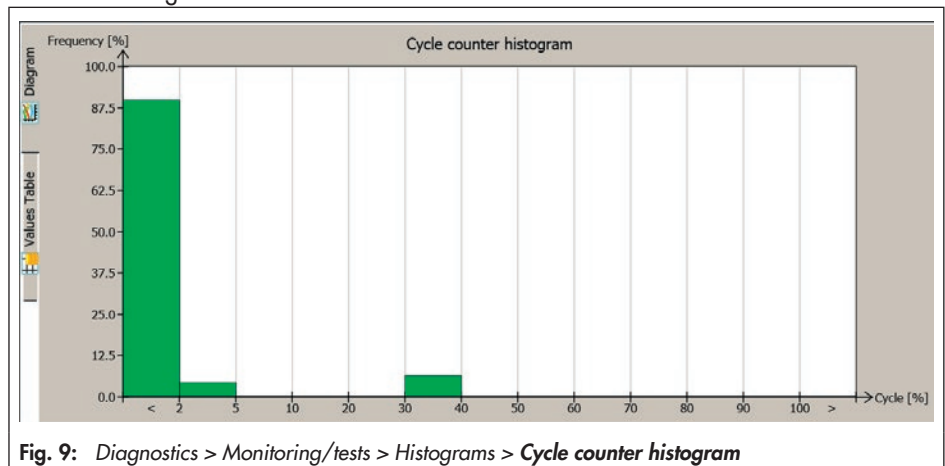

Fig. 9: Diagnostics > Monitoring/tests > Histograms > Cycle counter histogram

Cycle counter histogram

Short-term monitoring

To recognize short-term changes in the cycle spans or cycle height, the positioner analyzes the last 100 cycle heights or cycle spans.

The positioner saves the cycle heights or cycle spans in a circular buffer, which holds 100 measured values at one time.





- 'Mean time': Contains the average class assignment for the last 100 measured values.

Defining parameters

1. Select classification for status messages.

Device settings > Alarm settings > Status classification > Valve

1. Packing leakage

- Possibly to be expected soon: , , , 

8.1 Analysis and monitoring

The load on the bellows and/or packing can be read from the 'Dynamic stress factor' parameter. The value is determined from the cycle spans or cycle heights and takes into account the type of packing used in the valve.

A 'Packing leakage' message is generated with the selected status classification whenever:

- The number of measured cycle spans exceeds 450000 when 'Live-loaded' is selected as the stem seal.
- The number of measured cycle spans exceeds 180000 when 'Adjustable' is selected as the stem seal.

- The number of measured cycle spans exceeds 90 % of the 'Max. cycle count' when 'Other' is selected as the stem seal.
- The number of measured cycle heights exceeds 180000 when 'Bellows seal' is selected as the stem seal.

Measured process values

- Dynamic stress factor

Diagnostics > Monitoring > Valve

- Packing leakage: , , , 

8.2 Resetting single status messages

The 'Packing leakage' message is reset by selecting and executing the command "Reset 'Cycle counter histogram'" or "Reset 'Short-term cycle counter histogram'".

By selecting and executing the "Reset 'Cycle counter histogram'" command, all measured data of the histogram and the short-term monitoring as well as the 'Dynamic stress factor' are reset.

By selecting and executing the command "Reset 'Short-term cycle counter histogram'", the measured data in the **Short-term monitoring** folder are reset.

Diagnostics > Service/maintenance > Reset

- Reset 'Cycle counter histogram'
- Reset 'Short-term cycle counter histogram'

Leakage sensor

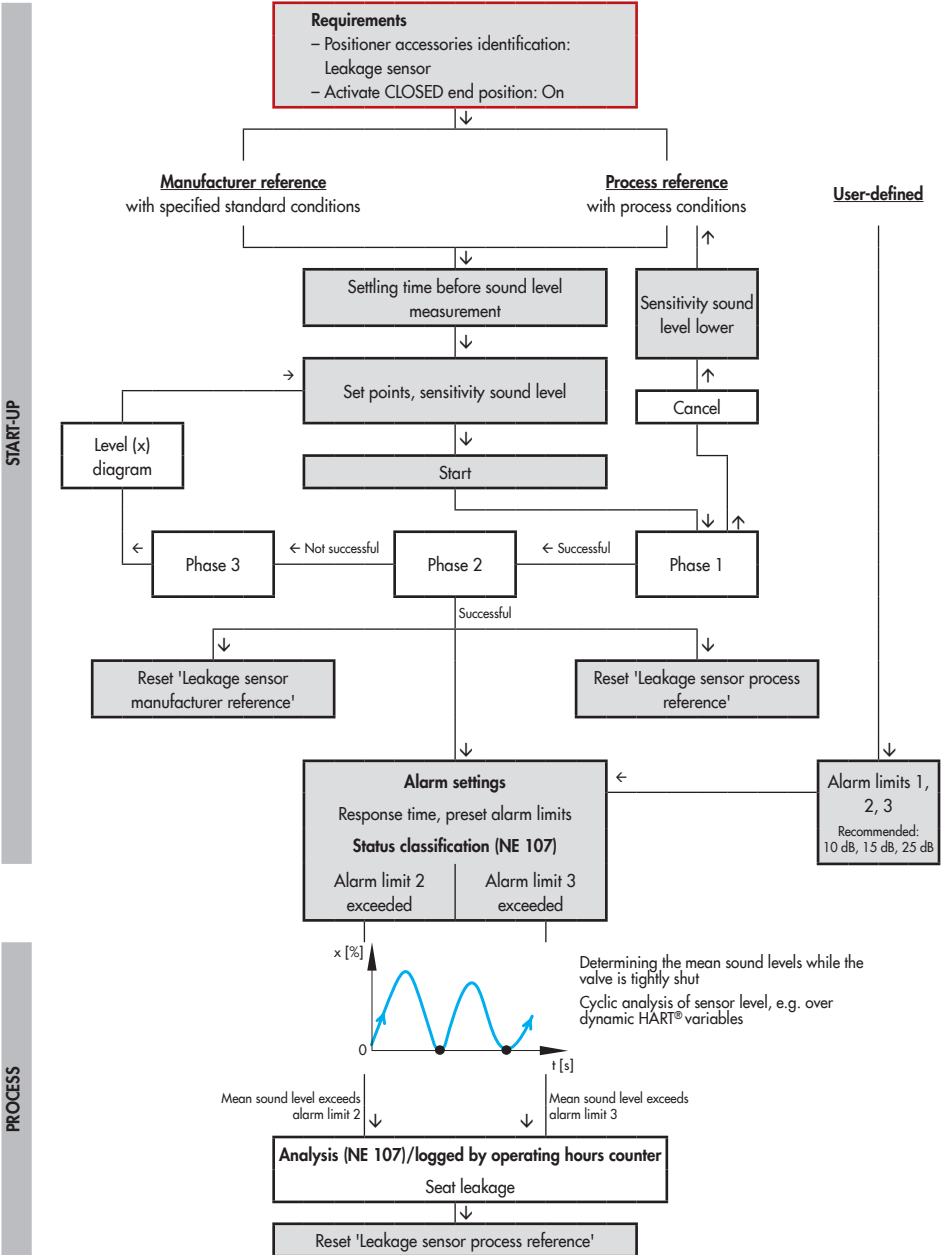

9 Leakage sensor

By upgrading the positioner with a leakage sensor, it is possible to detect seat leakage when the valve is in the closed position. To achieve this, the leakage sensor measures the sound pressure level (dB) while the valve is tightly shut and compares the current sound pressure level with predefined alarm limits. The positioner generates a message if the current sound pressure level exceeds one of the alarm limits.

Requirements for using the seat leakage sensor:

1. A leakage sensor is mounted to the valve. Refer to the standard mounting and operating instructions of the positioner ► EB 8384-6

2. The leakage sensor option has been selected.
3. The tight-closing function has been activated.
4. The leakage sensor has been put into operation. See ► Section 9.1.

Start-up > Reference graphs > Leakage sensor

2. – Positioner accessories identification:
Leakage sensor

Device settings > Positioner > Transfer characteristic or Transfer characteristic on/off

3. – Activate CLOSED end position (Code 14):
On
– CLOSED end position (Code 14):
0.0 to 49.9 %, [1.0 %]

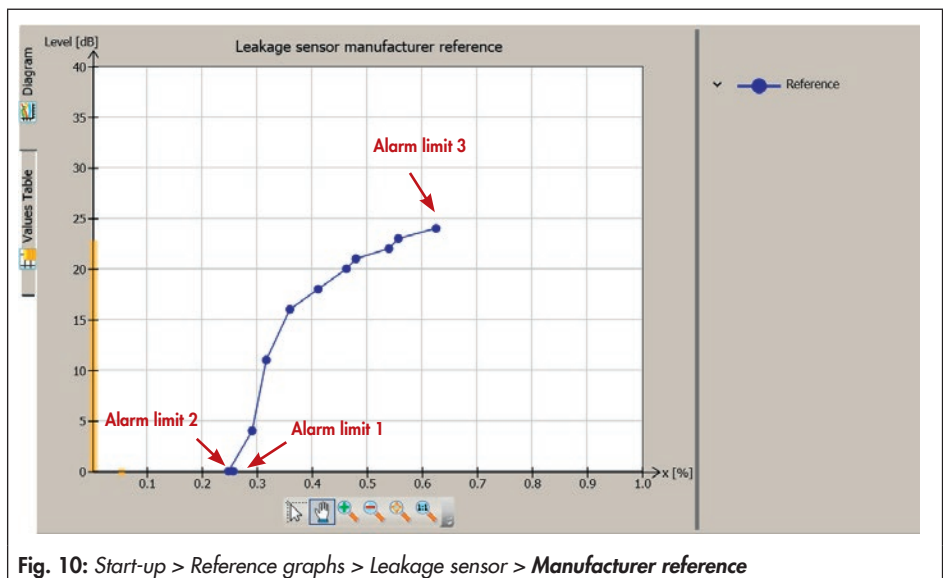

Fig. 10: Start-up > Reference graphs > Leakage sensor > **Manufacturer reference**

9.1 Start-up of the leakage sensor

To be able to use the full scope of functions, the response of the leakage sensor to standardized conditions and to the prevailing process conditions must be measured. Furthermore, the limit to activate the alarm must be entered.

9.1.1 Manufacturer reference

The manufacturer reference (► Fig. 10) measures the response of the leakage sensor. We recommend performing the manufacturer reference test. On request, it can also be performed by SAMSON and must not be performed again. In this case, the standard conditions are:

- Medium = air
- Input pressure = 4 bar
- Output pressure = atmosphere

Default values of alarm limits are $A2 = 15$ dB and $A3 = 25$ dB. **If the leakage sensor has been fitted later onto the valve, the alarm limits must be manually configured or adjusted by performing a manufacturer or process reference test before the leakage sensor can be used.** See ► Section 9.1.2.

While the manufacturer reference test is running, the parameters listed below are automatically deactivated:

- Activate CLOSED end position
- Activate ramp function

Phase 1: The valve moves to eleven defined set points one after the other. After reaching

a set point and after the 'Settling time before sound level measurement' has elapsed, the leakage sensor measures the sound pressure level.

If the difference between two neighboring set points is larger or equal to the adjusted 'Sensitivity sound level', the valve does not move to the next set points. Instead, Phase 2 starts.

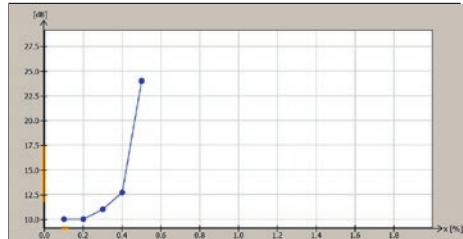

Phase 1 successful: The sound pressure level exceeded the adjusted 'Sensitivity sound level' (10 dB) between set points 4 and 5. Phase 2 starts.

If the 'Sensitivity sound level' is not reached after the valve has moved to all eleven set points, the test is canceled. The canceled test is logged with a time stamp. The 'Test information' reading indicates 'Test failed: sound level change too small'.

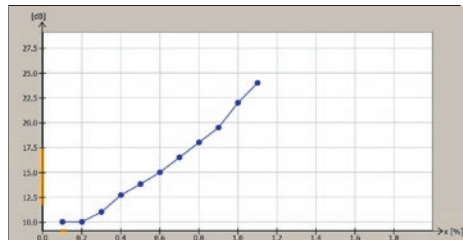

Phase 1 not successful: The difference in sound pressure level between two neighboring set points is smaller than the 'Sensitivity sound level' (10 dB). The reference test is canceled.

Phase 2: A 0.30 % band is placed around the last set point that the valve moved to. One third of this band lies in front of the set point that the valve moved to and two thirds of the band lies behind it. The band itself is subdivided into eleven fixed points. Each fixed point is located at a distance of 0.03 % to the next point. The valve moves to the new fixed points one after the other. After reaching a fixed point and after the 'Settling time before sound level measurement' has elapsed, the leakage sensor measures the sound pressure level.

The manufacturer reference test is successful when the difference between the first and last newly defined points is larger or equal to the adjusted 'Sensitivity sound level'.

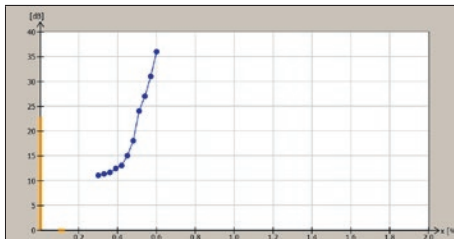

Phase 2 successful: The 'Sensitivity sound level' (10 dB) is reached between the first and last newly defined points. The manufacturer test is successfully completed.

If the 'Sensitivity sound level' is not reached after the valve has moved to all eleven newly defined points, then the change in sound pressure level is too low. In this case, phase 3 starts.

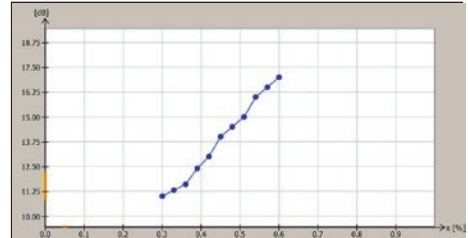

Phase 2 not successful: The difference in sound pressure level between the first and last newly defined points is lower than 'Sensitivity sound level' (10 dB). Phase 3 starts.

Phase 3: The valve moves to the set points valid for phase 1 one after the other. This is plotted in a sound level vs. travel graph. The graph shows where the point of activation is and to which value the 'Sensitivity sound level' must be reduced to allow the test to be completed successfully.

Defining parameters

Note:
The parameters can only be defined in TROVIS-VIEW 4 after the 'Positioner accessories identification' has been set to 'Leakage sensor'.

1. Switch to manual mode.
2. Define the parameters for the manufacturer reference test. Refer to *Note concerning editing set points*.
3. Start manufacturer reference test. The start of the reference test is documented in the Time stamp. 'DB' and 'TEST' are indicated in alternating sequence on the positioner display.

Leakage sensor

Start-up

1. – Enter operating mode (Code 0): **Manual**

Start-up > Reference graphs > Leakage sensor > Manufacturer reference

2. – Settling time before sound level measurement: 1 to 255 s, [5 s]
 - Sensitivity sound level: 3 to 255 dB, [10 dB]
 - Edit set points: 0.00 to 100.00 %
[1: 0.00 %; 2: 0.10 %; 3: 0.20 %;
4: 0.30 %; 5: 0.40 %; 6: 0.50 %; 7: 0.60 %;
8: 0.70 %; 9: 0.80 %; 10: 0.90 %,
11: 1.00 %]
3. – Start manufacturer reference

i Note

By selecting and executing 'Cancel manufacturer reference' or by pressing the rotary pushbutton, the manufacturer reference test is canceled (Test information = 'Test canceled manually'). After canceling the manufacturer reference test, the positioner remains in the manual mode.

In TROVIS-VIEW 4 the test information and progress flag of the manufacturer reference test are displayed. When the manufacturer reference test has been successfully completed, the Test information reading indicates 'Test completed successfully'.

Note concerning editing set points

- The entered set points must continuously increase from 'Set point 1' to 'Set point 11'.

- The valve moves to the set points in steps of 0.1 %. Set points must be rounded up to two decimal places.
- User-defined settings can be saved for other functions (e.g. process reference test) in a file.

9.1.1.1 Assessment

While the manufacturer reference test is running, the positioner determines three alarm limits. The relation between Valve position x [%] and Sound level [dB] is shown in TROVIS-VIEW 4:

- Relation 1: Valve position and sound level at 0 % position
- Relation 2: Valve position and sound level at the point where the curve in the 'Leakage sensor manufacturer reference' graph starts to rise monotonously
- Relation 3: Valve position and sound level at the last measurement

9.1.1.2 Resetting single status messages

The short-term monitoring (parameters, measured data and analysis) can be reset by selecting and executing the command "Reset 'leakage sensor manufacturer reference'".

If the test is restarted and a test analysis has already been performed, the analysis of the old manufacturer reference test is overwritten.

Diagnostics > Service/maintenance > Reset

- Reset 'Leakage sensor manufacturer reference'

9.1.2 Process reference

The process reference test (Fig. 11) measures the response of the leakage sensor to process conditions. Process medium, inlet and outlet pressures as well as the process environment can have an effect on the sensor's response. The alarm limits are determined from the measured data.

The process reference test is performed and analyzed in the same manner as the manufacturer reference test described in ► Section 9.1.1. This test must be performed after the valve has been installed and the plant has been commissioned.

If it is not possible to perform the process reference test, the user-defined alarm limits can be entered. See ► Section 9.1.2.2.

While the process reference test is running, the parameters listed below are automatically deactivated:

- Activate CLOSED end position
- Activate ramp function

Phase 1: The valve moves to eleven defined set points one after the other. After reaching a set point and after the 'Settling time before sound level measurement' has elapsed, the leakage sensor measures the sound pressure level.

If the difference between two neighboring set points is larger or equal to the adjusted 'Sensitivity sound level', the valve does not move to the next set points. Instead, Phase 2 starts.

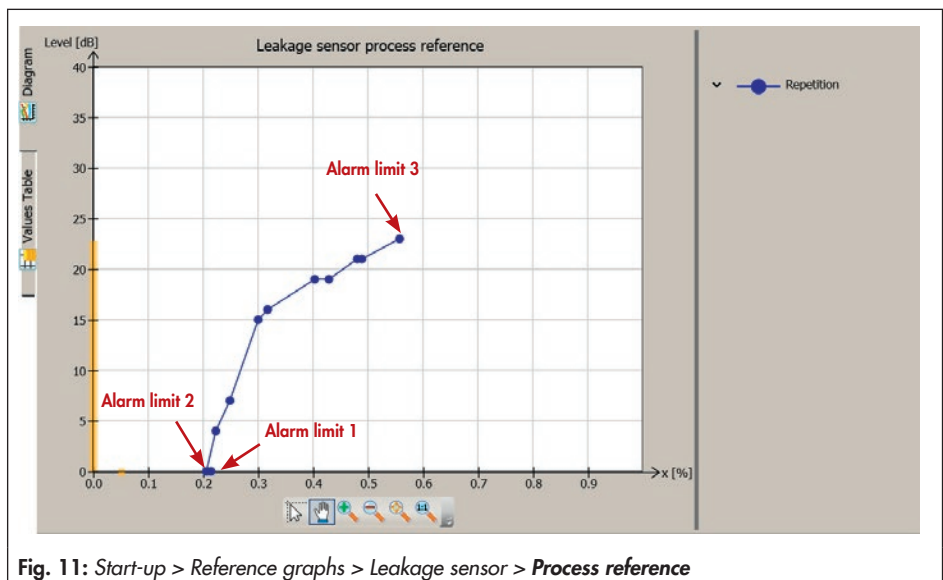
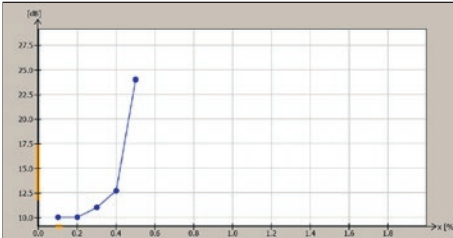

Fig. 11: Start-up > Reference graphs > Leakage sensor > Process reference

Leakage sensor



Phase 1 successful: The sound pressure level exceeded the adjusted 'Sensitivity sound level' (10 dB) between set points 4 and 5. Phase 2 starts.

If the 'Sensitivity sound level' is not reached after the valve has moved to all eleven set points, the test is canceled. The canceled test is logged with a time stamp and the 'Test information' reading indicates 'Test failed: sound level change too small'.

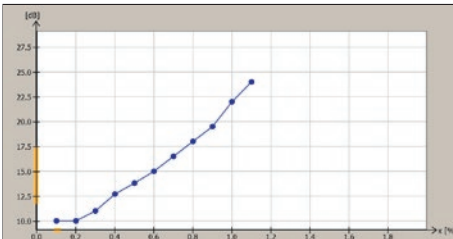

Phase 1 not successful: The difference in sound pressure level between two neighboring set points is smaller than the 'Sensitivity sound level' (10 dB). The process reference test is canceled.

Phase 2: A 0.30 % band is placed around the last set point that the valve moved to. One third of this band lies in front of the set point that the valve moved to and two thirds of the band lies behind it. The band itself is subdivided into eleven fixed points. Each fixed point is located at a distance of 0.03 % to the next point. The valve moves to the new

fixed points one after the other. After reaching a fixed point and after the 'Settling time before sound level measurement' has elapsed, the leakage sensor measures the sound pressure level.

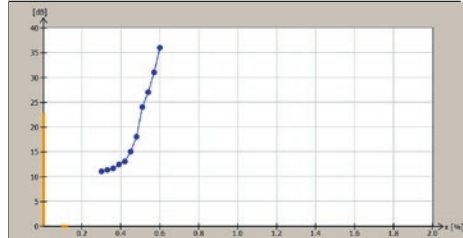

Phase 2 successful: The 'Sensitivity sound level' (10 dB) is reached between the first and last newly defined points. The process reference test is successfully completed.

The process reference test is successful when the difference between the first and last newly defined points is larger or equal to the adjusted 'Sensitivity sound level'.

If the 'Sensitivity sound level' is not reached after the valve has moved to all eleven newly defined points, then the change in sound pressure level is too low. In this case, phase 3 starts.

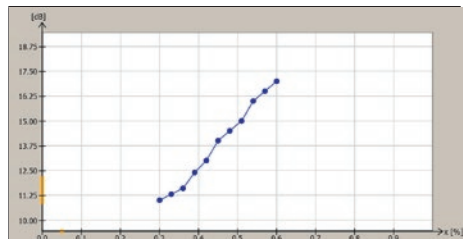

Phase 2 not successful: The difference in sound pressure level between the first and last newly defined points is lower than 'Sensitivity sound level' (10 dB). Phase 3 starts.

Phase 3: The valve moves to the set points valid for phase 1 one after the other. This is plotted in a sound level vs. travel graph. The graph shows where the point of activation is and to which value the 'Sensitivity sound level' must be reduced to allow the test to be completed successfully.

Defining parameters

i Note

The parameters can only be defined in TROVIS-VIEW 4 after the 'Positioner accessories identification' has been set to 'Leakage sensor'.

1. Switch to manual mode (Code 0 = MAN).
2. Define the parameters for the process reference test. Refer to *Note concerning editing set points*.
3. Start process reference test.
The start of the reference test is documented in the Time stamp.
'D9' and 'TEST' are indicated in alternating sequence on the positioner display.

Start-up

1. – Enter operating mode (Code 0): **Manual**

Start-up > Reference graphs > Leakage sensor > Process reference

2. – Settling time before sound level measurement: 1 to 255 s, [5 s]
– Sensitivity sound level: 3 to 255 dB, [10 dB]
– Edit set points: 0.00 to 100.00 %
[1: 0.00 %; 2: 0.10 %; 3: 0.20 %; 4: 0.03 %; 5: 0.04 %; 6: 0.05 %; 7: 0.06 %; 8: 0.07 %; 9: 0.08 %; 10: 0.09 %, 11: 1.00 %]

3. – Start process reference

i Note

By selecting and executing 'Cancel reference reference' or by pressing the rotary pushbutton, the process reference test is canceled (Test information = 'Test canceled manually'). After the test has been canceled, the positioner remains in manual mode.

In TROVIS-VIEW 4 the test information and progress flag of the test are displayed. When the process reference test has been successfully completed, the Test information reading indicates 'Test completed successfully'.

Note concerning editing set points

- The entered set points must continuously increase from 'Set point 1' to 'Set point 11'.
- The valve moves to the set points in steps of 0.1 %. Set points must be rounded up to two decimal places.
- User-defined settings can be saved for other functions (e.g. another process reference test) in a file.

9.1.2.1 Assessment

While the process reference test is running, the positioner determines three alarm limits. The relation between Valve position x [%] and Sound level [dB] is shown in TROVIS-VIEW 4:

- Relation 1: Valve position and sound level at 0 % position

Leakage sensor

- Relation 2: Valve position and sound level at the point where the curve in the 'Leakage detection process reference' graph starts to rise monotonously
- Relation 3: Valve position and sound level at the last measurement

9.1.2.2 Alarm settings

After connecting the leakage sensor and performing the manufacturer and process reference tests, the positioner is able to pinpoint any seat leakage. To do this, it records the sound level in closed-loop operation while the valve is tightly shut. The seat leakage monitoring is performed automatically while the process is running.

The alarm limits detected in the manufacturer reference test, process reference test or user-defined settings can be selected. When user-defined limits are entered, the alarm limits

must rise continuously from 'Alarm limit 1' to 'Alarm limit 3'.

During closed-loop operation, the mean sound levels while the valve is tightly shut are compared to the alarm limits. Which mean sound level is to be used for comparison can be selected in 'Response time':

- **Very quick:** The mean value calculated from the current sound level and from the last four sound levels measured while the valve is tightly shut is used for monitoring (Fig. 12: Tight-closing event 31 and sound level E to I).
- **Quick:** The mean value calculated from all sound levels measured while the valve is tightly shut is used for monitoring (Fig. 12: Tight-closing event 31 and sound level A to I).

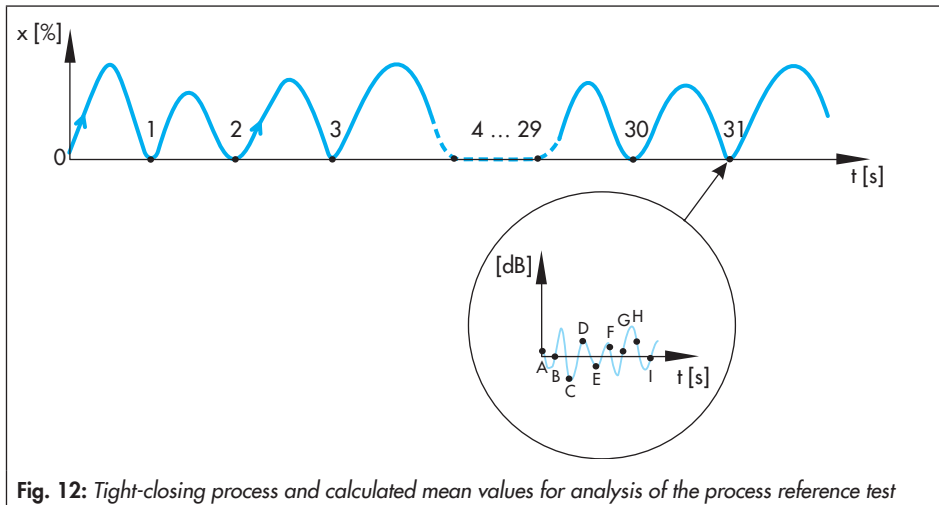

Fig. 12: Tight-closing process and calculated mean values for analysis of the process reference test

- **Slow:** The mean value calculated from the last 30 sound levels measured during short-term monitoring (see ► Section 9.2) is used for monitoring (Fig. 12: Tight-closing event 2 to Tight-closing event 31 with all sound levels).
- **Very slow:** The mean value calculated from all the sound levels measured during long-term monitoring (see ► Section 9.3) is used for monitoring (Fig. 12: Tight-closing event 1 to Tight-closing event 31 with all sound levels).

The 'No alarm triggering' setting deactivates the alarm function.









Defining parameters

1. Define alarm parameters.
2. Select classification for status messages. See ► Section 9.1.2.3.

Start-up > Reference graphs > Leakage sensor > Process reference

1. – Response time: [No alarm triggering], Very quick, Quick, Slow, Very slow
– Preset alarm limits ¹⁾: [Manufacturer reference], Process reference, User-defined

Device settings > Alarm settings > Status classification > Valve

2. – Alarm limit 2 exceeded:
[, , , ]
– Alarm limit 3 exceeded:
[, , , ]





¹⁾ On selecting the alarm limit 'User-defined', we recommend checking the correct setting of the alarm limits using an operating time of one to three months based on the measured data in 'Sound level monitoring' diagram (see ► Section 9.4).

9.1.2.3 Monitoring

If the determined mean sound level exceeds the 'Alarm limit 2', the positioner generates a 'Seat leakage' message with status classification selected for 'Alarm limit 2 exceeded'.

If the determined mean sound level exceeds the 'Alarm limit 3', the positioner generates a 'Seat leakage' message with status classification selected for 'Alarm limit 3 exceeded'.

Diagnostics > Monitoring > Valve

– Seat leakage: , , , 

9.1.2.4 Reset

The process reference test (diagnostic parameters, measured data and analysis) and the 'Seat leakage' message can be reset by selecting and executing the command "Reset 'leakage sensor process reference'".

If the test is restarted and a test analysis has already been performed, the analysis of the old process reference test is overwritten.

Diagnostics > Service/maintenance > Reset

– Reset 'Leakage sensor process reference'

9.2 Short-term monitoring

Short-term monitoring provides an insight into short-term changes in the sound level while the valve is tightly shut.

Data are recorded in the background regardless of the operating mode selected. Data logging does not need to be activated.

The leakage sensor records the sound level when the valve leaves the tightly shut position or whenever the sound level changes by 2 dB. A mean value is calculated from the recorded sound level and last four recorded sound levels.

If this value deviates from the previous mean value by 'Sensitivity sound level', the new

mean value is saved in the short-term monitoring.

The last 'Mean value' recorded in the short-term monitoring is indicated.

The positioner saves the mean values of the sound level and valve travel in a circular buffer, which holds 30 measured values at one time together with a time stamp. The saved values can be read in the **Measured data assessment** folder.

Defining parameters

1. Enter the sensitivity sound level.

Diagnostics > Monitoring/tests > Leakage sensor > Short-term monitoring

1. – Sensitivity sound level: 3 to 255 dB, [3 dB]

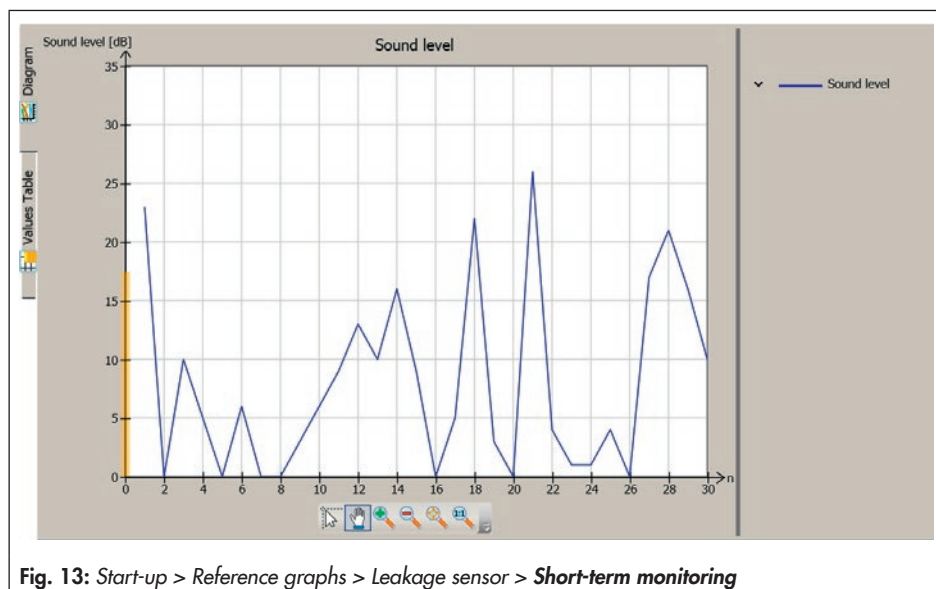

Fig. 13: Start-up > Reference graphs > Leakage sensor > Short-term monitoring

9.2.3 Resetting single status messages

The short-term monitoring (diagnostic parameters, measured data and analysis) can be reset by selecting and executing the command "Reset 'Short-term leakage sensor monitoring'". The data in the Measured data assessment folder are reset as well.

Diagnostics > Service/maintenance > Reset

– Reset 'Short-term leakage sensor monitoring'

9.3 Long-term monitoring

To obtain a sound level trend over a long period of time, the long-term monitoring contains all the mean values saved in the short-term monitoring since the last reset:

- 'Mean value': The average sound level calculated from 'No. of measuring points'
- 'No. of measuring points'

Data are recorded in the background regardless of the operating mode selected. Data logging does not need to be activated.

9.3.1 Resetting single status messages

The measured data of the long-term monitoring are reset by selecting and executing the command "Reset 'Leakage detection - Long-term monitoring'".

Diagnostics > Service/maintenance > Reset

– Reset 'Leakage sensor - Long-term monitoring'

9.4 Sound level(x)

The sound level monitoring is shown in a histogram. The distribution of recorded sound levels within fixed classes of valve position x is revealed.

The leakage sensor records the sound level every second and assigns the data into pre-defined valve positions classes. The distribution showing how often the sound level occurred within a valve position class is shown in a bar graph.

Data are recorded in the background regardless of the operating mode selected. Data logging does not need to be activated.

9.4.2 Resetting single status messages

The measured data of the sound level monitoring are reset by selecting and executing the command "Reset 'Leakage sensor sound level(x)".

Diagnostics > Service/maintenance > Reset

– Reset 'Leakage sensor sound level(x)'

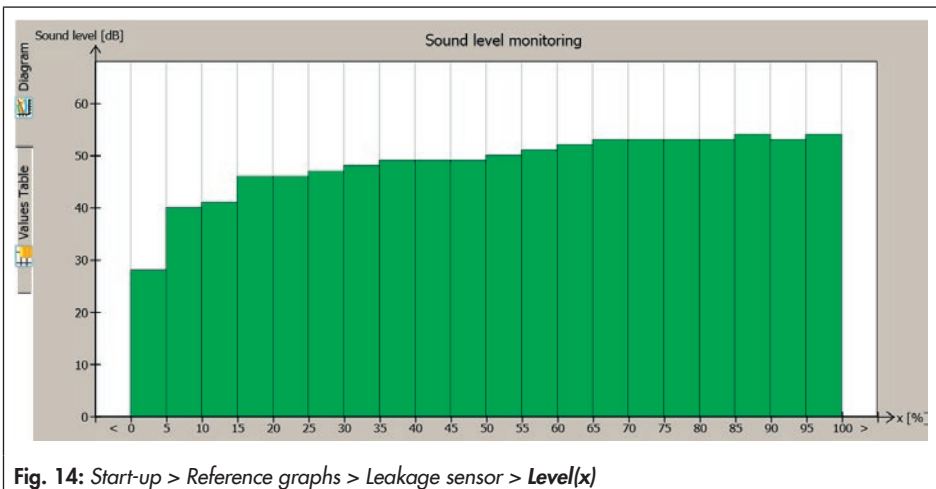

Fig. 14: Start-up > Reference graphs > Leakage sensor > Level(x)

Course of end position

START-UP

Prerequisite
 – Activate CLOSED end position: On

Recording threshold

Alarm settings (NE 107)
 Course of end position

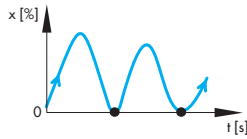

Valve signature complete?
 ▶ Section 4.1

PROCESS

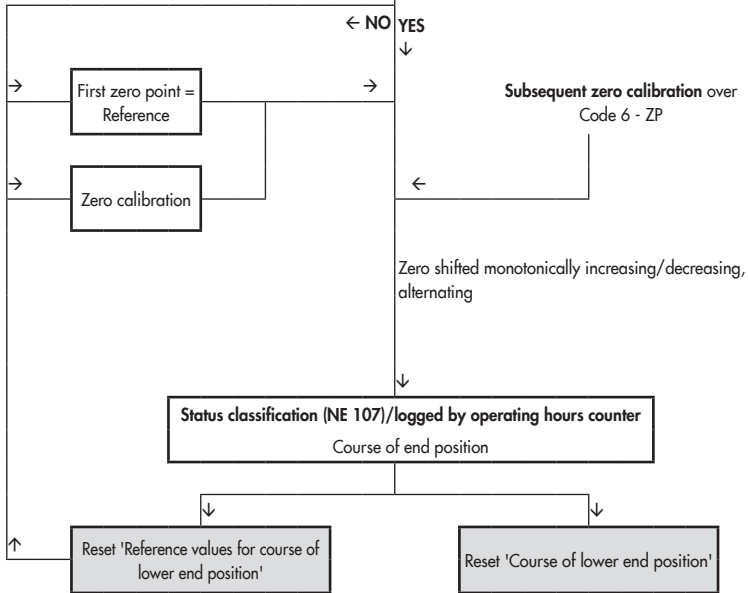

10 Course of end position

The course of end position is used to detect an alternating zero point or a creeping zero point shift due to seat and plug wear or dirt between the seat and plug.

Data are recorded in the background regardless of the operating mode selected if the tight-closing function (Code 14) is active. Data logging does not need to be activated.

The course of the end position records the valve position x and the signal pressure p_{out} together with the time stamp by the operating hours counter when the valve moves to the lower end position. The new recorded valve position is compared to the last saved zero point. If it differs by the 'Recording

threshold' from the last value, the data of the new zero point are saved.

A graph of the recorded valve positions at the lower end position is plotted over time.

The positioner saves the valve positions in a circular buffer, which holds 30 measured values at one time. The recorded measured data are listed in the **Lower end position** folder.

Defining parameters

1. Activate tight-closing function.
2. Define 'Recording threshold'.
3. Select classification for status messages.

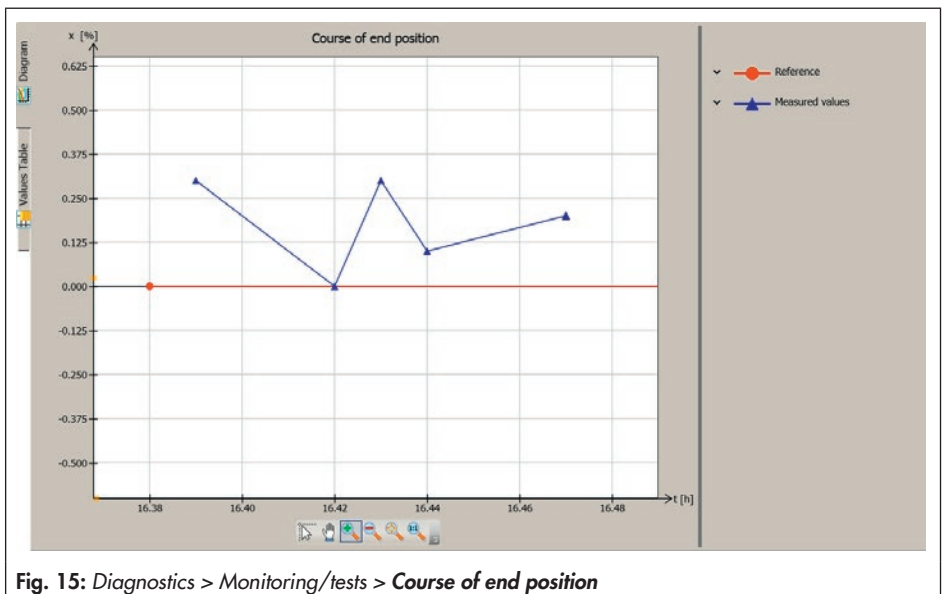

Fig. 15: Diagnostics > Monitoring/tests > Course of end position









Device settings > Positioner > Transfer characteristic or Transfer characteristic on/off

1. – Activate CLOSED end position (Code 14):
On
– CLOSED end position (Code 14):
0.0 to 49.9 %, [1.0 %]

Device settings > Alarm settings

2. – Recording threshold:
0.10 to 5.00 %, [0.25 %]

Device settings > Alarm settings > Status classification > Valve position

3. Course of end position
 - Monotonically increasing: [⊗], , , 
 - Monotonically decreasing: [⊗], , , 
 - Alternating: [⊗], , , 

10.1 Analysis and monitoring



A reference zero point must be recorded to analyze the course of the end position. This is recorded during the valve signature reference test (see ► Section 4.1). In case a reference test has not been performed, the first zero point that the valve moved to serves as the reference value. The reference value is represented by a straight line in the course of end position graph.

Note

If the reference value has been reset by selecting and executing "Reset 'Reference values for course of lower end position'" (see ► Section 2.1.1), the first zero point that the valve moves to after the reset serves as the new reference value, provided it does not exceed the 'Zero limit' (Code 48 - d5).

If the analysis of course of the end position pinpoints to a fault, the positioner generates the 'Course of end position' message with the selected status classification.

Diagnostics > Monitoring > Valve position

- Course of end position: , , , 

10.2 Resetting single status messages

The 'Course of end position' message and the measured data for the course of the end position can be reset by selecting and executing "Reset 'Course of lower end position'".

If only the reference zero point is to be reset, select and execute "Reset 'Reference values for course of lower end position'".

Diagnostics > Service/maintenance > Reset

- Reset 'Course of lower end position'
- Reset 'Reference values for course of lower end position'

11 Valve dead band

The difference in set point w that causes a minimal change in the valve position x is termed 'dead band'.

The valve dead band is affected by the friction hysteresis and the elastic processes in the valve stem packing.

The test is started in the manual mode.

The positioner specifies the set point w in a defined test range ('Lower range value' and 'Stop') in small steps and records the response of the valve position x after waiting a 'Waiting time after step change'. The step height is determined automatically from the number of measured values ('No. until reversing') and the defined test range. The ascending and descending are plotted within

the test range. The response of the valve position x to the change in set point (Δw) is plotted in a graph.

The dead band is analyzed in the positioner when a step height is smaller than 0.2 %.

- 'Mean dead band': Average change in set point that causes a minimal change in the valve position.
- 'Min. dead band': Minimum change in set point that causes a minimal change in the valve position.
- 'Max. dead band': Maximum change in set point that causes a minimal change in the valve position.

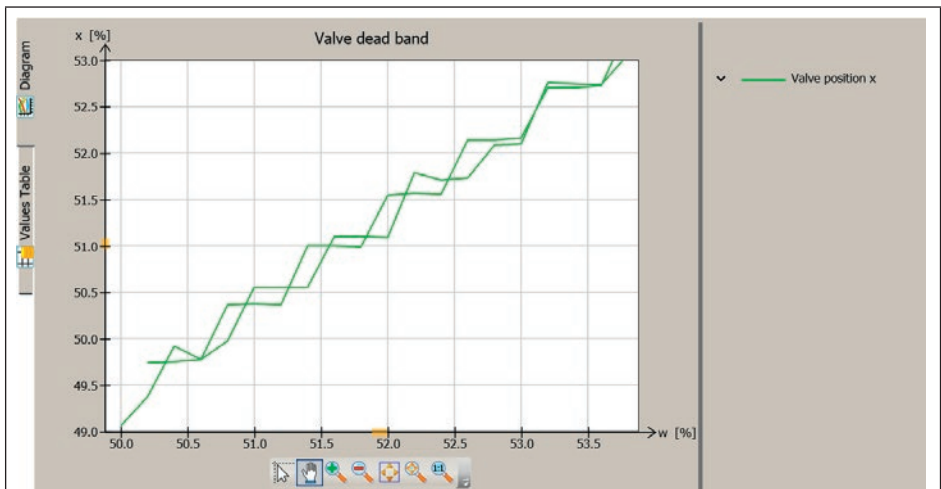



Fig. 16: Diagnostics > Monitoring/tests > Dynamic tests > Valve dead band

Defining parameters

1. Switch to manual mode (Code 0 = MAN).
2. Select test parameters.
3. Start test.

The 'Test information' status indicates 'Test active'. 'D3' and 'TEST' are indicated in alternating sequence on the positioner display.

'Function check'  is activated as the condensed state.

Diagnostics > Service/maintenance > Operating mode

1. – Enter operating mode (Code 0): Manual

Diagnostics > Monitoring/tests > Dynamic tests > Valve dead band

2. – Lower range value: 0.0 to 100.0 %, [50.0 %]
– Stop: 0.0 to 100.0 % [52.0 %]
– Waiting time after step change: 0.1 to 25.0 s, [1.0 s]
– No. until reversing: 1 to [50]

3. – Start test

Note

Cancel the test by right-clicking 'Cancel test' and selecting 'Execute' or by pressing the rotary pushbutton at the positioner. After the test has been canceled, the positioner remains in manual mode.

In TROVIS-VIEW 4 the test information and progress flag of the test are displayed. The 'Test information' status indicates 'Test not active' after the test is finished.

11.1 Resetting single status messages

The diagnostic parameters and measured data of the last test are reset by selecting and executing the command "Reset 'Valve dead band".

If the test is restarted and a test analysis has already been performed, the analysis of the old test is overwritten.

Diagnostics > Service/maintenance > Reset

- Reset 'Valve dead band'

Partial stroke test (PST)

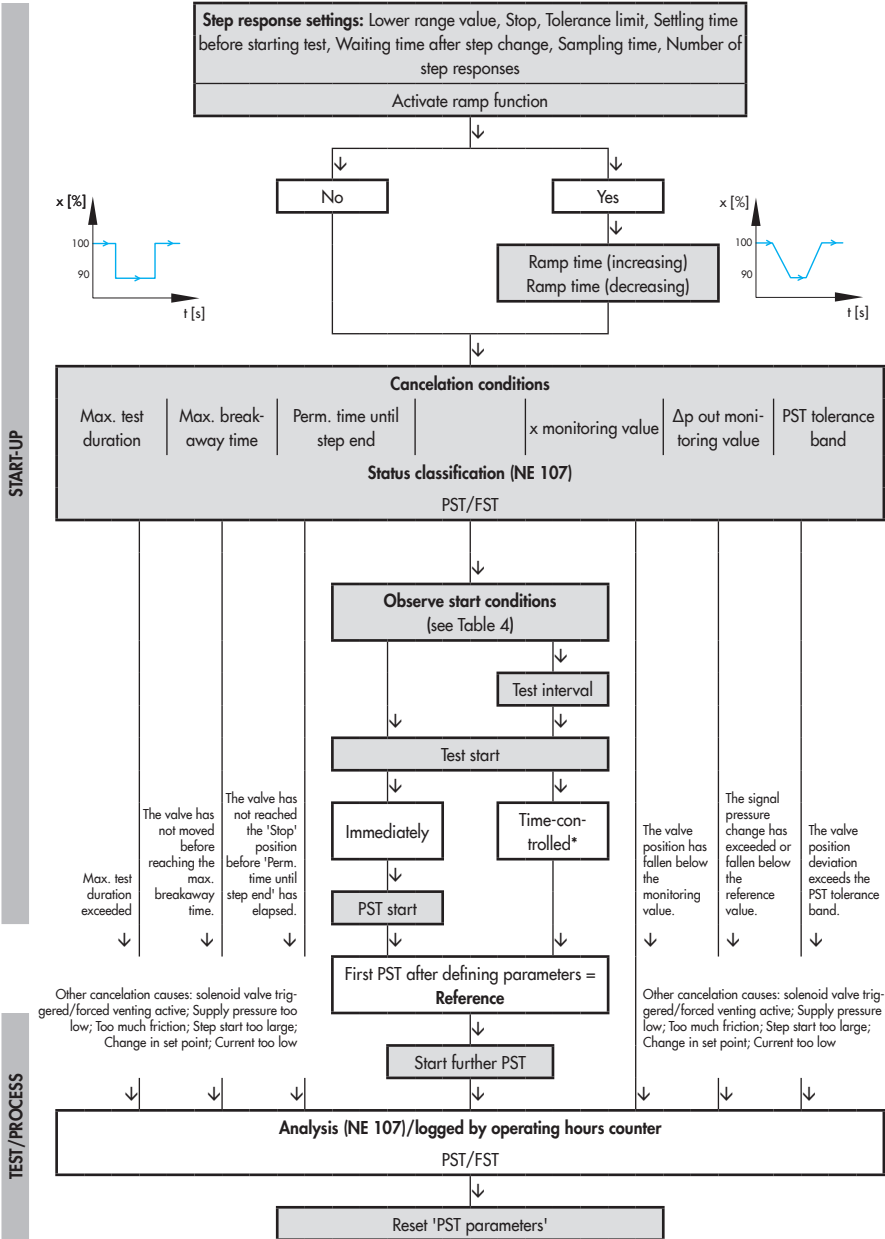

* Note! The positioner is write-protected when tests are performed according to a schedule (local operation and operating software).

12 Partial stroke test (PST)

The partial stroke test (PST) is particularly suitable for the status-oriented detection of malfunctions in pneumatic shut-off valves. As a result, the probability of failure on demand (PFD) can be reduced and it may be possible to extend maintenance intervals.

A shut-off valve normally in its end position can be prevented from seizing up or getting jammed. The breakaway torque must be overcome when the plug starts to move out of its open position. This breakaway torque depends on the seal, deposits on the seat and plug, the process medium and friction in the valve trim. After the breakaway torque has been overcome, it can be assumed that the valve is able to completely close. Recording the test results additionally allows an analysis of the dynamic control response.

The partial stroke test can be performed once (test immediately started) or, with an on/off valve in automatic mode, regularly (time-controlled), provided the start conditions are met (see ► Table 4):

- A control valve is in the manual mode.
- An on/off valve is in the manual or automatic mode. In automatic mode, the test is only started when the Set point w is greater than the 'Fail-safe action limit' (Code 49 - h2).

The following listed parameters are activated while the partial stroke test is being performed:

- Characteristic selection (Code 20): Linear
- Required transit time OPEN (Code 21): Variable
- Required transit time CLOSED (Code 22): Variable

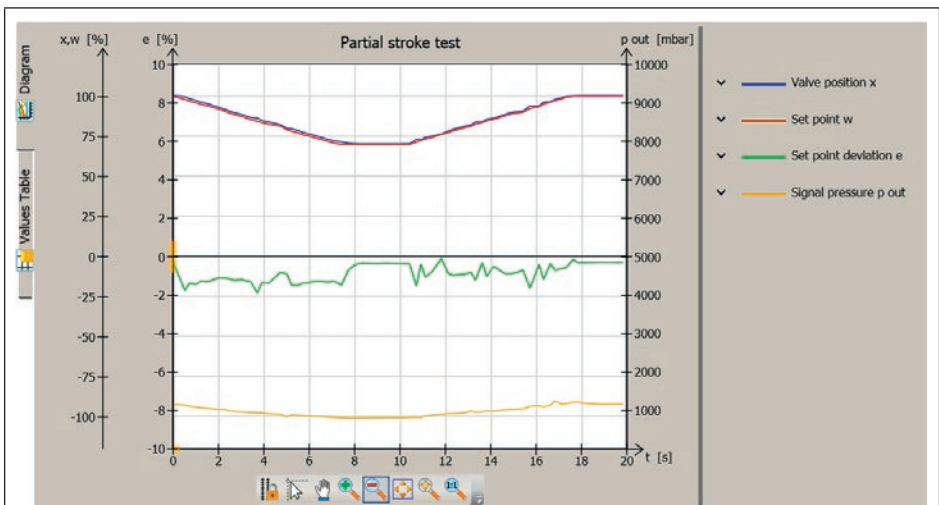

Fig. 17: Diagnostics > Monitoring/tests > Dynamic tests > Partial stroke test (PST)

Partial stroke test (PST)

During the partial stroke test, the valve moves from its current operating point to a defined 'Stop' value and back to the initial position again.

The change in travel can be performed either in steps or in a ramp function (Fig. 18). For the test in a ramp function, additionally the ramp times for the increasing and decreasing ramps need to be defined.

To perform a partial stroke test, the 'Lower range value' must be near the current operating point \pm 'Tolerance limit'.

After being activated, the test does not start until the 'Settling time before starting test' has elapsed. Based on the operating point, the valve moves until reaching the 'Stop'

valve position. The valve remains in this position for the time defined by the 'Waiting time after step change' before performing a second step change in the opposite direction from 'Stop' to the operating position. The 'Sampling time' defines the time interval between which the measured values are recorded during the test.

Test cancellation conditions

Various cancellation conditions provide additional protection against the valve slamming shut or moving past the end position. The positioner cancels the partial stroke test when one of the following cancellation conditions is fulfilled:

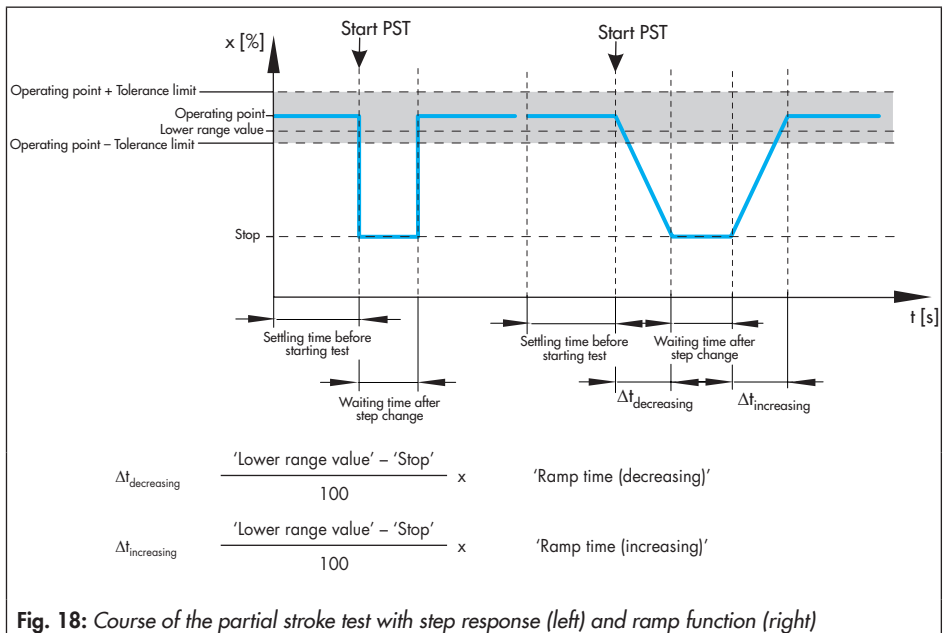

Cancelation conditions, time-out

- 'Max. test duration': The test is canceled when the maximum permissible test duration is reached.
- 'Max. breakaway time': The test is canceled when the valve position has reached less than 10 % of the PST target travel after the defined time has elapsed. This cancelation condition only becomes effective after it has been activated ("Activate 'Max. breakaway time'" = [Yes]).
- 'Perm. time until step end': The test is canceled when the time entered in 'Settling time before starting test' has elapsed before the valve has reached its 'Stop' position. This cancelation condition only becomes effective after it has been activated ("Activate 'Perm. time until step end'" = [Yes]).

Cancelation condition - valve position x (to check the valve position)

- 'x monitoring value': The test is canceled as soon as the valve position falls below the adjusted value. This cancelation condition only becomes effective after it has been activated ('Activate x monitoring' = Yes).

Cancelation condition, signal pressure Δp out

- ' Δp out monitoring value': The test is canceled if the change in signal pressure exceeds or falls below the reference value. The reference value is made up of ' Δp out reference value' and ' Δp out monitoring value'. This cancelation condition

only becomes effective after it has been activated ('Activate Δp out monitoring' = Yes).

The positioner determines the ' Δp out reference value' from both signal pressures issued at the start and end of the step. It only applies to adjusted step change and ramp values.

Cancelation condition, tolerance band

- 'PST tolerance band': The test is canceled as soon as the deviation of the valve position (in relation to the step end value (Stop)) exceeds the adjusted PST tolerance band. This cancelation condition only becomes effective after it has been activated ('Activate PST tolerance band monitoring' = Yes).

i Note

- *The partial stroke test must be performed with deactivated cancelation conditions for valves with double-acting actuator and pneumatic booster as well as for valves that have been initialized using the SUB mode (substitute calibration).*
 - *Excessive overshooting may occur in valves fitted with boosters. In this case, the cancelation conditions 'x monitoring value' and 'PST tolerance band' must be increased accordingly.*
-

Additionally, the partial stroke test is canceled when one of the following events arises:

- Cancel internal solenoid valve/forced venting: The test was canceled by the ac-

Partial stroke test (PST)

tivation of the solenoid valve/forced venting function.

- Canceled by control loop error: A control loop error has occurred.
- Set point start difference too high: During the step change, 'Lower range value' is outside the range (operating point \pm 'Tolerance limit').
- Set point change: Time-controlled start of the test. Due to a set point change before the step change, 'Lower range value' is outside the range (operating point + 'Tolerance limit').
- Current too low
- Supply pressure too low
- Electric current change: The partial stroke test of a control valve is canceled when the change in electric current \geq 'Tolerance band' (Code 19) arises.

The partial stroke test of an on/off valve is canceled when the valve moves from the operating position to the fail-safe position or from the fail-safe position to the operating position due to a change in electric current.

i Note

The 'Measured data storage out of memory' reading (Failure) is generated when the 'Sampling time' is too low. After recording 100 measured values per variable, logging is stopped, but the test continues until it is completed.

After the partial stroke test is canceled, the 'PST status' reading indicates 'Not success-

ful'. The reason for cancelation is marked by the 'Failure' message in the **Measured data assessment** folder (> Current test).

Defining parameters

1. Define parameters for the partial stroke test. See also ► *Note concerning setting the PST diagnostic parameters*. (The default settings partly depend on the closing position ATO/ATC.)
2. Define parameters for cancelation conditions.
3. Select classification for status messages.
4. Start the partial stroke test.
The 'Test information' status indicates 'Test active'. 'D4' and 'TEST' are indicated in alternating sequence on the positioner display. 'Function check' ▼ is activated as the condensed state.

1. Diagnostics > Monitoring/tests > Dynamic tests > Partial stroke test (PST)

- Lower range value (Code 49 - d2): 0.0 to 100.0 %, [ATO: 100.0 %; ATC: 0.0 %]
- Stop (Code 49 - d3): 0.0 to 100.0 % [ATO: 90.0 %; ATC: 10 %]
- Tolerance limit: 0.1 to 10.0 %, [2.0 %]
- Activate ramp function (Code 49 - d4): [Yes], No
- Settling time before starting test (Code 49 - d7): 1 to 240 s, [2 s]
- Waiting time after step change (Code 49 - d8): 1.0 to 240.0 s, [2.0 s]
- Sampling time (Code 49 - d9): 0.2 to 250.0 s, [0.8 s]

Only when the ramp function is activated:

- Ramp time (decreasing) (Code 49 - d5):
0 to 9999 s, [600 s]
- Ramp time (increasing) (Code 49 - d6):
0 to 9999 s, [60 s]

2. - Max. test duration (Code 49 - E7):
30 to 25000 s, [90 s]
 - Activate 'Max. breakaway time' [Yes], No
 - Max. breakaway time: 0.0 to 25000 s,
[30.0 s]
 - Activate 'Perm. time until step end' [Yes], No
 - Perm. time until step end:
0.0 to 25000 s, [70.0 s]
 - Activate x monitoring (Code 49 - E0): [Yes],
No
 - x monitoring value (Code 49 - E1):
-10.0 to 110.0 %, [ATO: 0.0 %; ATC: 85 %]
 - Activate Δp out monitoring (Code 49 - A8):
[Yes], No
 - Δp out monitoring value (Code 49 - A9):
0.00 to 7.00 bar, [1.00 bar]
 - Activate PST tolerance band monitor-
ing (Code 49 - E5): Yes, [No]
 - PST tolerance band (Code 49 - E6):
0.1 to 100.0 %, [5.0 %]

Device settings > Alarm settings > Status classification > PST/FST

3. - x cancelation: [⊗], [⚡], [⊗], [⚠]
 - Δp out cancelation: [⊗], [⚡], [⊗], [⚠]
 - Tolerance band exceeded: [⊗], [⚡], [⊗], [⚠]
 - Max. test duration exceeded:
[⊗], [⚡], [⊗], [⚠]
 - Test canceled manually: [⊗], [⚡], [⊗], [⚠]
 - Measured data memory full:
[⊗], [⚡], [⊗], [⚠]

- Cancel internal solenoid valve/forced venting: [⊗], [⚡], [⊗], [⚠]
- Canceled by control loop error:
[⊗], [⚡], [⊗], [⚠]
- Set point start difference too high:
[⊗], [⚡], [⊗], [⚠]
- Set point change: [⊗], [⚡], [⊗], [⚠]
- Current too low: [⊗], [⚡], [⊗], [⚠]
- Max. breakaway time exceeded:
[⊗], [⚡], [⊗], [⚠]
- Perm. time until step end exceeded:
[⊗], [⚡], [⊗], [⚠]
- Canceled by supply pressure:
[⊗], [⚡], [⊗], [⚠]

Diagnostics > Monitoring/tests > Dynamic tests > Partial stroke test (PST)

4. **Either:**

- Enter test start (Code 49 - A2) = **[Immediately]**

- Start test

Or:

(only when 'Type of application' = On/off valve)

- Enter test interval (Code 49 - A3):
[1 h] to 2345 d

- Enter test start (Code 49 - A2) = **Time-controlled**

NOTICE! The positioner is write-protected when tests are performed according to a schedule (local operation and operating software).

Code 0 reading: "O/C" and "PST" in alternating sequence

Code 3 reading: "PST" blinks.

i Note

Cancel the test by right-clicking 'Cancel test' and selecting 'Execute' or by pressing the rotary pushbutton at the positioner. After the test has been canceled, the positioner remains in selected mode. The 'PST status' reading indicates 'Not successful'.

In TROVIS-VIEW 4 the test information and progress flag of the test are displayed. The 'Test information' status indicates 'Test not active' after the test is finished.

Note concerning setting the PST diagnostic parameters

- We recommend only to start the partial stroke test when the valve is in the end position. In on/off valves, the start value must be the same as the operating point.
- The 'Ramp time (increasing)' must be greater than the corresponding value for 'Min. transit time CLOSED' (Code 41) determined during initialization.
- The 'Ramp time (decreasing)' must be greater than the corresponding value for 'Min. transit time OPEN' (Code 40) determined during initialization.
- The 'Sampling time' must not be lower than the indicated 'Recommended min. sampling time'. The 'Recommended min. sampling time' is calculated from the 'Expected duration of test'.

12.1 Start triggered by the set point

The partial stroke test of on/off valves is triggered when the set point w moves in the range between 25 and 50 % of the travel and remains there for longer than six seconds. See ► Section 5 and chart ► page 72.

The PST diagnostic parameter 'Lower range value' must be within the defined position \pm 'Tolerance limit' for the partial stroke test to start.

The test and its cancelation are described in section 12, while the test assessment is described in ► Section 12.3.

12.2 Start triggered by the binary input

If the positioner is fitted with the optional binary input, the partial stroke test can be started by the binary input when the conditions to start the partial stroke test are met:

- A control valve is in the manual mode.
- An on/off valve is in the manual or automatic mode. In automatic mode, the test is only started when the 'Safety set point' is greater than the 'Fail-safe action limit' (Code 49 - h2).

The test and its cancelation are described in section 12, while the test assessment is described in ► Section 12.3.

It is important to make sure that the diagnostic parameter 'Lower range value' of the

partial stroke test is within the range of the 'Safety set point' \pm 'Tolerance limit'.

Defining parameters





1. Select 'Binary input' in 'Positioner accessories identification'.
2. Configure the binary input.
3. Select classification for status message.

Device settings > Positioner > Options

1. – Positioner accessories identification: **Binary input**

Device settings > Positioner > Options > Configuration, binary input

2. – Binary input configuration: [For floating contact (switch function)], For non-floating contact (0-24 V)
 - Select function: **Start PST**
 - Binary input control: Activate function: switch open, [Activate function: switch closed]
 - Safety set point: 0.0 to 100.0 %, [50.0 %]

3. – Binary input classification:
 - [, , , 

i Note

Further details on optional binary input ► Section 15.

12.3 Analysis and monitoring

The analysis of the last three partial stroke tests are saved with a time stamp in the **PST measured data assessment** folder. A graph of the last partial stroke test is shown in the **Partial stroke test (PST)** folder.

Test completed successfully

When a partial stroke test has been completed successfully, the analyzed parameters are displayed separately for the increasing and decreasing characteristics.

Analysis of measured data (step response test):

- 'Overshooting' (relative to the step height) [%]
- 'Dead time' [s]
- 'T86' [s]
- 'Settling time' [s]

Analysis of measured data (ramp test):

- 'Overshooting' (relative to the step height) [%]

The results of the first partial stroke test are used as the reference measurement.

i Note

Changes in the diagnostic parameters listed below affect the test. The results of the next following partial stroke test is used as the new reference measurement:

- 'Lower range value'
- 'Stop'
- 'Activate ramp function'
- 'Ramp time (increasing)'
- 'Ramp time (decreasing)'
- 'Waiting time after step change'
- Test not completed

If the test was not completed, the reason for cancelation is indicated in the corresponding reading by the 'Failure' message. The posi-

Partial stroke test (PST)

tioner generates a 'PST/FST' message with the selected status classification.

Diagnostics > Monitoring

– PST/FST status (Code 84):    

i Note

The 'No test available' status remains active until a partial stroke is completed successfully.

12.4 Resetting single status messages

The diagnostic parameters and measured data analysis of the partial stroke test are reset by selecting and executing the command "Reset 'PST parameters'".

The positioner saves the measured data analysis of the last three partial stroke tests. The analysis of the penultimate test is deleted when another test is performed.

Diagnostics > Service/maintenance > Reset

– Reset 'PST parameters'

Table 4: Start options for the partial stroke test (PST)

Type of application	PST start by	Rotary pushbutton or operating software	Test interval (time-controlled)	Set point w	Binary input
	Operating mode	See page 73 Manual	See page 73 Automatic	See section 12.1 Automatic	See section 12.2 Automatic
Control valve	Automatic mode AUTO	Not possible	Not possible	–	Not possible
	Manual mode MAN	Possible	Not possible	–	Possible
On/off valve	Automatic mode AUTO	Possible	Possible	Possible	Possible
	Manual mode MAN	Possible	Possible	Not possible	Possible
Triggering event		Code 49 - A0 = YES or 'Start test' parameter activated	'Test interval' elapsed	Set point is six seconds long in the range between 25 and 50 % of travel	Binary input changes to 'Switch open' or 'Switch closed' (see 'Binary input control' parameter)

Full stroke test (FST)

START-UP

Prerequisite
- Operating mode: Manual

Tolerance limit, Settling time before starting test,
Waiting time after step change, Sampling time
Activate ramp function

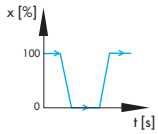
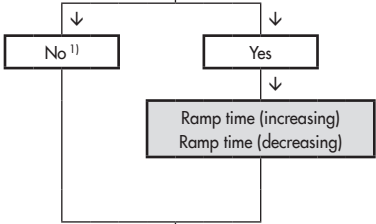
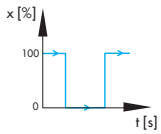

Cancelation condition

Max. test duration	Max. breakaway time	Perm. time until CLOSED position
--------------------	---------------------	----------------------------------

Status classification
PST/FST

Manual mode (TEST)

Solenoid valve triggered/forced venting active;
Control loop error; Set point start difference too high; Current too low; Supply pressure too low

Max. test duration exceeded

Start FST

The valve has not moved before reaching the max. breakaway time.

The valve has not reached the 'Stop' position before 'Perm. time until CLOSED position' has elapsed.

Analysis (NE 107)/logged by operating hours counter
PST/FST

Reset 'FST parameters'

¹⁾ Recommended

13 Full stroke test (FST)

The dynamic valve performance can be evaluated by performing this test.

The full stroke test is started in the manual mode.

The following listed parameters are activated while the full stroke test is being performed:

- Characteristic selection (Code 20): Linear
- Required transit time OPEN (Code 21): Variable
- Required transit time CLOSED (Code 22): Variable

During the full stroke test, the valve moves through its entire working range.

The first step ends in the fail-safe position. As a result, the second step starts from the fail-safe position.

The change in travel can be performed either in steps or in a ramp function (Fig. 20). For the test in a ramp function, additionally the times for the increasing and decreasing ramps need to be defined.

After being activated, the test does not start until the 'Settling time before starting test' has elapsed. This ensures that the valve has reached the start position.

Starting from the start position, the valve moves to the fail-safe position. The valve remains in this position for the time defined by the 'Waiting time after step change' before performing a second step change in the opposite direction from the fail-safe position to the start position of the first step. After the 'Waiting time after step change' has elapsed, the valve moves back to its operating point.

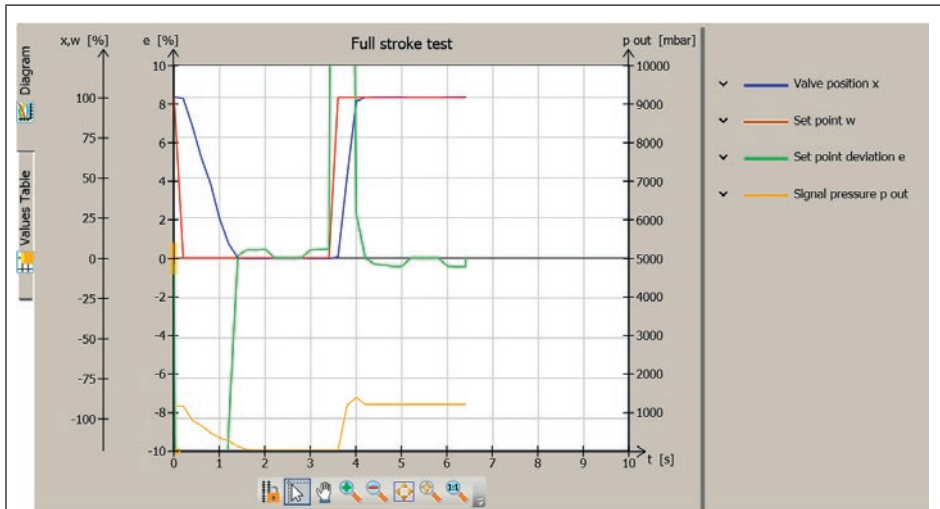

Fig. 19: Diagnostics > Monitoring/tests > Dynamic tests > Full stroke test (FST)

Full stroke test (FST)

The 'Tolerance limit' parameter defines the permitted valve positions for the start value and the end value for the step.

The 'Sampling time' defines the time interval between which the measured values are recorded during the test.

Test cancellation conditions

Various cancellation conditions provide additional protection against the valve slamming shut or moving past the end position. The positioner cancels the full stroke test when one of the following cancellation conditions is fulfilled:

- 'Max. test duration': The test is canceled when the maximum permissible test duration is reached.
- 'Max. breakaway time': The test is canceled when the time entered in 'Settling time before starting test' has elapsed and the valve has still not changed its position. This cancellation condition only becomes effective after it has been activated ("Activate 'Max. breakaway time' = [Yes]).

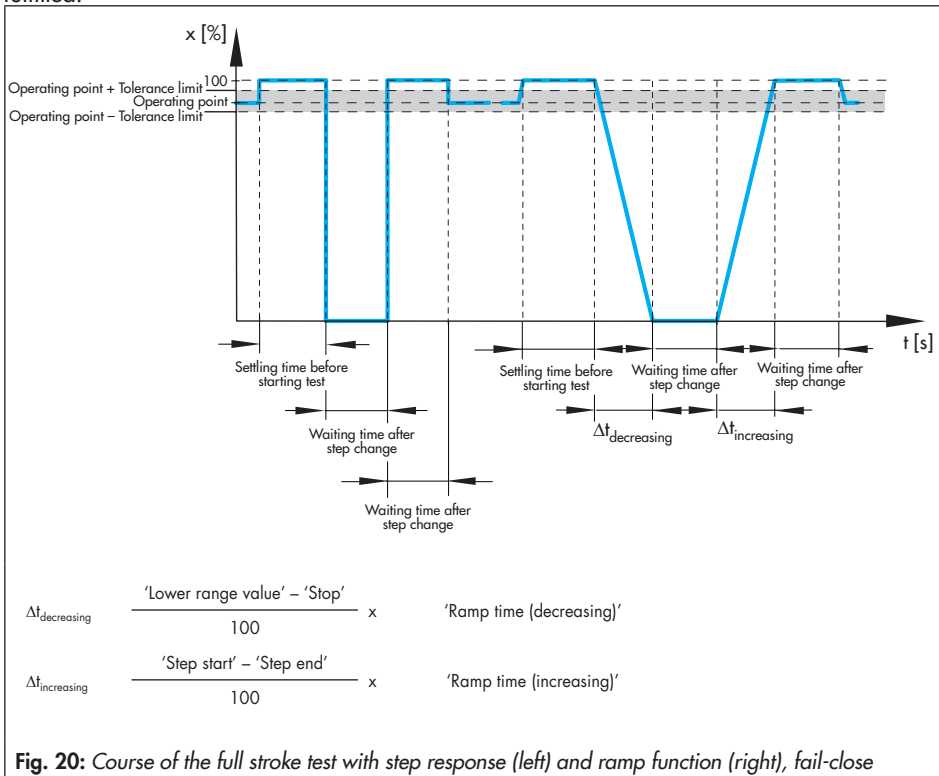

Fig. 20: Course of the full stroke test with step response (left) and ramp function (right), fail-close

- 'Perm. time until CLOSED position': The test is canceled when the valve does not reach the CLOSED position before the adjusted time has elapsed. This cancellation condition only becomes effective after it has been activated ("Activate 'Perm. time until step end" = [Yes]).

Additionally, the full stroke test is canceled when one of the following events arises:

- Cancel internal solenoid valve/forced venting: The test was canceled by the activation of the solenoid valve/forced venting function.
- Canceled by control loop error: A control loop error has occurred.
- Set point start difference too high: During the step change, 'Lower range value' is outside the range (operating point \pm 'Tolerance limit').
- Current too low
- Supply pressure too low

i Note

The 'Measured data storage out of memory' reading (Failure) is generated when the 'Sampling time' is too low. After recording 100 measured values per variable, logging is stopped, but the test continues until it is completed.

After the full stroke test is canceled, the 'FST status' reading indicates 'Not successful'. The reason for cancellation is marked by the 'Failure' message in the **Measured data assessment** folder (> Current test).

Defining parameters

1. Switch to manual mode (Code 0 = MAN).
2. Define parameters for full stroke test. See also ► *Note concerning setting the FST diagnostic parameters.*
3. Define parameters for cancellation conditions.
4. Select classification for status messages.
5. Start full stroke test.
The 'Test information' status indicates 'Test active'. 'D6' and 'TEST' are indicated in alternating sequence on the positioner display. 'Function check'  is activated as the condensed state.

Diagnostics > Service/maintenance > Operating mode

- Enter operating mode (Code 0): Manual

Diagnostics > Monitoring/tests > Dynamic tests > Full stroke test (FST)

2. - Tolerance limit: 0.1 to 10.0 %, [2.0 %]
 - Activate ramp function: [Yes], No
 - Settling time before starting test: [1] to 240 s
 - Waiting time after step change: [2.0] to 25.0 s
 - Sampling time: 0.2 to 250.0 s, [1.4 s]
 Only when the ramp function is activated:
 - Ramp time (increasing): 0 to 9999 s, [60 s]
 - Ramp time (decreasing): 0 to 9999 s, [60 s]
3. - Max. test duration: 30 to 25000 s, [140 s]
 - Activate 'Max. breakaway time': Yes, [No]
 - Max. breakaway time: 0.0 to 25000 s, [30.0 s]

Full stroke test (FST)

- Activate 'Perm. time until CLOSED position exceeded': Yes, [No]
- Perm. time until CLOSED position exceeded: 0.0 to 25000 s, [70.0 s]

Device settings > Alarm settings > Status classification > PST/FST

- Max. test duration exceeded: [⊗], [⊕], [⊗], [⚠]
- Test canceled manually: [⊗], [⊕], [⊗], [⚠]
- Measured data memory full: [⊗], [⊕], [⊗], [⚠]
- Cancel internal solenoid valve/forced venting: [⊗], [⊕], [⊗], [⚠]
- Canceled by control loop error: [⊗], [⊕], [⊗], [⚠]
- Set point start difference too high: [⊗], [⊕], [⊗], [⚠]
- Set point change: [⊗], [⊕], [⊗], [⚠]
- Current too low: [⊗], [⊕], [⊗], [⚠]
- Max. breakaway time exceeded: [⊗], [⊕], [⊗], [⚠]
- Perm. time until CLOSED position exceeded: [⊗], [⊕], [⊗], [⚠]
- Canceled by supply pressure: [⊗], [⊕], [⊗], [⚠]

Diagnostics > Monitoring/tests > Dynamic tests > Full stroke test (FST)

4. Start test

Note concerning setting the FST diagnostic parameters

- The 'Ramp time (increasing)' must be greater than the corresponding value for 'Min. transit time CLOSED' (Code 41) determined during initialization.

- The 'Ramp time (decreasing)' must be greater than the corresponding value for 'Min. transit time OPEN' (Code 40) determined during initialization.
- The 'Sampling time' must not be lower than the indicated 'Recommended min. sampling time'. The 'Recommended min. sampling time' is calculated from the 'Expected duration of test'.

13.1 Analysis and monitoring

The analysis of the last three full stroke tests are saved with a time stamp in the **FST measured data assessment** folder.

Test completed successfully

When a full stroke test has been completed successfully, the analyzed parameters are displayed separately for the increasing and decreasing characteristics.

Analysis of measured data (step response test):

- 'Overshooting' (relative to the step height) [%]
- 'Dead time' [s]
- 'T86' [s]
- 'Settling time' [s]

Analysis of measured data (ramp test):

- 'Overshooting' (relative to the step height) [%]

The results of the first full stroke test are used as the reference measurement.

i Note

Changes in the diagnostic parameters listed below affect the test. The results of the next following full stroke test is used as the new reference measurement:

- 'Activate ramp function'
- 'Ramp time (increasing)'
- 'Ramp time (decreasing)'
- 'Waiting time after step change'

Test not completed

If the test was not completed, the reason for cancelation is indicated in the corresponding reading by the 'Failure' message. The positioner generates a 'PST/FST' message with the selected status classification.

Diagnostics > Monitoring

– PST/FST status (Code 84): , , , 

i Note

The 'No test available' status remains active until a full stroke is completed successfully.

13.2 Resetting single status messages

The diagnostic parameters of the full stroke test are reset by selecting and executing the command 'Reset FST parameters'. The measured data analysis and the 'PST/FST status' message cannot be reset.

The positioner saves the measured data analysis of the last three full stroke tests. The analysis of the penultimate test is deleted when another test is performed.

Diagnostics > Service/maintenance > Reset

– Reset 'FST parameters'

14 SIL operator test

The SIL operator ensures that the safety function of the positioner is working. The safety function is based on the shutdown of the i/p converter (6, Fig. 22). This causes the pneumatic actuator to be vented and the valve to move to its fail-safe position.

Monitoring of the input signal

The i/p converter is switched off when the input signal of the positioner at terminals +11/-12 falls below 3.8 mA or 4.4 mA depending on the positioner version (a signal range of 4 to 20 mA is required). See Fig. 21.

Monitoring the voltage supply (version with forced venting and solenoid valve)

The i/p converter and the solenoid valve (when installed) are shut down whenever the voltage at terminals +81/-82 falls below 12 V (an input voltage of 24 V DC is required). See Fig. 21.

The SIL operator test checks the emergency shutdown by the integrated safety function (SIL). It can be started in the manual or automatic mode of control valves.

The positioner generates a permanent message in the event that an error occurs during the operator test. All control properties of the positioner remain kept. Only the emergency shutdown function of the positioner is no longer guaranteed.

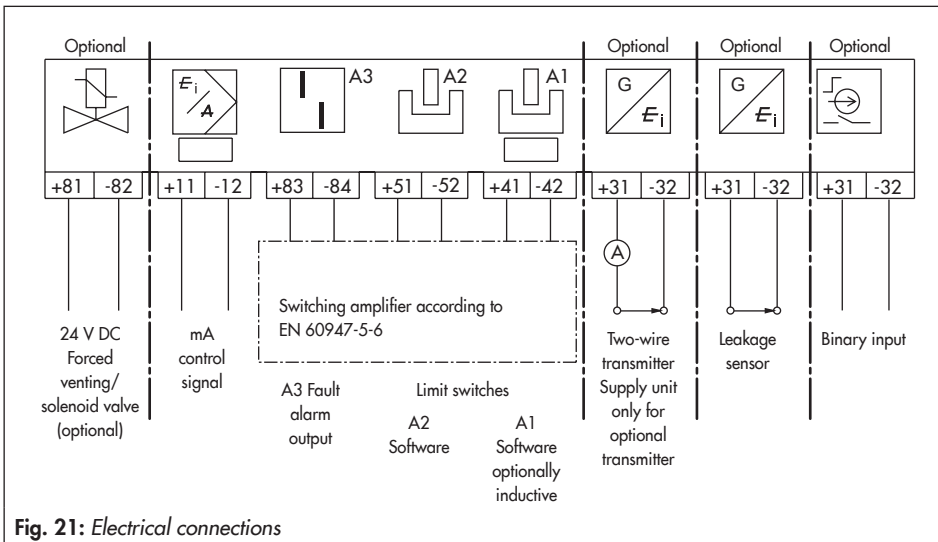
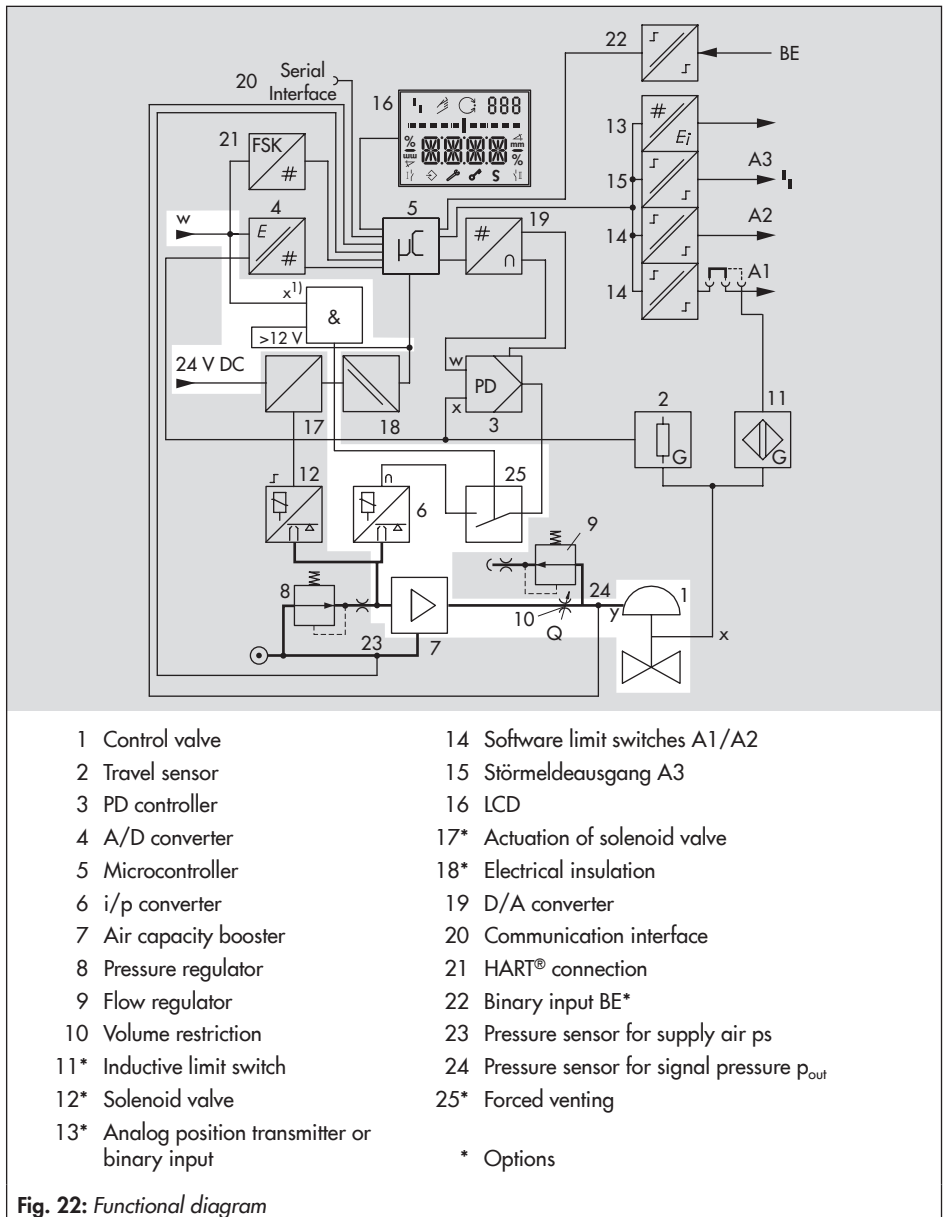

Fig. 21: Electrical connections



SIL operator test

NOTICE

The SIL operator test causes the valve to automatically move. It must only be started when the plant allows it.

Defining parameters

1. Set Type of application to Control valve.
2. Apply an external set point:
4.0 to 4.5 mA for 3.8 mA emergency shutdown
4.8 to 5.5 mA for 4.4 mA emergency shutdown
3. Start SIL operator test.
S001 to S030 appear on the positioner display one after the other.

Start-up

1. – Type of application (Code 49 - h0): **Control valve**

Diagnostics > Service/maintenance > SIL operator test

3. – Start SIL operator test

The emergency shutdown function of the positioner is no longer guaranteed. The positioner needs to be returned immediately to SAMSON.

Diagnostics > Service/maintenance > SIL operator test

- SIL test: 

14.1 Analysis and monitoring

SIL operator test completed successfully

OK appears on the positioner display.

SIL operator test not completed

Possible error code E001 to E030 appears on the positioner display. The positioner generates the permanent error code 86 (Failure - this status classification cannot be changed).

15 Binary input

TROVIS SAFE 3730-6xxxxx3x00x0x00

The positioner has an optional binary input to activate various functions:

- [Transmit switching state]
The switching state of the binary input is logged.
- Activate local write protection
After the first initialization, a local write protection can be activated. While the binary input is active, no settings can be changed at the positioner. The positioner cannot be restarted. Enabling configuration over Code 3 is not active.
- Start PST
The positioner starts a single partial stroke test. The test is performed using the settings in Code 49 - d2 to Code 49 - d9. See ► Section 12.
- Move valve to safety set point
An on/off valve moves to the predetermined safety set point when the positioner is in automatic mode. This function is not performed if the positioner is in the manual mode or fail-safe position mode.
- Switch AUTO/MAN
The positioner changes from the automatic mode to the manual mode or vice versa. This function is not performed if the positioner is in the fail-safe position mode.

- Start data logger
Activation of the binary input causes the data logger to start. See ► Section 3.
- Reset diagnostics
Active monitoring and dynamic tests are stopped and the diagnostic data is reset once.

 **Note:**
The optional binary input can only be configured using the TROVIS-VIEW 4 software and using the DD parameters. In the default setting, the switch state is logged with a closed switch.

Defining parameters

-  **Note**
- *The parameters can only be defined in TROVIS-VIEW 4 after the 'Positioner accessories identification' has been set to 'Binary input'.*
 - *The 'Safety set point' can only be set when the 'Type of application' is set to 'On/off valve'.*





-
1. Select 'Binary input' in 'Positioner accessories identification'.
 2. Configure the binary input.

Device settings > Positioner > Options

1. - Positioner accessories identification: Binary input

Binary input

Device settings > Positioner > Options > Configuration, binary input

2. – Binary input configuration: [For floating contact (switch function)], For non-floating contact (0-24 V)
 - Select function: [Transmit switching state], Activate local write protection, Start PST, Move valve to safety set point, Switch AUTO/MAN, Start data logger, Reset diagnostics
 - Binary input control: Activate function: switch open, [Activate function: switch closed]
 - Safety set point: 0.0 to 100.0 %, [50.0 %] (only when Type of application = On/off valve)
 - Binary input classification: [, , , 

16 Dynamic HART® variables

The HART® specification defines four dynamic variables consisting of a value and an engineering unit. These variables can be assigned to device parameters as required. The universal HART® command 3 reads the dynamic variables out of the device. This allows manufacturer-specific parameters to also be transferred using a universal command.

In the TROVIS SAFE 3730-6 Positioner, the dynamic variables can be assigned in the **Device settings** folder (> **Positioner** > **HART communication**) as listed in ► Table 5:

Device settings > Positioner > HART communication

- Primary variable assignment: [Set point], Direction of action set point, Set point after transit time specification, Valve position, Set point deviation e, Absolute total valve travel, Binary input status, Internal solenoid valve/forced venting status, Condensed state, Temperature, Leakage sensor sound level, Ambient pressure, Signal pressure p out, Supply pressure, Flow rate, Differential pressure, All active errors
- Secondary variable assignment: Set point, Direction of action set point, Set point after transit time specification, [Valve position], Set point deviation e, Absolute total valve travel, Binary input status, Internal solenoid valve/forced venting status, Condensed state, Temperature, Leakage sensor sound level, Ambient pressure, Signal pressure p out, Supply pressure, Flow rate, Differential pressure, All active errors

- Tertiary variable assignment: Set point, Direction of action set point, Set point after transit time specification, Valve position, [Set point deviation e], Absolute total valve travel, Binary input status, Internal solenoid valve/forced venting status, Condensed state, Temperature, Leakage sensor sound level, Ambient pressure, Signal pressure p out, Supply pressure, Flow rate, Differential pressure, All active errors
- Quaternary variable assignment: Set point, Direction of action set point, Set point after transit time specification, Valve position, Set point deviation e, [Absolute total valve travel], Binary input status, Internal solenoid valve/forced venting status, Condensed state, Temperature, Leakage sensor sound level, Ambient pressure, Signal pressure p out, Supply pressure, Flow rate, Differential pressure, All active errors

Dynamic HART® variables

Table 5: *Dynamic HART® variables assignment*

Variable	Meaning	Unit
Set point	Set point	%
Direction of action set point	Direction of action set point	%
Set point after transit time specification	Set point after transit time specification	%
Valve position	Valve position	%
Set point deviation e	Set point deviation e	%
Absolute total valve travel	Absolute total valve travel	–
Binary input status	0 = Not active 1 = Active 255 = –/–	–
Internal solenoid valve/forced venting status	0 = De-energized 1 = Energized 2 = Not installed	–
Condensed state	0 = No message 1 = Maintenance required 2 = Maintenance request 3 = Failure 4 = Out of specification 7 = Function check	–
Temperature	Temperature	°C
Leakage sensor sound level	Leakage sensor sound level	dB
Ambient pressure	Ambient pressure	mbar
Signal pressure p _{out}	Signal pressure p _{out}	bar
Supply pressure	Supply pressure	bar
Flow rate	Flow rat	m ³ /h
Differential pressure	Differential pressure	bar
All active errors	0 = No errors 1 = Control loop 2 = Zero 4 = w too low 8 = PST/FST status 16 = On/off error activated 32 = SIL test 64 = Set point outside range 128 = Total valve travel exceeded 256 = Operating mode not AUTO	–

17 Appendix

17.1 Code list

Code no.	Parameter – Readings/ values [default setting]	Description
Note: Codes with marked with an asterisk (*) must be enabled with Code 3 prior to configuration.		
48*	Diagnostic parameters	
	d0 Temperature Read only	Current operating temperature [°C] inside the positioner (accuracy ±3 %)
	d1 Min. temperature Read only	Lowest temperature [°C] recorded inside the positioner since starting the operating hours counter
	d2 Max. temperature Read only	Highest temperature [°C] recorded inside the positioner since starting the operating hours counter
	d3 No. of zero calibrations Read only	The number of zero calibrations performed since last initialization
	d4 No. of initializations Read only	Number of initializations performed since last start with default values
	d5* Zero limit 0.0 to 100.0 %, [5.0 %] of the nominal range, ESC	Valve position limit relating to nominal range 'Zero point' message (Code 58) triggered depending on selected status classification if limit is exceeded. Note: The 'Zero point' message (Code 58) has the default status classification 'Maintenance required'. This classification can only be changed in the operator software (e.g. TROVIS-VIEW).
d6 Condensed state Read only	Summary of all status messages classified according to NAMUR Recommendation NE 107 OK: No message C: Maintenance required CR: Maintenance demanded S: Out of specification B: Failure I: Function check	

Code no.	Parameter – Readings/values [default setting]	Description
Note: Codes with marked with an asterisk (*) must be enabled with Code 3 prior to configuration.		
48*	d7 Supply pressure p_s Read only	Current supply pressure [bar]
	d8 Signal pressure p_{out} Read only	Current signal pressure [bar]
	d9 Flow rate Read only	Current valve flow rate Note: – – – – appears on the display when the flow rate calculation is not active or has failed.
	d10 Differential pressure Read only	Current differential pressure [bar]
	d11* Direction of action (actuator) [-/-], SA, DA, ELSE, ESC	Indicates the actuator's direction of action SA: Single-acting DA: Double-acting ELSE: Other
	Diagnostic parameters h	
h0* Initialization including valve signature No, [YES], ESC	Initialization with [YES] or without [No] plotting the valve signature The valve signature involves the signal pressure p_{out} being plotted in relation to the valve position. Regardless of the adjusted settings, the valve signature is recorded automatically when initializing a positioner that has not yet been initialized (e.g. after initialization was reset (Code 36 - Std and Code 36 - DS)), after each further initialization if the settings for 'Initialization mode', 'Pin position', 'Direction of action', 'Pressure limit', 'Proportional-action coefficient K_p level' or 'Derivative-action time T_v level' were changed, and when the switch position (ATO/ATC) was changed. Note: The valve signature is required to perform diagnostic functions.	
h1, h2	Unassigned	

Code no.	Parameter – Readings/ values [default setting]	Description
Note: Codes with marked with an asterisk (*) must be enabled with Code 3 prior to configuration.		
48*	h3* Desired time until 'Reset measured diagnostic data' [0] to 365 days, ESC	Time interval for scheduled resetting of measured diagnostic data
	h4 Remaining time until 'Reset measured diagnostic data' Read only	Remaining time (time and unit of time displayed in alternating sequence) until the next scheduled reset of the diagnosis data
49*	Partial stroke test (PST)	
	A Partial stroke test (PST)	
	A0* Start test [No], YES, ESC	Starts partial stroke test (test D4). The valve moves through the test range (Lower range value (Code 49 - d2) to Upper range value (Code 49 - d3)) and back again in a ramp or in steps. Recorded variables: time, set point, valve position, set point deviation, control signal.
	A1 Time until next test Read only	Remaining time (time and unit of time displayed in alternating sequence) until the the next time-controlled test starts
	A2* Test start AUTO, [MAN], ESC <i>The write protection is active in the AUTO setting (local operation and operation over software locked).</i>	Activates (AUTO) or deactivates (MAN) the time-controlled partial stroke test.
	A3* Test interval	Time interval (time and unit of time displayed in alternating sequence) between time-controlled tests
	A4	Unassigned
A5 Recommended min. sampling time Read only	Sampling time [s] used to record entire step response in the graph of the partial stroke test	

Code no.	Parameter – Readings/values [default setting]	Description
Note: Codes with marked with an asterisk (*) must be enabled with Code 3 prior to configuration.		
49*	A6	Unassigned
	A7 Δp_{out} reference value Read only	The valve moves to the lower range value (Code 49 - d2) and upper range value (Code 49 - d3) with a certain signal pressure. These signal pressures are used to form the Δp_{out} reference value [bar]. Note: <i>The reference value only applies to the adjusted step and ramp values.</i>
	A8* Activate Δp_{out} monitoring [NO], YES, ESC	Activates Δp_{out} monitoring (YES) or deactivates it (No)
	A9* Δp_{out} monitoring value 0.00 to 7.00 bar, [1.00 bar,] ESC	Test canceled if signal pressure change exceeds or falls below the reference value. The reference value is made up of Δp_{out} reference value Δp_{out} reference value (Code 49 - A7) and the Δp_{out} monitoring value.
d Step parameters for the partial stroke test (PST)		
	d0, d1	Unassigned
	d2* Lower range value 0.0 to [100.0] %, ESC	Start value of the test range Note: <i>To perform a partial stroke test, the 'Lower range value' must be near the current operating point \pm 'Tolerance limit'. The Tolerance limit is 2.0 % by default. It can be changed in the operator software, e.g. TROVIS-VIEW.</i>
	d3* Upper range value 0.0 to 100.0 %, [90.0 %], ESC	End value of the test range
	d4* Activation of ramp function No, [YES]	YES: The valve is moved through the test range within the adjusted ramp time. No: The valve is moved in steps through the test range (step response).
	d5* Ramp time (decreasing) 0 to 9999 s, (600 s), ESC	The time required by the valve to move through the range from CLOSED to OPEN position. The time to move from Lower range value (Code 49 - d2) to Upper range value (Code 49 - d3) is calculated: $ \text{Upper range value} - \text{Lower range value} / 100 \times \text{Ramp time (increasing)}$





Code no.	Parameter – Readings/ values [default setting]	Description
Note: Codes with marked with an asterisk (*) must be enabled with Code 3 prior to configuration.		
49*	d6* Ramp time (increasing) 0 to 9999 s, [60 s], ESC	The time required by the valve to move through the range from OPEN to CLOSED position. The time to move from Upper range value (Code 49 - d3) to Lower range value (Code 49 - d2) is calculated: $ \text{Lower range value} - \text{Upper range value} / 100 \times \text{Ramp time (decreasing)}$
	d7* Settling time before starting test 1 to 240 s, [2 s], ESC	Settling time between reaching the upper range value (Code 49 - d3) and the valve moving through the test range in the reverse direction
	d8* Waiting time after step change 1.0 to 240.0 s, [2.0 s], ESC	Waiting time between step change from Lower range value (Code 49 - d2) to Upper range value (Code 49 - d3) and vice versa ^{sa}
	d9* Sampling time 0.2 to 250.0 s, [0.8 s], ESC	Interval for measured data recording
	E Cancellation conditions of the partial stroke test (PST)	
E0* Activate x monitoring No, [YES]	Activates x monitoring (YES) or deactivates it (No)	
E1* x monitoring value -10.0 to 110.0 %, [85.0 %] of total travel, ESC	The test is canceled when the valve position - falls below the adjusted value (step end < step start) - exceeds the adjusted value (step end > step start)	
E2, E3, E4	Unassigned	
E5* Activate PST tolerance band monitoring [No], YES	Activates PST tolerance band monitoring (YES) or deactivates it (No)	
E6* PST tolerance band 0.1 to 100.0 %, [5.0 %], ESC	The test is canceled when the valve position's deviation (relating to step end) exceeds the adjusted value.	







Appendix

Code no.	Parameter – Readings/values [default setting]	Description
Note: Codes with marked with an asterisk (*) must be enabled with Code 3 prior to configuration.		
49*	E7* Max. test duration 30 to 25000 s, [90 s], ESC	Test canceled when max. test duration is reached.
	E8	Unassigned
	E9* Reset 'PST parameters'	Resets partial stroke test parameters.
	F Partial stroke test (PST) information - Read only	
	F0 No test available	
	F1	Unassigned
	F2 x cancelation	The test was canceled. The valve position fell below the x monitoring value (Code 49 - E1).
	F3 Δp_{out} cancelation	The test was canceled. The signal pressure change Δp_{out} exceeded or fell below the reference value.
	F4 Tolerance band exceeded	The valve position deviation exceeds the PST tolerance band (Code 49 - E6).
	F5 Max. test duration exceeded	The test was canceled. The Max. test duration (Code 49 - E7) was reached.
	F6 Test canceled manually	
	F7 Measured data memory full	The Sampling time (Code 49 - d9) is too low. After recording 100 measured values per variable, logging is stopped, but the test continues until it is completed.
	F8 Cancel internal solenoid valve/forced venting	The test was canceled. The internal solenoid valve has been energized/the forced venting has been activated.









Code no.	Parameter – Readings/ values [default setting]	Description
Note: Codes with marked with an asterisk (*) must be enabled with Code 3 prior to configuration.		
	F9 Canceled by control loop error	The test was canceled. A control loop error has occurred.
49*	h Type of application	Note: Section 7.8 contains details on the on/off valve.
	h0 Type of application No, [YES], ESC	No Control valve YES On/off valve Depending on the adjusted type of application, the positioner responds differently in automatic mode and there are differences in the diagnostic functions. See section 3.4.
	h1 Operating point 0.0 to [100.0] % valve position, ESC	Valve position if set point $w >$ Operating point limit (Code 49 - h5)
	h2 Fail-safe action limit 0.0 to 20.0 % [12.5 %] of the set point, ESC	Limit of the set point w A limit violation causes the valve to move to the fail-safe position.
	h3 Lower limit to start test [25.0 % of the set point]	If the set point is between Lower limit to start test (25 %) and Fail-safe action limit (Code 49 - h2), the valve remains in its last valid position. If the set point remains between Lower limit to start test (25 %) and Upper limit to start test (50 %) for six seconds, a partial stroke starts. After the partial stroke test is completed, the valve moves back to the last valid position.
	h4 Upper limit to start test [50.0 % of the set point]	If the set point is between Operating point limit and Upper limit to start test (50 %), the valve remains in its last valid position. If the set point remains between Lower limit to start test (25 %) and Upper limit to start test (50 %) for six seconds, a partial stroke starts. After the partial stroke test is completed, the valve moves back to the last valid position.
	h5 Operating point limit 55.0 to 100.0 %, [75.0 %] of the set point, ESC	Limit of the set point w A limit violation causes the valve to move to the Operating point (Code 49 - h1).

















17.2 Error messages and recommended corrective action

Message	Possible reasons	Recommended action	Status classification	Single reset
Diagnostics > Monitoring > Positioner				
Control loop (Code 57)	<ul style="list-style-type: none"> – Actuator is blocked. – Positioner attachment has shifted subsequently. – Insufficient supply pressure 	<ul style="list-style-type: none"> – Check attachment. – Check supply pressure. 	<ul style="list-style-type: none"> • 	–
Zero point (Code 58)	<ul style="list-style-type: none"> – Mounting arrangement or linkage has slipped. – Valve trim, particularly with soft seat, is worn. 	<ul style="list-style-type: none"> – Check valve and positioner attachment. – Calibrate zero. <p>We recommend to re-initialize the positioner if zero deviates by more than 5 %.</p>	<ul style="list-style-type: none"> • 	•
Inconsistent data memory (Code 59)	The error is detected by automatic monitoring and corrected automatically.		–	•
Internal device error (Code 60)	– Electromagnetic interference	<ul style="list-style-type: none"> – Reset initialization. – Re-initialize positioner. 	–	•
Kp too low (Code 61)	Proportional-action coefficient Kp level lower than 3 was detected during initialization.	– Activate volume restriction in positioner output.	<ul style="list-style-type: none"> • 	•
x signal (Code 62)	<ul style="list-style-type: none"> – Actuator's measured value recording failed. – Conductive plastic element defective. 	– Return positioner to SAMSON for repair.	–	–
w too small (Code 63)	<ul style="list-style-type: none"> – The set point (w) is lower than 3.7 mA. <p>This state is indicated on the positioner display by LOW blinking.</p>	– Check set point (w). If necessary, restrict lower limit of current source to ensure that a current below 3.7 mA cannot be issued.	<ul style="list-style-type: none"> • 	–
i/p converter (Code 64)	Current circuit of i/p converter interrupted.	Return positioner to SAMSON for repair.	–	–
Hardware (Code 65)		Confirm error and select 'Automatic' operating mode. If not successful, reset initialization and re-initialize the positioner.	–	•
Control calculation (Code 67)		Confirm error. If this is not possible, return positioner to SAMSON for repair.	–	•
Pressure sensor (Code 72)	Pressure sensor(s) for supply air and/or signal pressure defective	Return positioner to SAMSON for repair.	–	–



Message	Possible reasons	Recommended action	Status classification	Single reset
Collective error (Code 79)	Messages generated in EXPERTplus	–	–	–
SIL test (Code 86)	SIL operator test failed	Return positioner to SAMSON for repair.	–	–
Set point outside range	Set point smaller than 4 mA or greater than 20 mA.	If possible, limit current source at lower (4 mA) and/or upper (20mA) limit.	–	–
Binary input status	Binary input is active		–	–
Temperature status	– Temperature fallen below $-40\text{ }^{\circ}\text{C}$ – Temperature exceeded $+80\text{ }^{\circ}\text{C}$		• 	–
x > range (Code 50)	– Pin not mounted properly. – NAMUR attachment: bracket slipped or follower pin not properly seated on the follower plate's slot. – Follower plate not mounted properly.	– Check attachment and pin position. – Re-initialize positioner.	• 	•
$\Delta x <$ range (Code 51)	– Pin not mounted properly. – Wrong lever mounted. – Pressure limit set too low.	– Check attachment and pressure limit. – Re-initialize positioner.	• 	•
Attachment (Code 52)	– Wrong lever mounted. – Supply pressure too low; valve cannot be moved to desired position. – Nominal range could not be reached during nominal range initialization (NOM).	– Check attachment and supply pressure. – Re-initialize positioner.	• 	•
Initialization time exceeded (Code 53)	Timeout detected during initialization – Valve takes too long to open. – Valve cannot find fixed end stops (e.g. when lined control butterfly valves are used). – Valve tends to hunt considerably.	– Check supply pressure and install pneumatic volume booster, if necessary. – Adjust travel/angle stops. – Reduce hunting tendency (e.g. restrict or open booster bypass). Then re-initialize the positioner.	• 	•
Internal solenoid valve/forced venting/supply pressure (Code 54)	Internal solenoid valve/forced venting not or improperly connected.	– Check connection and supply voltage of solenoid valve/forced venting. – Re-initialize positioner.	• 	•
	An attempt was made to initialize the device from fail-safe position.	– Switch to manual mode. – Re-initialize positioner.		

Appendix

Message	Possible reasons	Recommended action	Status classification	Single reset
Transit time not reached (Code 55)	Actuator transit times detected during initialization are so short (< 0.3 s) that optimal positioner tuning is impossible.	<ul style="list-style-type: none"> – Activate volume restriction in positioner output. – Re-initialize positioner. 	<ul style="list-style-type: none"> • 	<ul style="list-style-type: none"> •
Pin/switch position (Code 56)	Pin position not entered for nominal range (NOM) or substitute (SUB) initialization.	<ul style="list-style-type: none"> – Enter pin position and nominal range. – Re-initialize positioner. 	<ul style="list-style-type: none"> • 	<ul style="list-style-type: none"> •
	ATO/ATC switch defective.	Return positioner to SAMSON for repair.		
No emergency mode (Code 76)	Positioner detected during initialization that actuator permits no emergency control mode without feedback. In case of a travel sensing error, positioner vents Output or A1 in double-acting actuators.	For your information only. No further action required.	<ul style="list-style-type: none"> • 	–
Valve signature canceled (Code 81)	Error while recording valve signature. Refer to section	Restart the valve signature recording or start initialization including valve signature.	<ul style="list-style-type: none"> • 	–
Diagnostics > Monitoring > Valve				
Change in friction	<ul style="list-style-type: none"> – The friction is higher/lower in total range – The friction is higher/lower in valve's mid-position. – The friction is higher/lower near valve's max. OPEN position. – The friction is higher/lower near valve's CLOSED position. 	<ul style="list-style-type: none"> – Check the valve's packing. 	<ul style="list-style-type: none"> • 	<ul style="list-style-type: none"> •
Seat leakage	– Alarm limit 2 or 3 exceeded.	<ul style="list-style-type: none"> – Check seat and plug. 	<ul style="list-style-type: none"> • 	<ul style="list-style-type: none"> • <ul style="list-style-type: none"> ▶ Sec. 9.1.2.4
	– Seat leakage may exist.		<ul style="list-style-type: none"> • <ul style="list-style-type: none"> ▶ Sec. 7.2 	
Packing leakage	– Packing leakage is possibly to be expected soon.	<ul style="list-style-type: none"> – Check the valve's packing. 	<ul style="list-style-type: none"> • 	<ul style="list-style-type: none"> • <ul style="list-style-type: none"> ▶ Sec. 8.2
Total valve travel exceeded	– 'Absolute total valve travel' exceeded 'Total valve travel limit'.		<ul style="list-style-type: none"> • 	–
Diagnostics > Monitoring > Actuator				
Pneumatic leakage	– A leak in the pneumatics exists.	<ul style="list-style-type: none"> – Check that pneumatic installations and connections are tight. 	<ul style="list-style-type: none"> • 	–

Message	Possible reasons	Recommended action	Status classification	Single reset
Defective actuator springs	<ul style="list-style-type: none"> The actuator spring pre-loading is reduced. 	<ul style="list-style-type: none"> Check actuator springs. 	<ul style="list-style-type: none">  	<ul style="list-style-type: none">  Sec. 4.5
Supply pressure status	<ul style="list-style-type: none"> The supply pressure is outside permissible limits. 	<ul style="list-style-type: none"> Check supply pressure. 	<ul style="list-style-type: none">  	<ul style="list-style-type: none">  Sec. 4.5
	<ul style="list-style-type: none"> The supply pressure is too high. 		<ul style="list-style-type: none">  	
	<ul style="list-style-type: none"> The supply pressure fluctuates. 		<ul style="list-style-type: none">  	
	<ul style="list-style-type: none"> The supply pressure is too low. 		<ul style="list-style-type: none">  	
	<ul style="list-style-type: none"> No supply pressure is available. 		<ul style="list-style-type: none">  	
Diagnostics > Monitoring > Valve position				
Manipulated variable range limitation	<ul style="list-style-type: none"> The working range is limited at upper or lower range value. The valve is jammed. 	<ul style="list-style-type: none"> Check that pneumatic installations and connections are tight. Check supply pressure. Check plug stem for external influences that could be blocking it. 	<ul style="list-style-type: none">  	<ul style="list-style-type: none">  Sec. 7.2
Course of end position	<ul style="list-style-type: none"> Course of end position monotonically increasing/decreasing. The course of end position alternates. 	<ul style="list-style-type: none"> Check seat and plug. 	<ul style="list-style-type: none">  	<ul style="list-style-type: none">  Sec. 10.2
Positioner-valve linkage	<ul style="list-style-type: none"> No optimal travel transmission. The working range is limited. 	<ul style="list-style-type: none"> Check attachment. 	<ul style="list-style-type: none">  	<ul style="list-style-type: none">  Sec. 7.2
Manipulated variable range	<ul style="list-style-type: none"> The working range is mainly close to the CLOSED/max. OPEN position. The working range is mainly in the CLOSED/max. OPEN position. 	<ul style="list-style-type: none"> Rethink the working range. 	<ul style="list-style-type: none">  	<ul style="list-style-type: none">  Sec. 6.2

Appendix

Message	Possible reasons	Recommended action	Status classification	Single reset
Change in manipulated variable range	<ul style="list-style-type: none"> - The working range has shifted towards CLOSED or max. OPEN position. - Short-term change of manipulated variable range occurred. 	<ul style="list-style-type: none"> - Rethink the working range. 	<ul style="list-style-type: none"> • 	<ul style="list-style-type: none"> • <ul style="list-style-type: none"> ▶ Sec. 6.2
Diagnostics > Monitoring				
PST/FST status Status (Code 84)	<ul style="list-style-type: none"> - The partial stroke test or the full stroke test has not been completed successfully. 	<ul style="list-style-type: none"> - Read test status. See section 12/13. 	<ul style="list-style-type: none"> • 	<ul style="list-style-type: none"> -
On/off valve (Code 85)	<ul style="list-style-type: none"> - The breakaway time or transit time differs from the reference value by the amount entered in 'Travel time assessment limit'. - The valve end position differs from reference value by the amount entered in 'Valve end position limit'. - The valve end position cannot be reached. 	<ul style="list-style-type: none"> - Check valve and actuator. 	<ul style="list-style-type: none"> • 	<ul style="list-style-type: none"> • <ul style="list-style-type: none"> ▶ Sec. 5.3

17.3 Diagnostic data points saved in a non-volatile memory

	Data saved in a non-volatile memory	
	Saved directly after they change	Saved cyclically every 24 h
Monitoring	<ul style="list-style-type: none"> – Status classification – Alarm settings – Logging 	
Data logger	Diagnostic parameters	
Valve signature	<ul style="list-style-type: none"> – Diagnostic parameters – Manufacturer reference – Process reference 	Measured values Long-term monitoring Sound level(x)
On/off valve	Reference assessment	Assessment
Valve position x histogram	Diagnostic parameters	Measured data in histogram
Set point deviation e histogram	Diagnostic parameters	Measured data in histogram
Cycle counter histogram		Measured data in histogram
Lower end position	Measured values	
Valve dead band		
Partial stroke test (PST)	<ul style="list-style-type: none"> – Diagnostic parameters – Test cancelation conditions – Δp out reference value – Course of step response – Measured data assessment – Number of tests 	
Full stroke test (FST)	<ul style="list-style-type: none"> – Diagnostic parameters – Test cancelation conditions – Δp out reference value – Course of step response – Measured data assessment – Number of tests 	

17.4 Resetting parameters

Parameters	Reset Code 36		
	Diag	Std	DS
Start-up			
Type of application (Code 49 - h0)	YES	YES	YES
Reading direction (Code 2)	NO	YES	YES
Initialization mode (Code 6)	NO	YES	YES
Initialization including valve signature (Code 48 - h0)	NO	YES	YES
Pin position (Code 4)	NO	YES	YES
Enter nominal range	NO	YES	YES
Pressure limit (Code 16)	NO	YES	YES
Actuator motion	NO	NO	YES
Principle of operation (Code 48 - d11)	NO	NO	YES
Stem seal	NO	NO*	YES
* Max. cycle count is set to 1000000			
Start-up > Fail-safe action			
Air supply failure	NO	NO	YES
Power supply failure of positioner	NO	NO	YES
Power supply failure of external solenoid valve	NO	NO	YES
Emergency mode	NO	NO	NO
Start-up > Control parameters			
Proportional-action coefficient Kp level (Code 17)	NO	NO	NO
Derivative-action time Tv level (Code 18)	NO	NO	NO
Start-up > Substitute calibration			
Initialization mode (Code 6)	NO	YES	YES
Activate upper limit for travel/angle (Code 11)	NO	YES	YES
Direction of action (Code 7)	NO	YES	YES
Proportional-action coefficient Kp level (Code 17)	NO	NO	NO
Derivative-action time Tv level (Code 18)	NO	NO	NO
Substitute calibration optimization	NO	YES	YES

Parameters	Reset Code 36		
	Diag	Std	DS
Start-up > Reference graphs > Valve signature			
Sensitivity	YES	YES	YES
Start-up > Reference graphs > Leakage sensor > Manufacturer reference			
Settling time before sound level measurement	NO	NO	NO
Sensitivity sound level	NO	NO	YES
Set points	NO	NO	YES
Start-up > Reference graphs > Leakage sensor > Process reference			
Settling time before sound level measurement	NO	NO	NO
Sensitivity sound level	NO	NO	YES
Response time	NO	NO	YES
Preset alarm limits	NO	NO	YES
Alarm limits 1 to 3	NO	NO	YES
Set points	NO	NO	YES
Device settings > Positioner			
Attachment	NO	NO	YES
Inductive limit switch (Code 38)	NO	NO	NO
Device settings > Positioner > Transfer characteristic			
Direction of action (Code 7)	NO	YES	YES
Lower set point range value (Code 12)	NO	YES	YES
Upper set point range value (Code 13)	NO	YES	YES
Activate CLOSED end position (Code 14)	NO	YES	YES
CLOSED end position (Code 14)	NO	YES	YES
Activate OPEN end position (Code 15)	NO	YES	YES
OPEN end position (Code 15)	NO	YES	YES
Enter transit time OPEN (Code 21)	NO	YES	YES
Enter transit time CLOSED (Code 22)	NO	YES	YES
Lower travel/angle range value	NO	YES	YES

Parameters	Reset Code 36		
	Diag	Std	DS
Upper travel/angle range value (Code 9)	NO	YES	YES
Activate lower travel/angle limit (Code 10)	NO	YES	YES
Lower travel/angle limit (Code 10)	NO	YES	YES
Activate upper limit for travel/angle (Code 11)	NO	YES	YES
Upper limit for travel/angle (Code 11)	NO	YES	YES
Select characteristic (Code 20)	NO	YES	YES
User-defined characteristic	NO	YES	YES
Device settings > Positioner > Transfer characteristic on/off			
Activate CLOSED end position (Code 14)	NO	<p>The type of application is reset to 'On/off valve'.</p> <p>The Transfer characteristic on/off folder is not displayed after resetting.</p> <p>Parameters of the Transfer characteristic on/off folder are reset to their default settings.</p>	
CLOSED end position (Code 14)	NO		
Activate OPEN end position (Code 15)	NO		
OPEN end position (Code 15)	NO		
Enter transit time OPEN (Code 21)	NO		
Enter transit time CLOSED (Code 22)	NO		
Operating point (Code 49 - h1)	NO		
Fail-safe action limit (Code 49 - h2)	NO		
Operating point limit (Code 49 - h5)	NO		
Device settings > Positioner > HART communication			
Bus address (Code 46)	NO	NO	YES
Enter no. of preambles	NO	NO	YES
Primary variable assignment	NO	NO	YES
Secondary variable assignment	NO	NO	YES
Tertiary variable assignment	NO	NO	YES
Quaternary variable assignment	NO	NO	YES
HART® write protection	NO	NO	YES
Device settings > Valve			
Valve manufacturer	NO	NO	YES
Actuator motion	NO	NO	YES

Parameters	Reset Code 36		
	Diag	Std	DS
Valve design	NO	NO	YES
Type designation	NO	NO	YES
Valve serial no.	NO	NO	YES
Configuration ID (Var.-ID)	NO	NO	YES
Valve standard	NO	NO	YES
Nominal size DN	NO	NO	YES
Flow direction	NO	NO	YES
Stem seal	NO	NO	YES
Packing type	NO	NO	YES
Friction coefficient of packing	NO	NO	YES
Pressure balancing	NO	NO	YES
Facing (leakage class)	NO	NO	YES
Friction coefficient of facing	NO	NO	YES
Bellows seal	NO	NO	YES
Valve seat diameter	NO	NO	YES
Kvs	NO	NO	YES
Kvs unit	NO	NO	YES
Plug type	NO	NO	YES
Valve characteristic	NO	NO	YES
Noise reduction	NO	NO	YES
Device settings > Actuator			
Actuator manufacturer	NO	NO	YES
Actuator motion	NO	NO	YES
Actuator type	NO	NO	YES
Type designation	NO	NO	YES
Principle of operation (Code 48 - d11)	NO	NO	YES
Configuration ID (Var.-ID)	NO	NO	YES
Actuator serial no.	NO	NO	YES

Parameters	Reset Code 36		
	Diag	Std	DS
Effective actuator area	NO	NO	YES
Lower signal pressure range value	NO	NO	YES
Upper signal pressure range value	NO	NO	YES
Actuator fail-safe action	NO	NO	YES
Min. process pressure	NO	NO	YES
Max. process pressure	NO	NO	YES
Supply pressure	NO	NO	YES
Supply medium	NO	NO	YES
Device settings > Further accessories			
Filter regulator	NO	NO	YES
Reversing amplifier	NO	NO	YES
Booster	NO	NO	YES
Quick exhaust valve	NO	NO	YES
3/2-way valve	NO	NO	YES
Choke valve	NO	NO	YES
Lock-up valve	NO	NO	YES
Limit switch	NO	NO	YES
External solenoid valve	NO	NO	YES
Device settings > Process data			
State of process medium	NO	NO	YES
Constant pressure level at	NO	NO	YES
Input pressure p1	NO	NO	NO
Output pressure p2	NO	NO	NO
Inlet temperature	NO	NO	NO
Inlet density	NO	NO	NO
Isentropic exponent	NO	NO	YES

Parameters	Reset Code 36		
	Diag	Std	DS
Device settings > Process data > Min. operating point			
Input pressure p1	NO	NO	YES
Flow rate	NO	NO	YES
Output pressure p2	NO	NO	YES
Inlet temperature	NO	NO	YES
Inlet density	NO	NO	YES
Vapor pressure	NO	NO	YES
Critical pressure	NO	NO	YES
Isentropic exponent	NO	NO	YES
Compressibility factor	NO	NO	YES
Viscosity	NO	NO	YES
Flow coefficient	NO	NO	YES
Outlet velocity	NO	NO	YES
Relative travel/angle	NO	NO	YES
Differential pressure ratio	NO	NO	YES
Sound pressure level	NO	NO	YES
Device settings > Process data > Normal operating point			
Input pressure p1	NO	NO	NO
Flow rate	NO	NO	YES
Output pressure p2	NO	NO	NO
Inlet temperature	NO	NO	NO
Inlet density	NO	NO	NO
Vapor pressure	NO	NO	YES
Critical pressure	NO	NO	YES
Isentropic exponent	NO	NO	YES
Compressibility factor	NO	NO	YES
Viscosity	NO	NO	YES
Flow coefficient	NO	NO	YES

Appendix

Parameters	Reset Code 36		
	Diag	Std	DS
Outlet velocity	NO	NO	YES
Relative travel/angle	NO	NO	YES
Differential pressure ratio	NO	NO	YES
Sound pressure level	NO	NO	YES
Device settings > Process data > Max. operating point			
Input pressure p1	NO	NO	YES
Flow rate	NO	NO	YES
Output pressure p2	NO	NO	YES
Inlet temperature	NO	NO	YES
Inlet density	NO	NO	YES
Vapor pressure	NO	NO	YES
Critical pressure	NO	NO	YES
Isentropic exponent	NO	NO	YES
Compressibility factor	NO	NO	YES
Viscosity	NO	NO	YES
Outlet velocity	NO	NO	YES
Flow coefficient	NO	NO	YES
Relative travel/angle	NO	NO	YES
Differential pressure ratio	NO	NO	YES
Sound pressure level	NO	NO	YES
Device settings > Alarm settings			
Tolerance band (Code 19)	NO	YES	YES
Zero limit (Code 48 - d5)	NO	YES	YES
Lag time	NO	YES	YES
Leakage limit	NO	NO	YES
Travel time assessment limit (on/off valve)	NO	The type of application is reset to 'On/off valve'.	
Travel assessment limit (on/off valve)	NO		

Parameters	Reset Code 36		
	Diag	Std	DS
Total valve travel limit (Code 24)	NO	YES	YES
Stem seal	NO	NO	YES
Alarm mode (Code 25)	NO	YES	YES
Activate limit A1 and A2	NO	YES	YES
Limit A1 and A2 (Code 26 and 27)	NO	YES	YES
Error message in case of ... (Code 32 and 33)	NO	YES	YES
Permit 'More status available' bit	NO	NO	YES
Condensed state ... activates	NO	NO	NO
Recording threshold	YES	YES	YES
Activate lower limit	NO	YES	YES
Lower limit	NO	YES	YES
Activate upper limit	NO	YES	YES
Upper limit	NO	YES	YES
Device settings > Alarm settings > Status classification > Positioner			
All classifications	NO	NO	YES
Device settings > Alarm settings > Status classification > Valve			
All classifications	NO	NO	YES
Device settings > Alarm settings > Status classification > Actuator			
All classifications	NO	NO	YES
Device settings > Alarm settings > Status classification > Valve position			
All classifications	NO	NO	YES
Device settings > Alarm settings > Status classification > PST/FST			
All classifications	NO	NO	YES
Device settings > Alarm settings > Status classification > On/off valve			
All classifications	NO	The type of application is reset to 'On/off valve'.	

Parameters	Reset Code 36		
	Diag	Std	DS
Device settings > Alarm settings > Status classification > Supply pressure			
All classifications	NO	NO	YES
Device settings > Alarm settings > Status classification > Logging			
Supply pressure	NO	NO	YES
Change in friction	NO	NO	YES
Seat leakage	NO	NO	YES
Packing leakage	NO	NO	YES
Pneumatic leakage	NO	NO	YES
Defective actuator springs	NO	NO	YES
Manipulated variable range limitation	NO	NO	YES
Course of end position	NO	NO	YES
Positioner-valve linkage	NO	NO	YES
Manipulated variable range	NO	NO	YES
Change in manipulated variable range	NO	NO	YES
Partial stroke test (PST)	NO	NO	YES
Full stroke test (FST)	NO	NO	YES
On/off valve	NO	NO	YES
Code 50–58, 61, 63, 76, 81	NO	NO	YES
Binary input	NO	NO	YES
Data logger	NO	NO	YES
Internal solenoid valve/forced venting	NO	YES	YES
Min. interval for new logging of internal solenoid valve	NO	YES	YES
Diagnostics > Data logger			
Function	YES	YES	YES
Sampling time	YES	YES	YES
Triggered by	YES	YES	YES
Trigger value	YES	YES	YES
Trigger band	YES	YES	YES

Parameters	Reset Code 36		
	Diag	Std	DS
Trigger condition	YES	YES	YES
Trigger lead time	YES	YES	YES
Diagnostics > Monitoring/tests > Valve signature > Course of supply pressure			
Recording threshold	NO	YES	YES
Diagnostics > Monitoring/tests > Histograms > Valve position x histogram > Short-term monitoring			
Sampling time	YES	YES	YES
Diagnostics > Monitoring/tests > Histograms > Set point deviation e histogram > Short-term monitoring			
Sampling time	YES	YES	YES
Diagnostics > Monitoring/Tests > Leakage sensor > Short-term monitoring			
Sensitivity sound level	YES	NO	YES
Diagnostics > Monitoring/tests > Dynamic tests > Valve dead band			
Lower range value	YES	YES	YES
Stop	YES	YES	YES
Waiting time after step change	YES	YES	YES
No. until reversing	YES	YES	YES
Diagnostics > Monitoring/tests > Dynamic tests > Partial stroke test (PST)			
Enter test start (Code 49 - A2)	NO	NO	NO
Enter test interval (Code 49 - A3)	NO	YES	YES
Lower range value (Code 49 - d2)	NO	YES	YES
Stop (Code 49 - d3)	NO	YES	YES
Tolerance limit	NO	YES	YES
Activate ramp function (Code 49 - d4)	NO	YES	YES
Ramp time (decreasing) (Code 49 - d5)	NO	YES	YES
Ramp time (increasing) (Code 49 - d6)	NO	YES	YES
Settling time before starting test (Code 49 - d7)	NO	YES	YES
Waiting time after step change (Code 49 - d8)	NO	YES	YES

Parameters	Reset Code 36		
	Diag	Std	DS
Sampling time (Code 49 - d9)	YES	YES	YES
Max. test duration (Code 49 - E7)	YES	YES	YES
Activate 'Max. breakaway time'	NO	YES	YES
Max. breakaway time	NO	YES	YES
Activate 'Perm. time until step end'	NO	YES	YES
Perm. time until step end	NO	YES	YES
Activate x-monitoring (Code 49 - E0)	NO	YES	YES
x monitoring value (Code 49 - E1)	NO	YES	YES
Activate Δp out monitoring (Code 49 - A8)	NO	YES	YES
Δp out monitoring value (Code 49 - A9)	NO	YES	YES
Activate PST tolerance band monitoring (Code 49 - E5)	NO	YES	YES
PST tolerance band (Code 49 - E6)	NO	YES	YES
Diagnostics > Monitoring/tests > Dynamic tests > Full stroke test (FST)			
Tolerance limit	NO	YES	YES
Activate ramp function	NO	YES	YES
Ramp time (increasing)	NO	YES	YES
Ramp time (decreasing)	NO	YES	YES
Settling time before starting test	NO	YES	YES
Waiting time after step change	NO	YES	YES
Sampling time	YES	YES	YES
Max. test duration	YES	YES	YES
Activate 'Max. breakaway time'	NO	YES	YES
Max. breakaway time	NO	YES	YES
Activate 'Perm. time until CLOSED position exceeded'	NO	YES	YES
Perm. time until CLOSED position	NO	YES	YES
Diagnostics > Service/maintenance > Reset			
Desired time until 'Reset measured diagnostic data' (Code 48 - h3)	NO	NO	YES

Abbreviations used

- e Set point deviation
- p_{out} Signal pressure
- ps Supply pressure
- x Valve position
- x_0 Valve position when the valve is tightly shut
- w Set point, reference variable

EB 8389-1S EN



SAMSON AKTIENGESELLSCHAFT
Weismüllerstraße 3 · 60314 Frankfurt am Main, Germany
Phone: +49 69 4009-0 · Fax: +49 69 4009-1507
samson@samson.de · www.samson.de