

T 8135 EN

Series V2001 Valves · Type 3535 Three-way Valve for Heat Transfer Oil with electropneumatic, pneumatic or electric actuator

DIN version



Application

Mixing or diverting valves for heat transfer applications using organic media according to DIN 4754

Nominal size	DN 15 to 80
Pressure rating	PN 25
Temperature range	-10 to +350 °C

The Type 3535 Three-way Valve for Heat Transfer Oil (mixing or diverting valve) can be combined with either electric or pneumatic actuators:

- Electropneumatic actuator with integrated i/p positioner for Type 3535-IP
- Pneumatic actuators for Type 3535-PP
- Electric actuators for Type 3535-E1 or Type 3535-E3

Valve body materials

- Spheroidal graphite iron, cast steel or stainless steel for PN 16 and 25
- Nominal sizes DN 15 to 80

Special features

- Stem sealed by metal bellows and packing
- Metal-seated valve plug
- Mixing valves in DN 15 to 25 can also be used for diverting service.

The control valves can optionally be equipped with positioners, limit switches and resistance transmitters.

Versions

- **Type 3535-IP Electropneumatic Valve (mixing or diverting valve) for Heat Transfer Oil** (Fig. 1) · i/p positioner integrated into Type 3372 Electropneumatic Actuator, plug connector, tight-closing function for completely venting or filling the actuator with air, 4 to 20 mA reference variable, max. 4 bar supply air, fail-safe position actuator stem extends or retracts, optionally with Type 4744-2 Limit Switch
- **Type 3535-PP Pneumatic Valve (mixing or diverting valve) for Heat Transfer Oil** (Fig. 2) with Type 3371 Pneumatic Actuator, bench range 1.4 to 2.3 bar, optionally with Type 4744-2 Limit Switch
- **Type 3535-E1 Electric Valve (mixing or diverting valve) for Heat Transfer Oil** (Fig. 3) · Type 5827-N3 Electric Actuator, supply voltage 230 V/50 Hz or 24 V/50 Hz, optionally with limit contacts, resistance transmitter, positioner
- **Type 3535-E3 Electric Valve (mixing or diverting valve) for Heat Transfer Oil** (Fig. 4) · Type 3374 Electric Actua-

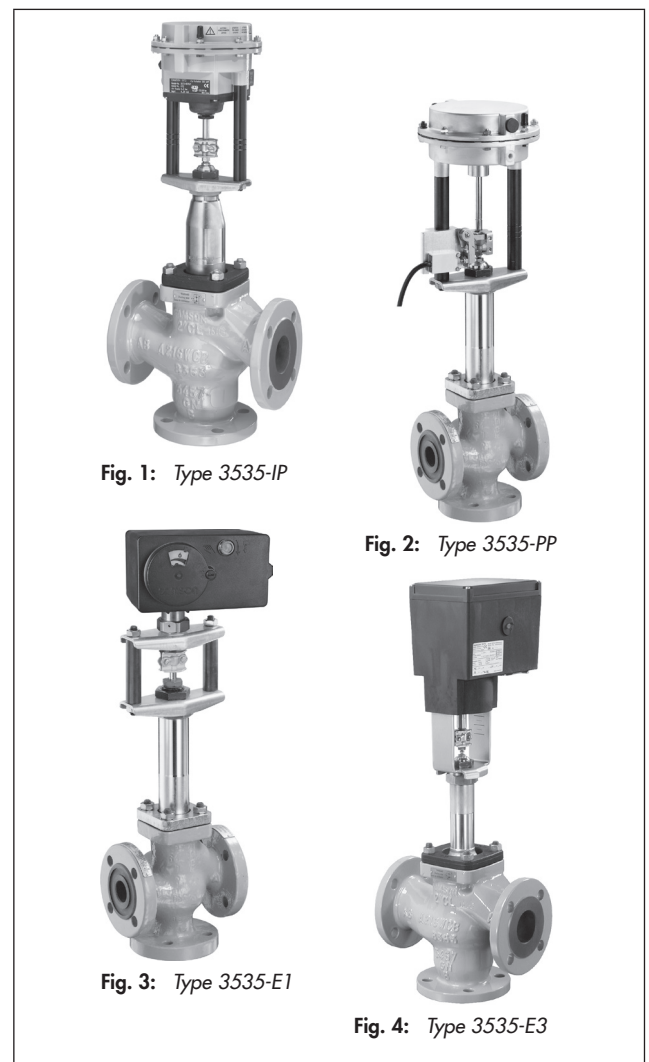

tor, supply voltage 230 V/50 Hz or 230 V/60 Hz and 24 V/50 Hz or 24 V/60 Hz, optionally with fail-safe action (typetested), limit contacts, resistance transmitter, positioner

Further versions

- **Type 3535** · Temperature range down to $-70\text{ }^{\circ}\text{C}$ · On request
- **Explosion-protected version** with electric actuators · On request
- **Type 3535 according to ANSI standards** · See Data Sheet
▶ T 8136

Principle of operation

Depending on the version, the three-way valve for heat transfer oil can be used either as a mixing or diverting valve.

In mixing valves, the process media to be mixed enter at valve ports A and B. The combined flow exits the valve at port AB (Fig. 6). The flow rate from ports A or B to AB depends on the cross-sectional area of flow between the seats and plugs. Mixing valves in nominal sizes DN 15 to 25 are also suitable for diverting service.

In diverting valves, the process medium enters at the valve port AB and the partial flows exit at ports A and B (Fig. 5). The plug stem is sealed by a metal bellows and an additional packing.

Fail-safe position with pneumatic actuators

Depending on how the springs are arranged in the electro-pneumatic or pneumatic actuator, the control valve has two different fail-safe positions that become effective when the supply air fails:

- **Actuator stem extends:** when the supply air fails, port B is closed in mixing valves and port A is closed in diverting valves.
- **Actuator stem retracts:** when the supply air fails, port A is closed in mixing valves and port B is closed in diverting valves.

Associated documentation

Instructions on how to mount the valve on the actuator can be found in the mounting and operating instructions delivered with the product:

- ▶ EB 8135/6 Type 3535 Three-way Valve for Heat Transfer Oil
- ▶ EB 8313 Pneumatic actuator for Type 3535-PP (mixing/diverting valve)
- ▶ EB 5827 Electric actuator for Type 3535-E1
- ▶ EB 8331-3 Electric actuator for Type 3535-E3
- ▶ EB 8331-4 Electric actuator for Type 3535-E3

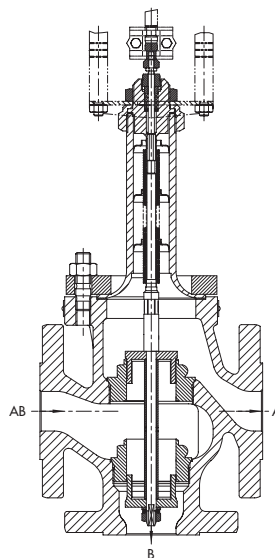

Fig. 5: Type 3535 Three-way Valve for Heat Transfer Oil · Plug arrangement for diverting service

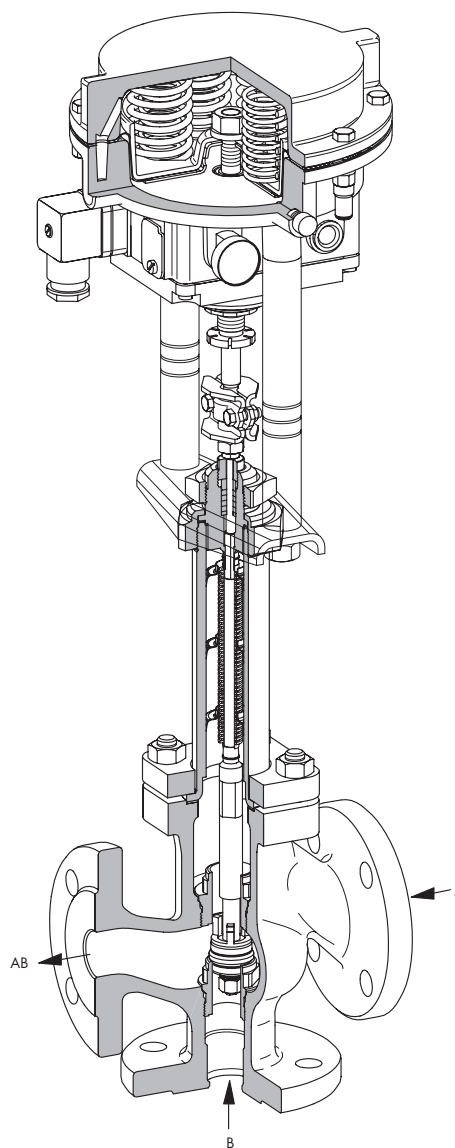

Fig. 6: Type 3535-IP Valve (mixing) for Heat Transfer Oil, pneumatic actuator with integrated electropneumatic positioner

Table 1: Type 3535 Three-way Valve for Heat Transfer Oil**Table 1.1: Technical data**

Nominal size	DN	15 · 20 · 25 · 32 · 40 · 50 · 65 · 80		
Material		Spheroidal graphite iron · EN-GJS-400-18-LT	Cast steel · 1.0619	Stainless steel · 1.4408
Connection	Flanges	EN 1092-1 form B1, Ra 3.2 to 12.5 µm · EN 1092-1, groove form D		
Pressure rating	PN	25		
Seat-plug seal		Metal seal		
Characteristic		Linear		
Rangeability		30:1 up to DN 25 · 50:1 for DN 32 and larger		
Temperature range		-10 (-70*) to +350 °C · *Extended temperature range lower than -70 °C on request		
Leakage class according to DIN EN 1349		Metal seal: I (0.05 % of K_{VS})		
Conformity		CE · EAC		

Table 1.2: Materials · (previous material designation written in parentheses)

Nominal size	DN	15 · 20 · 25 · 32 · 40 · 50 · 65 · 80		
Valve body		Spheroidal graphite iron · EN-GJS-400-18-LT	Cast steel · 1.0619	Stainless steel · 1.4408
Valve bonnet		1.0460		1.4408
Seat and plug	Bottom seat	DN 15 to 50: 1.4104 DN 65 to 80: 1.4006	DN 15 to 50: 1.4104 DN 65 to 80: 1.4401/1.4404	
	Top seat	DN 15 to 25: 1.4305 DN 32 to 50: 1.4104 DN 65 to 80: 1.4006	DN 15 to 25: 1.4305 DN 32 to 50: 1.4104 DN 65 to 80: 1.4401/1.4404	
	Plug	Up to DN 50: 1.4305 DN 65 and larger: 1.4006	Up to DN 50: 1.4305 DN 65 and larger: 1.4401/1.4404	
Bellows seal		1.4571		
Packing		PTFE		
Body gasket		Graphite on metal core		

Table 1.3: Nominal sizes, K_{VS} coefficients and seat diameters

Nominal size	DN	15	20	25	32	40	50	65	80
K_{VS}		4	6.3	8	16	20	32	50	80
Seat Ø	mm	24			40			65	
Rated travel	mm	15							

Table 1.4: K_{VS} coefficients and associated nominal sizes

K_{VS}	4	6.3	8	16	20	32	50	80
DN								
15	•							
20		•						
25			•					
32				•				
40					•			
50						•		
65							•	
80								•

Table 2: Pneumatic actuators**Table 2.1: Technical data**

Actuator		Electropneumatic actuator for Type 3535-IP	Pneumatic actuator for Type 3535-PP
Actuator area		120 cm ²	120 cm ²
Fail-safe action		Actuator stem extends or retracts	
Set point/bench range with fail-safe action	Extends	4 to 20 mA · Minimum current 3.6 mA Load impedance <6 V (300 Ω/20 mA) Direction of action >>, fixed	Bench range: 1.4 to 2.3 bar
	Retracts		Bench range: 1.4 to 2.3 bar
Characteristic		Linear · Deviation from terminal-based conformity ≤2 %	-
Hysteresis		≤1 %	
Variable position		≤7 %	
Transit time for rated travel	p _{perm} = 4 bar	Approx. 3 s	
Air consumption in steady state		≤160 l _n /h at p _{perm} = 4 bar	-
Degree of protection		IP54	-
Permissible ambient temperature		-30 to +70 °C	-35 to +90 °C
Additional electrical equipment		1 or 2 changeover contacts (IP 65, Ex d, 3 m cable) Nominal voltage/current: 250 V~/5 A~ or 250 V-/0.4 A-	

Table 2.2: Materials

Actuator housing		GD-Al Si 12		
Diaphragm		NBR		
Actuator stem		1.4305		
Positioner housing		POM-GF	-	Polyamide
Yoke	Stem	9SMn28K zinc-plated, matt black finish		-
	Crossbeam	1.4301		

Table 2.3: Permissible differential pressures for metal-seated plug · All pressures in bar

Fail-safe action		Actuator stem extends			Actuator stem retracts		
Bench range	bar	1.4 to 2.3			1.4 to 2.3		
Min./max. supply pressure	bar	3.7 to 4.0			3.7 to 4.0		
K _{VS} coefficients		Δp when p ₂ = 0 bar					
1.6 to 8		16	-	-	16	-	-
16 to 32		-	10	-	-	10	-
50 and 80		-	-	3.5	-	-	3.5

Table 3: *Electric actuators***Table 3.1:** *Technical data*

Actuator	for	Type 3535-E1	Type 3535-E3
Thrust		0.7 kN	2.5 kN Type 3374-11
Transit time for rated travel		90 s	120 s · Other transit times on request
Supply voltage	230 V/50 Hz	•	•
	230 V/60 Hz	–	•
	24 V/50 Hz	•	•
	24 V/60 Hz	–	•
Power consumption	Motor	3 VA	7.5 VA
	With positioner	3 VA · 8 VA	12.5 VA · 20 VA
Manual override		•	•
Degree of protection		IP 54 when installed upright	IP 54 · IP 65 with cable gland
	Mounting orientation	Suspended mounting not permitted (see ► EB 5827-1, ► EB 5827-2, ► EB 8331-3 and ► EB 8331-4)	
Permissible ambient temperature		0 to 50 °C	5 to 60 °C
Additional electrical equipment			
Limit contacts		2	2
Resistance transmitters (not for version with positioner)		1 0 to 1000 Ω	2 0 to 1000 Ω
Positioner		Digital	
Input signal		0/4 to 20 mA · 0/2 to 10 V	
Output signal		0/2 to 10 V	0/2 to 10 V · 0/4 to 20 mA

Table 3.2: *Permissible differential pressures for metal-seated plug · All pressures in bar*

Actuator	for	Type 3535-E1	Type 3535-E3
Thrust		0.7 kN	2.5 kN
	K_{Vs}	Δp when $p_2 = 0$ bar	
	4 to 8	10	16
	16 to 32	3.5	12
	50 and 80	–	4

Table 4: Dimensions in mm and weights in kg · Type 3535 Three-way Valve for Heat Transfer Oil**Table 4.1:** Type 3535-IP Electropneumatic Control Valve · Dimensions for version with actuator stem extends or retracts

Nominal size	DN	15	20	25	32	40	50	65	80	
L (face-to-face dimension)	mm	130	150	160	180	200	230	290	310	
Height										
H1 (stem extends)	mm	471			481			586		
H1 (stem retracts)	mm	556			566			671		
H2	mm	70	80	85	100	105	120	130	140	
H3 (stem extends)	mm	110			110			110		
H3 (stem retracts)	mm	210			210			210		
Weight	kg	8.7	9.2	10.2	16.7	17.2	19.7	30.7	35.7	

Table 4.2: Type 3535-PP Pneumatic Control Valve · Dimensions apply to both fail-safe positions

Nominal size	DN	15	20	25	32	40	50	65	80	
L (face-to-face dimension)	mm	130	150	160	180	200	230	290	310	
Height										
H1	mm	471			481			586		
H2	mm	70	80	85	100	105	120	130	140	
H3 (minimum distance)	mm	110			110			110		
Weight	kg	8.3	8.8	9.8	16.3	16.8	19.3	30.3	35.3	

Table 4.3: Type 3535-E1 Electric Control Valve

Nominal size	DN	15	20	25	32	40	50	65	80	
L (face-to-face dimension)	mm	130	150	160	180	200	230	-		
Height										
H1 Type 5827 Actuator	mm	432			442			-		
H2	mm	70	80	85	100	105	120			
H3 (minimum distance)	mm	110			110					
Weight	kg	6.8	7.3	8.3	14.8	15.3	17.8			

Table 4.4: Type 3535-E3 Electric Control Valve

Nominal size	DN	15	20	25	32	40	50	65	80	
L (face-to-face dimension)	mm	130	150	160	180	200	230	290	310	
Height										
H1	mm	529			539			644		
H2	mm	70	80	85	100	105	120	130	140	
H3 ¹⁾ (minimum distance)	mm	110			110			110		
Weight	kg	10.5	11	12	18.5	19	21.5	32.5	37.5	

¹⁾ Cover screws are mounted from the top.

Dimension diagrams for electropneumatic control valves

- 1 Pressure gauge G 1/8
- 2 Supply air G 1/4
- 3 Vent plug G 1/4

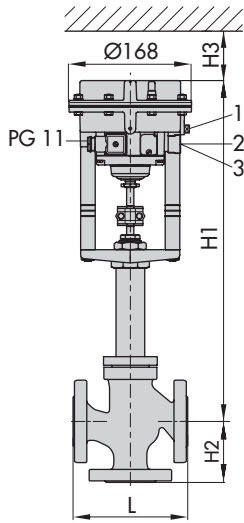

Type 3535-IP

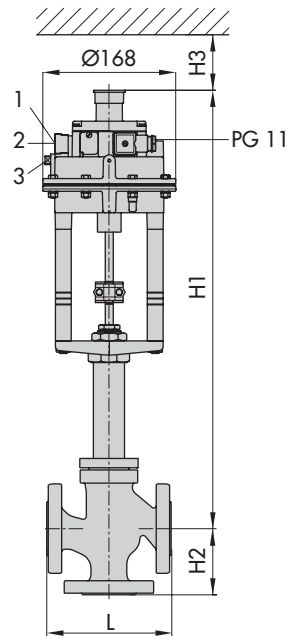

Type 3535-IP

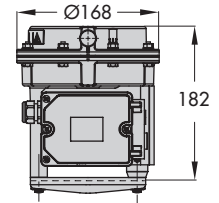

Type 3372 with Type 3725 Positioner

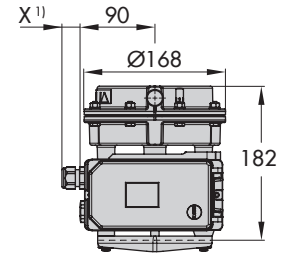

Type 3372 with Series 3730 Positioner

¹¹ The dimension X depends on the cable gland used.

Dimension diagrams for pneumatic control valves

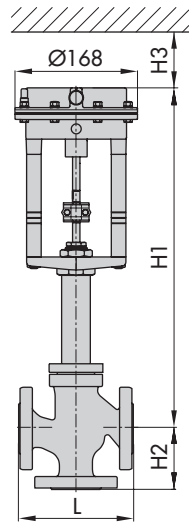

Type 3535-PP

Dimension diagrams for electric control valves

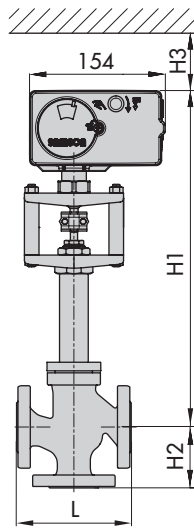

Type 3535-E1
Valve with Type 5827 Electric Actuator

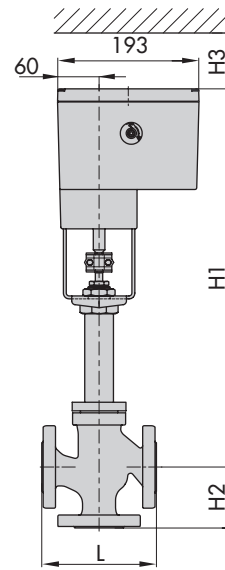

Type 3535-E3

Wiring plans

Type 5827 with positioner (► EB 5827-2)

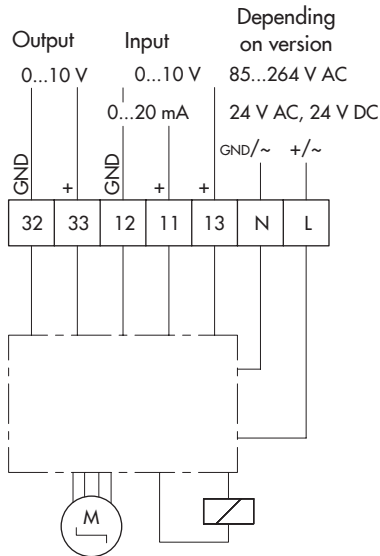

Limit contacts as additional function (in 24 V version only)

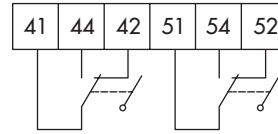

i Note

The 24 V version can be used either with a power supply of 24 V AC or 24 V DC.

Type 5827 with version with three-step signal (► EB 5827-1)

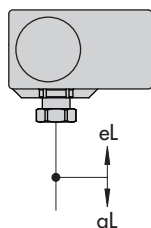
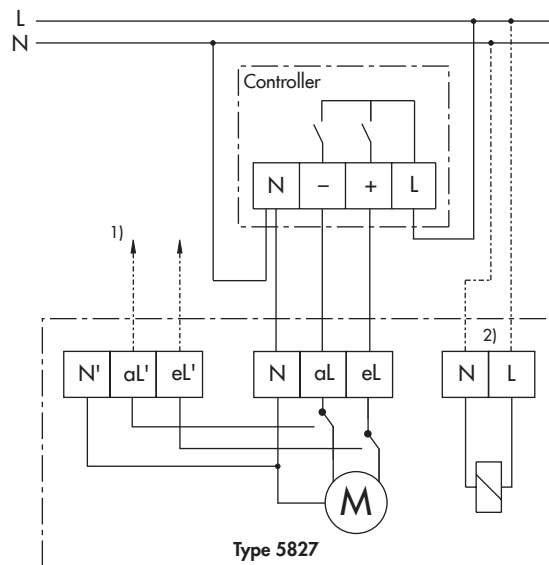

Additional electrical equipment

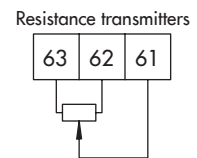
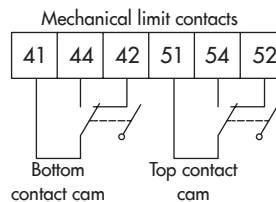

¹⁾ Signal feedforward for cascade control of several actuators after an actuator reaches its end position; "torque switch wired to terminals" version only

²⁾ Types 5827-A and 5827-E Actuators with fail-safe action only;

The 'N' connection is not connected to the N terminals for actuator control. As a result, it is possible to connect an external supply for 'L' and 'N' connections of the safety circuit.

Type 3374 with positioner (► EB 8331-4)

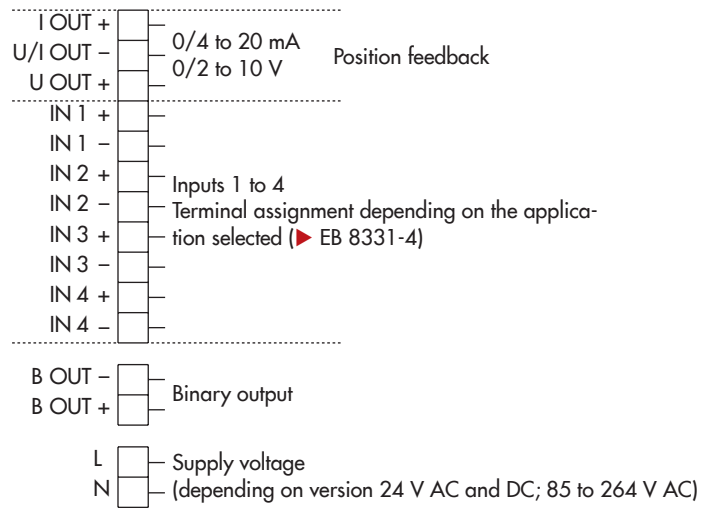

Options:

Mechanical limit contacts

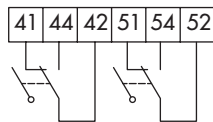

Electronic limit contacts

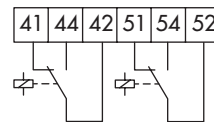

Type 3374 with version with three-step signal (► EB 8331-3)

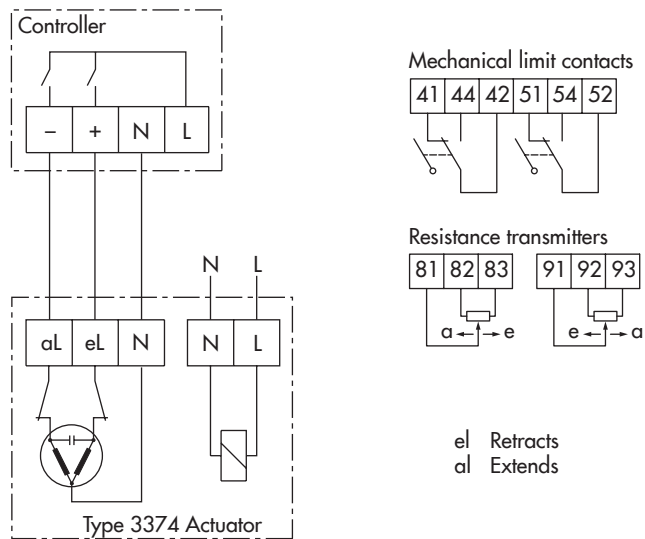

Ordering text

The following specifications are required on ordering:

Type 3535 Three-way Valve for Heat Transfer Oil

	Mixing or diverting valve
Nominal size	DN ...
Flow coefficients	K_{VS} ...
Pressure rating	PN ...
Body material	Spheroidal graphite iron, cast steel or stainless steel
Seat-plug seal	Metal seal

Actuators

For **Type 3535-IP**: Electropneumatic actuator with integrated positioner, 4 to 20 mA or with Type 3725/Series 3730 Positioner

Optional Intrinsically safe Ex ia IIC T6 according to ATEX

Additional equipment Limit switch 1 or 2

for **Type 3535-PP**: Pneumatic actuator

Fail-safe action Actuator stem extends or retracts

Bench range 1.4 to 2.3 bar

Additional equipment Limit switch 1 or 2

For **Type 3535-E1**: Type 5827 Electric Actuator

Supply voltage

Version with three-
step signal – 230 V/50 Hz
 – 24 V/50 Hz

Version with
positioner – 24 V/50 and 60 Hz and DC
 – 85 to 264 V/50 and 60 Hz

Additional equipment – 2 limit contacts
 – Resistance transmitter 0 to
 1000 Ω
 – Positioner
 input
 0/4 to 20 mA or 0/2 to 10 V
 – Output
 0/2 to 10 V

For **Type 3535-E3**: Electric actuator

Actuator thrust 2.5 kN
(without fail-safe ac-
tion only)

Supply voltage – 230 V/50 Hz
 – 230 V/60 Hz
 – 24 V/50 Hz
 – 24 V/60 Hz

Additional equipment – 2 limit contacts
 – Resistance transmitter 0 to
 1000 Ω
 – Digital positioner with input and
 output 0/4 to 20 mA or 0/2 to
 10 V

